

Keysight Wireless Connectivity Test Set

This help file provides documentation for the following products:
E6650A EXF Wireless Test Set for Femtocell

Notice: This document contains references to Agilent. Please note that Agilent's Test and Measurement business has become Keysight Technologies. For more information, go to www.keysight.com.

Notices

Copyright Notice

© Keysight Technologies 2014 - 2015

No part of this manual may be reproduced in any form or by any means (including electronic storage and retrieval or translation into a foreign language) without prior agreement and written consent from Keysight Technologies, Inc. as governed by United States and international copyright laws.

Manual Part Number

V9060-90001

Edition

Edition: 1, July 2015

Published by:

Keysight Technologies, Inc.
1400 Fountaingrove Parkway
Santa Rosa, CA 95403

Technology Licenses

The hardware and/or software described in this document are furnished under a license and may be used or copied only in accordance with the terms of such license.

U.S. Government Rights

The Software is “commercial computer software,” as defined by Federal Acquisition Regulation (“FAR”) 2.101. Pursuant to FAR 12.212 and 27.405-3 and Department of Defense FAR Supplement (“DFARS”) 227.7202, the US government acquires commercial computer software under the same terms by which the software is customarily provided to the public. Accordingly, Keysight provides the Software to US government customers under its standard commercial license, which is embodied in its End User License Agreement (EULA), a copy of which can be found at

<http://www.keysight.com/find/sweula>

The license set forth in the EULA represents the exclusive authority by which the US government may use, modify, distribute, or disclose the Software. The EULA and the license set forth therein, does not require or permit, among other things, that Keysight: (1) Furnish technical information related to commercial computer software or commercial computer software documentation that is not customarily provided to the public; or (2) Relinquish to, or otherwise provide, the government rights in excess of these rights customarily provided to the public to use, modify, reproduce, release, perform, display, or disclose commercial computer software or commercial computer software documentation. No additional government requirements beyond those set forth in the EULA shall apply, except to the extent that those terms, rights, or licenses are explicitly required from all providers of commercial computer software pursuant to the FAR and the DFARS and are set forth specifically in writing elsewhere in the EULA. Keysight shall be under no obligation to update, revise or otherwise modify the Software. With respect to any technical data as defined by FAR 2.101, pursuant to FAR 12.211 and 27.404.2 and DFARS 227.7102, the US government acquires no greater than Limited Rights as defined in FAR 27.401 or DFAR 227.7103-5 (c), as applicable in any technical data.

Warranty

THE MATERIAL CONTAINED IN THIS DOCUMENT IS PROVIDED “AS IS,” AND IS SUBJECT TO BEING CHANGED, WITHOUT NOTICE, IN FUTURE EDITIONS. FURTHER, TO THE MAXIMUM EXTENT PERMITTED BY APPLICABLE LAW, KEYSIGHT DISCLAIMS ALL WARRANTIES, EITHER EXPRESS OR IMPLIED, WITH REGARD TO THIS MANUAL AND ANY INFORMATION CONTAINED HEREIN, INCLUDING BUT NOT LIMITED TO THE IMPLIED WARRANTIES OF MERCHANTABILITY AND FITNESS FOR A PARTICULAR PURPOSE. KEYSIGHT SHALL NOT BE LIABLE FOR ERRORS OR FOR INCIDENTAL OR CONSEQUENTIAL DAMAGES IN CONNECTION WITH THE FURNISHING, USE, OR PERFORMANCE OF THIS DOCUMENT OR OF ANY INFORMATION CONTAINED HEREIN. SHOULD KEYSIGHT AND THE USER HAVE A SEPARATE WRITTEN AGREEMENT WITH WARRANTY TERMS COVERING THE MATERIAL IN THIS DOCUMENT THAT CONFLICT WITH THESE TERMS, THE WARRANTY TERMS IN THE SEPARATE AGREEMENT SHALL CONTROL.

Safety Information

CAUTION

A CAUTION notice denotes a hazard. It calls attention to an operating procedure, practice, or the like that, if not correctly performed or adhered to, could result in damage to the product or loss of important data. Do not proceed beyond a CAUTION notice until the indicated conditions are fully understood and met.

WARNING

A WARNING notice denotes a hazard. It calls attention to an operating procedure, practice, or the like that, if not correctly performed or adhered to, could result in personal injury or death. Do not proceed beyond a WARNING notice until the indicated conditions are fully understood and met.

Table of Contents

V9060B IQ Analyzer Mode User's & Programmer's Reference	i
Table of Contents	iii
1 About the Test Set	25
Installing Application Software	26
Viewing a License Key	26
Obtaining and Installing a License Key	26
Updating Measurement Application Software	26
EXF Options and Accessories	28
Front-Panel Features	29
Display Annotations	30
Rear-Panel Features	31
Window Control Keys	32
Multi-Window	32
Zoom	32
Next Window	32
Mouse and Keyboard Control	34
Right-Click	34
PC Keyboard	35
Instrument Security & Memory Volatility	39
2 About the IQ Analyzer Mode	41
What Does IQ Analyzer Mode Do?	42
3 Programming the Test Set	43
What Programming Information is Available?	44
List of SCPI Commands	45
STATus Subsystem	62
Detailed Description	62
What Are Status Registers	62
What Are Status Register SCPI Commands	63
How to Use the Status Registers	64
Using a Status Register	65
Using the Service Request (SRQ) Method	66
Generating a Service Request	66
Status Register System	67
The Status Byte Register	68
Standard Event Status Register	70
Operation and Questionable Status Registers	72
Operation Status Register	72
Questionable Status Register	72
STATus Subsystem Command Descriptions	73
Operation Register	73

Operation Condition Query	73
Operation Enable	74
Operation Event Query	74
Operation Negative Transition	74
Operation Positive Transition	75
Preset the Status Byte	75
Questionable Register	76
Questionable Condition	76
Questionable Enable	76
Questionable Event Query	77
Questionable Negative Transition	77
Questionable Positive Transition	77
Questionable Calibration Register	78
Questionable Calibration Condition	78
Questionable Calibration Enable	78
Questionable Calibration Event Query	79
Questionable Calibration Negative Transition	79
Questionable Calibration Positive Transition	80
Questionable Calibration Skipped Register	80
Questionable Calibration Extended Failure Register	80
Questionable Frequency Register	81
Questionable Frequency Condition	81
Questionable Frequency Enable	81
Questionable Frequency Event Query	82
Questionable Frequency Negative Transition	82
Questionable Frequency Positive Transition	82
Questionable Integrity Register	83
Questionable Integrity Condition	83
Questionable Integrity Enable	83
Questionable Integrity Event Query	84
Questionable Integrity Negative Transition	84
Questionable Integrity Positive Transition	85
Questionable Integrity Signal Register	85
Questionable Integrity Uncalibrated Register	85
Questionable Power Register	86
Questionable Power Condition	86
Questionable Power Enable	86
Questionable Power Event Query	87
Questionable Power Negative Transition	87
Questionable Power Positive Transition	87
Questionable Temperature Register	88
Questionable Temperature Condition	88
Questionable Temperature Enable	88

Questionable Temperature Event Query	89
Questionable Temperature Negative Transition	89
Questionable Temperature Positive Transition	90
Common Commands	91
All (Daily use)	91
Clear Status	93
Standard Event Status Enable	94
Standard Event Status Register Query	94
Identification Query	95
Operation Complete	95
Query Instrument Options	96
Recall Instrument State	96
*RST (Remote Command Only)	97
Save Instrument State	97
Service Request Enable	98
Status Byte Query	98
Trigger	98
Self Test Query	99
Wait-to-Continue	99
4 Input/Output Functions	101
Input/Output	102
Input/Output variables - Preset behavior	103
RF Input	104
Input Z Correction	104
RF Input Port	105
RF Input	106
RFIO1	106
RFIO2	106
External Gain	107
Ext Preamp	107
More Information	108
MS	109
BTS	110
Restore Input/Output Defaults	111
Corrections	111
Select Correction	112
Correction On/Off	112
Properties	113
Select Correction	113
Antenna Unit	114
Frequency Interpolation	116
Description	118
Comment	118

RF Port	118
Edit	121
Navigate	122
Frequency	122
Amplitude	123
Insert Point Below	123
Delete Point	123
Delete Correction	123
Apply Corrections	124
Delete All Corrections	124
Set (Replace) Data (Remote Command Only)	124
Merge Correction Data (Remote Command Only)	125
Remote Correction Data Set Commands	126
Set (Replace) Data (Remote Command Only)	126
Merge Correction Data (Remote Command Only)	126
Freq Ref In	127
Sense	129
Internal	129
External	129
Ext Ref Freq	129
RF Output & Test Set Config	130
RF Output	130
RF Output	131
RFIO1	131
RFIO2	131
HalfDuplex Config	132
RF Input	132
RF Output	132
Output Config	133
Trig Out	133
Polarity	134
Off	134
Sweeping (HSWP)	134
Measuring	134
Main Trigger	135
Gate Trigger	135
Gate	135
Odd/Even Trace Point	135
Trig Out	136
Off	136
Source Marker 1	136
Source Marker 2	137
Source Marker 3	137

Source Marker 4	137
Analog Out	137
More Information	138
Auto	138
Off	139
5 Mode Functions	141
Mode	142
More Information	143
Sequence Analyzer	144
IQ Analyzer (Basic)	144
W-CDMA with HSPA+	145
GSM/EDGE/EDGE Evo	145
TD-SCDMA with HSPA/8PSK	145
WLAN	146
89601 VSA	146
LTE	147
LTE TDD	147
Application Mode Number Selection (Remote Command Only)	147
Application Mode Catalog Query (Remote Command Only)	148
Application Identification (Remote Commands Only)	149
Current Application Model	149
Current Application Revision	149
Current Application Options	150
Application Identification Catalog (Remote Commands Only)	150
Application Catalog Number of Entries	150
Application Catalog Model Numbers	151
Application Catalog Revision	151
Application Catalog Options	151
Detailed List of Modes	152
89601 VSA	152
GSM/EDGE/EDGE Evo	153
IQ Analyzer (Basic)	153
LTE	153
LTE TDD	154
LTE-Advanced FDD	154
LTE-Advanced TDD	155
Sequence Analyzer	155
TD-SCDMA with HSPA/8PSK	155
W-CDMA with HSPA+	156
WLAN	156
Global Settings	156
Global Center Freq	156
Restore Defaults	157

Mode Setup	158
Restore Mode Defaults	158
Preset Type (Remote Command Only)	158
6 System Functions	159
File	160
File Explorer	160
Print	161
Maximize/Restore Down	161
Maximize	161
Restore Down	161
Page Setup	161
Print	162
Restore Down	163
Minimize	163
Exit	164
Print	165
System	166
Show	166
Errors	166
Previous Page	167
Next Page	168
History	168
Verbose SCPI On/Off	168
Refresh	169
Clear Error Queue	169
Status	169
Input Overload Enable (Remote Command Only)	169
Power Up (Remote Command Only)	170
System	170
Show System contents (Remote Command Only)	171
Computer System description (Remote Command Only)	171
Hardware	172
System Remote Commands (Remote Commands Only)	172
System Powerdown (Remote Command Only)	173
List installed Options (Remote Command Only)	173
Lock the Front-panel keys (Remote Command Only)	173
List SCPI Commands (Remote Command Only)	174
SCPI Version Query (Remote Command Only)	174
Date (Remote Command Only)	174
Time (Remote Command Only)	175
Module Name (Remote Command Only)	175
Module Index (Remote Command Only)	176
Module Mnemonic (Remote Command Only)	176

Module List (Remote Command Only)	176
Module Enable (Remote Command Only)	177
Module Default (Remote Command Only)	178
Module Model Number (Remote Command Only)	178
Module Model Serial Number (Remote Command Only)	179
Power On	179
Mode and Input/Output Defaults	180
User Preset	180
Last State	180
Power On Application	181
Configure Applications	182
Preloading Applications	182
Access to Configure Applications utility	182
Virtual memory usage	183
Select All	183
Deselect All	183
Move Up	184
Move Down	184
Select/Deselect	184
Save Changes and Exit	184
Exit Without Saving	185
Restore Power On Defaults	185
Configure Applications - Instrument boot-up	186
Configure Applications - Windows desktop	186
Configure Applications - Remote Commands	186
Configuration list (Remote Command Only)	186
Configuration Memory Available (Remote Command Only)	187
Configuration Memory Total (Remote Command Only)	187
Configuration Memory Used (Remote Command Only)	187
Configuration Application Memory (Remote Command Only)	187
Alignments	188
Align Now	188
All (Daily use)	188
All but RF	190
RF (Weekly use)	192
Source (Weekly use)	193
IF Alignment (Weekly use)	194
Show Alignment Statistics	196
Restore Align Defaults	198
Execute Expired Alignments (Remote Command Only)	199
I/O Config	200
SCPI LAN	200
SCPI Telnet	200

SCPI Socket	200
SICL Server	201
HiSLIP Server	202
SCPI Socket Control Port (Remote Command Only)	202
System IDN Response	203
Factory	203
User	203
Restore Defaults	204
Restore Input/Output Defaults	204
Restore Power On Defaults	205
Restore Align Defaults	205
Restore Misc Defaults	206
Restore Mode Defaults (All Modes)	207
All	208
Control Panel...	208
Licensing...	209
Security	211
USB	212
Read-Write	212
Read only	212
Diagnostics	213
Show Hardware Statistics	213
SCPI for Show Hardware Statistics (Remote Commands Only)	214
Advanced	214
Key Recorder	215
Self test	215
All Self Test	216
FEC Self Test	216
Show Result	216
Internet Explorer...	218
7 Trigger Functions	219
Trigger	220
Trigger Source Presets	221
RF Trigger Source	224
I/Q Trigger Source	225
More Information	226
Free Run	227
Video (IF Envelope)	228
Trigger Level	228
Trig Slope	229
Trig Delay	230
External 1	231
Trigger Level	232

Trig Slope	232
Trig Delay	233
Zero Span Delay Comp On/Off	234
External 2	234
Trigger Level	235
Trig Slope	235
Trig Delay	236
Zero Span Delay Comp On/Off	236
RF Burst	237
Absolute Trigger Level	238
Relative Trigger Level	239
Trigger Slope	240
Trig Delay	240
Periodic Timer (Frame Trigger)	241
Period	242
Offset	243
Offset Adjust (Remote Command Only)	244
Reset Offset Display	245
Sync Source	245
Off	246
External 1	246
External 2	248
RF Burst	249
Trig Delay	251
Auto/Holdoff	252
Auto Trig	252
Trig Holdoff	253
Holdoff Type	253
8 Complex Spectrum Measurement	255
AMPTD Y Scale	260
Ref Value (Spectrum window)	260
Range	260
Peak to Average	261
Mixer Level Offset	261
Scale/Div (Spectrum)	262
Ref Position (Spectrum)	262
Auto Scaling	263
Auto Couple	264
More Information	264
Auto/Man Active Function keys	264
Auto/Man 1-of-N keys	264
BW	266
Res BW	266

Cont (Continuous Measurement/Sweep)	267
File	269
Frequency/Channel	270
Center Freq	270
Center Frequency Presets	271
RF Center Freq	273
Ext Mix Center Freq	274
I/Q Center Freq	275
Input/Output	276
Marker	277
Select Marker	277
Marker Type	277
Properties	277
Select Marker	278
Relative To	278
Marker Trace	278
Couple Markers	279
All Markers Off	279
Marker X Axis Value (Remote Command Only)	280
Marker X Axis Position (Remote Command Only)	280
Marker Y Axis Value (Remote Command Only)	281
Backward Compatibility SCPI Commands	282
Marker Function	283
Select Marker	283
Marker Function Type	283
Band Adjust	283
Band/Interval Span for Frequency Domain	284
Band/Interval Left for Frequency Domain	284
Band/Interval Right for Frequency Domain	285
Marker To	286
Mkr -> CF	286
Mkr -> Ref Lvl	286
Meas	287
Remote Measurement Functions	287
Measurement Group of Commands	288
Current Measurement Query (Remote Command Only)	290
Limit Test Current Results (Remote Command Only)	290
Data Query (Remote Command Only)	290
Calculate/Compress Trace Data Query (Remote Command Only)	291
Calculate Peaks of Trace Data (Remote Command Only)	296
Format Data: Numeric Data (Remote Command Only)	297
Format Data: Byte Order (Remote Command Only)	298
Meas Setup	299

Avg/Hold Num	299
Avg Mode	299
Avg Type	300
Advanced	301
Digital IF BW	301
Filter Type	303
Filter Type	304
Sample Rate (Remote Command Only)	305
Filter Bandwidth	305
Channel Filter Alpha	306
FFT Window	307
FFT Size	307
Length Ctrl	307
Min Pnts/RBW	308
Window Length	308
FFT Length	309
Meas Preset	309
Mode	311
Mode Preset	312
How-To Preset	313
Mode Setup	315
Peak Search	316
More Information	316
Next Peak	316
Next Pk Right	317
Next Pk Left	317
Marker Delta	317
Mkr -> CF	318
Mkr -> Ref Lvl	318
Peak Criteria	318
“Peak Search” Criteria	319
Highest Peak	319
Same as “Next Peak” Criteria	320
“Next Peak” Criteria	320
Pk Excursion	320
Pk Threshold	321
Pk Threshold Line	322
Continuous Peak Search	323
More Information	324
Pk-Pk Search	324
Min Search	325
Print	326
Quick Save	327

Table of Contents

Recall	329
State	329
More Information	331
From File...	331
Edit Register Names	333
Register 1 thru Register 16	333
Register 1 thru Register 16	334
Sequences	335
Source Sequence	335
Open...	336
Data (Import)	336
Amplitude Correction	337
Amplitude Correction	338
Open...	338
Restart	339
More Information	339
Save	341
State	341
To File . . .	342
Edit Register Names	344
More Information	344
Register 1 thru Register 16	345
Register 1 thru Register 16	345
Mass Storage Catalog (Remote Command Only)	346
Mass Storage Change Directory (Remote Command Only)	346
Mass Storage Copy (Remote Command Only)	347
Mass Storage Device Copy (Remote Command Only)	347
Mass Storage Delete (Remote Command Only)	347
Mass Storage Data (Remote Command Only)	348
Mass Storage Make Directory (Remote Command Only)	348
Mass Storage Move (Remote Command Only)	348
Mass Storage Remove Directory (Remote Command Only)	349
Sequences	349
Source Sequence	349
Save As . . .	350
Data (Export)	350
Amplitude Correction	351
Correction Data File	351
Amplitude Correction	354
Measurement Results	354
Meas Results File Contents	355
Marker Table	355
Peak Table	358

Spectrogram	360
Save As . . .	365
Screen Image	366
Themes	367
3D Color	367
3D Monochrome	368
Flat Color	368
Flat Monochrome	368
Save As...	368
Single (Single Measurement/Sweep)	370
More Information	370
Source	371
RF Output	371
Amplitude	371
RF Power	372
RF Power Range	373
Set Reference Power	373
Power Ref	373
Amptd Offset	374
Modulation	375
Frequency	375
Frequency	376
Channel	376
GSM/EDGE Channel Number Ranges	377
W-CDMA Channel Number Ranges	378
CDMA 2000 / 1xEVDO Channel Number Ranges	379
LTE FDD Channel Number Ranges	381
LTE TDD Channel Number Ranges	383
TDSCDMA Channel Number Ranges	384
Radio Setup	385
Radio Standard	385
Radio Band Link	403
Set Reference Frequency	404
Freq Reference	405
Freq Offset	406
Modulation Setup	406
ARB	407
ARB	407
Select Waveform	408
ARB Setup	413
Trigger Type	421
Trigger Source	425
Trigger Initiate	426

Waveform Sequences	426
Waveform Utilities	437
Marker Utilities	447
Header Utilities	452
Bus Trigger Command (Remote Command Only)	453
AM	453
AM	454
AM Depth	454
AM Rate	454
FM	455
FM	455
FM Deviation	455
FM Rate	456
PM	456
PM	456
PM Deviation	456
PM Rate	457
List Sequencer	457
Sequencer	458
Initiate Sequence	458
List Sequencer Setup	459
Number of Steps	459
Current Step	459
Insert Step Before	459
Delete Step	460
Clear List	460
Step Trigger	460
Transition Time	462
Radio Setup	463
Channel	480
Frequency	480
Power	481
Waveform	482
Step Duration	488
Output Trigger	490
Step Configuration (Remote Command Only)	491
Clear List (Remote Command Only)	499
Trigger Type	499
BeginningOfStep	499
DataMarker	500
Manual Trigger Now	501
Remote Software Trigger (Remote command Only)	501
Query List Sequence Initiation Armed Status (Remote Command Only)	502

Source Preset	502
Span X Scale	503
Span (Spectrum View)	503
Sweep/Control	504
Pause/Resume	504
Abort (Remote Command Only)	504
System	506
Trace/Detector	506
Trigger	507
Free Run	507
Video	507
Trigger Level	507
Trig Slope	507
Trig Delay	507
External 1	507
Trigger Level	507
Trig Slope	507
Trig Delay	507
Zero Span Delay Comp	507
External 2	507
Trigger Level	507
Trig Slope	507
Trig Delay	508
Zero Span Delay Comp	508
RF Burst	508
Absolute Trigger	508
Relative Trigger	508
Trig Slope	508
Trig Delay	508
Periodic Timer	508
Period	508
Offset	508
Offset Adjust (Remote Command Only)	508
Reset Offset Display	508
Sync Source	508
Off	508
External 1	509
External 2	509
RF Burst	509
Trig Delay	509
Auto/Holdoff	509
Auto Trig	509
Trig Holdoff	509

Holdoff Type	509
User Preset	510
User Preset	510
User Preset All Modes	511
Save User Preset	512
View/Display	513
Display	513
Annotation	513
Meas Bar On/Off	514
Screen	515
Active Function Values On/Off	515
Title	516
Change Title	516
Clear Title	517
Graticule	518
System Display Settings	518
Annotation Local Settings	518
Themes	519
9 Waveform Measurement	521
AMPTD Y Scale	525
Ref Value (RF Envelope View)	525
Range	525
Peak to Average	526
Mixer Level Offset	526
Scale/Div (RF Envelope View)	527
Ref Position (RF Envelope View)	527
Auto Scaling	528
Auto Couple	530
More Information	530
Auto/Man Active Function keys	530
Auto/Man 1-of-N keys	530
BW	532
Digital IF BW	532
Filter Type	533
Filter BW	534
Filter Alpha	535
Cont (Continuous Measurement/Sweep)	536
File	538
Frequency/Channel	539
Center Freq	539
Center Frequency Presets	540
RF Center Freq	542
Ext Mix Center Freq	543

I/Q Center Freq	544
Input/Output	545
Marker	546
Select Marker	546
Marker Type	546
Properties	547
Select Marker	547
Relative To	547
Marker Trace	548
Couple Markers	548
All Markers Off	549
Marker X Axis Value (Remote Command Only)	549
Marker X Axis Position (Remote Command Only)	550
Marker Y Axis Value (Remote Command Only)	550
Marker ->	552
Marker Function	553
Select Marker	553
Marker Function Type	553
Band Adjust	554
Band/Interval Span for Time Domain	554
Band/Interval Left for Time Domain	555
Band/Interval Right for Time Domain	555
Meas	557
Remote Measurement Functions	557
Measurement Group of Commands	558
Current Measurement Query (Remote Command Only)	560
Limit Test Current Results (Remote Command Only)	560
Data Query (Remote Command Only)	560
Calculate/Compress Trace Data Query (Remote Command Only)	561
Calculate Peaks of Trace Data (Remote Command Only)	566
Format Data: Numeric Data (Remote Command Only)	567
Format Data: Byte Order (Remote Command Only)	568
Meas Setup	569
Average/Hold Num	569
Avg Mode	569
Avg Type	570
Avg Type Auto	570
Meas Time	571
Sample Rate	572
Meas Preset	572
Sample Period (Aperture) Setting (Remote Command Only)	573
Mode	574
Mode Preset	575

How-To Preset	576
Mode Setup	578
Peak Search	579
Next Peak	579
Min Search	579
Print	581
Quick Save	582
Recall	584
State	584
More Information	586
From File...	586
Edit Register Names	588
Register 1 thru Register 16	588
Register 1 thru Register 16	589
Sequences	590
Source Sequence	590
Open...	591
Data (Import)	591
Amplitude Correction	592
Amplitude Correction	593
Open...	593
Restart	594
More Information	594
Save	596
State	596
To File . . .	597
Edit Register Names	599
More Information	599
Register 1 thru Register 16	600
Register 1 thru Register 16	600
Mass Storage Catalog (Remote Command Only)	601
Mass Storage Change Directory (Remote Command Only)	601
Mass Storage Copy (Remote Command Only)	602
Mass Storage Device Copy (Remote Command Only)	602
Mass Storage Delete (Remote Command Only)	602
Mass Storage Data (Remote Command Only)	603
Mass Storage Make Directory (Remote Command Only)	603
Mass Storage Move (Remote Command Only)	603
Mass Storage Remove Directory (Remote Command Only)	604
Sequences	604
Source Sequence	604
Save As . . .	605
Data (Export)	605

Amplitude Correction	606
Correction Data File	606
Amplitude Correction	609
Measurement Results	609
Meas Results File Contents	610
Marker Table	610
Peak Table	613
Spectrogram	615
Save As . . .	620
Screen Image	621
Themes	622
3D Color	622
3D Monochrome	623
Flat Color	623
Flat Monochrome	623
Save As...	623
Single (Single Measurement/Sweep)	625
More Information	625
Source	626
RF Output	626
Amplitude	626
RF Power	627
RF Power Range	628
Set Reference Power	628
Power Ref	628
Amptd Offset	629
Modulation	630
Frequency	630
Frequency	631
Channel	631
GSM/EDGE Channel Number Ranges	632
W-CDMA Channel Number Ranges	633
CDMA 2000 / 1xEVDO Channel Number Ranges	634
LTE FDD Channel Number Ranges	636
LTE TDD Channel Number Ranges	638
TDSCDMA Channel Number Ranges	639
Radio Setup	640
Radio Standard	640
Radio Band Link	658
Set Reference Frequency	659
Freq Reference	660
Freq Offset	661
Modulation Setup	661

ARB	662
ARB	662
Select Waveform	663
ARB Setup	668
Trigger Type	676
Trigger Source	680
Trigger Initiate	681
Waveform Sequences	681
Waveform Utilities	692
Marker Utilities	702
Header Utilities	707
Bus Trigger Command (Remote Command Only)	708
AM	708
AM	709
AM Depth	709
AM Rate	709
FM	710
FM	710
FM Deviation	710
FM Rate	711
PM	711
PM	711
PM Deviation	711
PM Rate	712
List Sequencer	712
Sequencer	713
Initiate Sequence	713
List Sequencer Setup	714
Number of Steps	714
Current Step	714
Insert Step Before	714
Delete Step	715
Clear List	715
Step Trigger	715
Transition Time	717
Radio Setup	718
Channel	735
Frequency	735
Power	736
Waveform	737
Step Duration	743
Output Trigger	745
Step Configuration (Remote Command Only)	746

Clear List (Remote Command Only)	754
Trigger Type	754
BeginningOfStep	754
DataMarker	755
Manual Trigger Now	756
Remote Software Trigger (Remote command Only)	756
Query List Sequence Initiation Armed Status (Remote Command Only)	757
Source Preset	757
Span X Scale	758
Ref Value	758
Scale/Div	758
Ref Position	759
Auto Scaling	759
Sweep/Control	761
Pause/Resume	761
Abort (Remote Command Only)	761
System	763
Trace/Detector	764
Trigger	765
Free Run	765
Video	765
Trigger Level	765
Trig Slope	765
Trig Delay	765
External 1	765
Trigger Level	765
Trig Slope	765
Trig Delay	765
Zero Span Delay Comp	765
External 2	765
Trigger Level	765
Trig Slope	765
Trig Delay	766
Zero Span Delay Comp	766
RF Burst	766
Absolute Trigger	766
Relative Trigger	766
Trig Slope	766
Trig Delay	766
Periodic Timer	766
Period	766
Offset	766
Offset Adjust (Remote Command Only)	766

Reset Offset Display	766
Sync Source	766
Off	766
External 1	767
External 2	767
RF Burst	767
Trig Delay	767
Auto/Holdoff	767
Auto Trig	767
Trig Holdoff	767
Holdoff Type	767
User Preset	768
User Preset	768
User Preset All Modes	769
Save User Preset	770
View/Display	771
View Selection by name (Remote Command Only)	771
View Selection by number (Remote Command Only)	771
Display	772
Annotation	772
Meas Bar On/Off	773
Screen	774
Active Function Values On/Off	774
Title	775
Change Title	775
Clear Title	776
Graticule	777
System Display Settings	777
Annotation Local Settings	777
Themes	778
RF Envelope	779
I/Q Waveform	781

1 About the Test Set

The X-Series E6650A EXF Wireless Test Set for Femtocell is a one-box tester consisting of instruments loaded into a M9018A PXI mainframe with a front impact cover. The mainframe has a common PC controller (located on the far left) and M9300A PXI Frequency Reference (located in the center of the rack). The test set has one to four Keysight M9440A TRX (transmit/receive) instruments installed.

Each TRX includes a signal analyzer and a signal source, both of which interface with the front panel of the test set through an input/output matrix, and is run by its own instance of the XSA firmware application (a fully loaded test set shows four independent XSA windows on its monitor display).

The E6650A can be configured to test cellular products with a standard 40 MHz of analysis bandwidth. It could also be configured to test Wireless products with 80 or 160 MHz of analysis bandwidth. If your requirement is to test both, the TRX instruments can be configured to test both products.

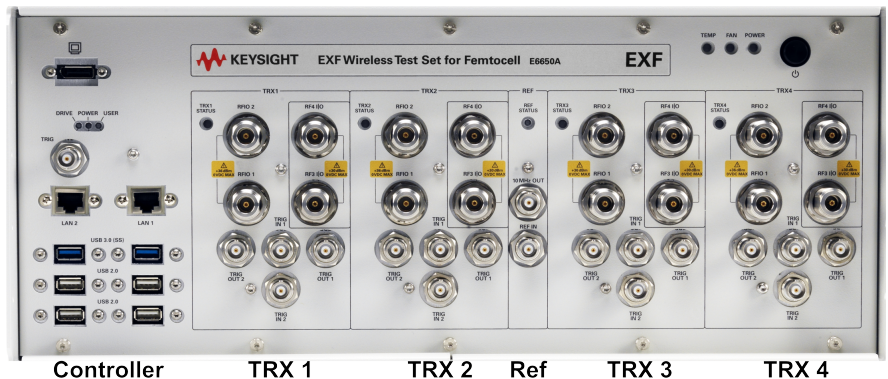

Installing Application Software

If you want to install a measurement application after your initial hardware purchase, you need only to license it. All of the available applications are loaded in your test set at the time of purchase.

Thus, when you purchase a new application, you will receive an entitlement certificate that you can use to obtain a license key for that application. To activate the new measurement application, enter the license key that you obtain into the test set.

For the latest information on Keysight X-series measurement applications and upgrade kits, visit the following internet URL.

<http://www.keysight.com/find/e6650a>

Viewing a License Key

Measurement applications that you purchased with your instrument have been installed and activated at the factory before shipment. The instrument requires a unique License Key for every measurement application purchased. The license key is a hexadecimal string that is specific to your measurement application, instrument model number and serial number. It enables you to install, or reactivate, that particular application.

Press **System, Show, System** to display the measurement applications that are currently licensed in your analyzer.

Go to the following location to view the license keys for the installed measurement applications:

```
C:\Program Files\Agilent\Licensing
```

You may want to keep a copy of your license key in a secure location. To do this, you can print out a copy of the display showing the license numbers. If you should lose your license key, call your nearest Keysight Technologies service or sales office for assistance.

Obtaining and Installing a License Key

If you purchase an additional application that requires installation, you will receive an "Entitlement Certificate", which may be redeemed for a license key for one instrument. To obtain your license key, follow the instructions that accompany the certificate.

Installing a license key for the selected application can be done automatically using a USB memory device. To do this, you copy the license file to the USB memory device, at the root level. Follow the instructions that come with your software installation kit.

Installing a license key can also be done manually using the built-in license management application, which may be found via the instrument front panel keys at **System, Licensing. . .**, or on-disk at:

```
C:\Programming Files\Agilent\Licensing
```

You can also use these procedures to reinstall a license key that has been accidentally deleted, or lost due to a memory failure.

Updating Measurement Application Software

All the software applications were loaded at the time of original instrument manufacture. It is a good idea to regularly update your software with the latest available version. This helps to ensure that you receive

any improvements and expanded functionality.

Because the software was loaded at the initial purchase, further additional measurement applications may now be available. If the application you are interested in licensing is not available, you will need to do a software update. (To display a list of installed applications, press **System, Show, System.**)

Check the appropriate page of the Keysight web site for the latest available software versions, according to the name of your instrument, as follows:

http://www.keysight.com/find/E6650A_software

You can load the updated software package into the analyzer either from a USB drive or directly from the internet. An automatic loading program is included with the files.

EXF Options and Accessories

You can view an online list of available Options and Accessories for your instrument as follows:

1. Browse to one of the following URLs, according to the product name of your analyzer:
www.keysight.com/find/e6650a
2. The home page for your instrument appears (in some cases, you may see an initial splash screen containing a button named View the Webpage, which you should click to display the home page).
3. Locate the **Options & Accessories** tab, as highlighted in the example below, which shows the home page for the E6650A.
4. Click the **Options & Accessories** tab, to display a list of available options and accessories for your instrument.

Front-Panel Features

The instrument Front-panel features are fully detailed in the section "Front-Panel Features" (under the chapter "Front and Rear Panel Features") of the document:

Latest available on line document: [E6650A Getting Started Guide](#)

Embedded PDF installed with the latest firmware revision:

If you are viewing this information as a Help file in the instrument, then you can click on the link above to open the PDF document.

Display Annotations

Display Annotations are fully detailed under the chapter "Front and Rear Panel Features" of the document:

Latest available on line document: [E6640A Getting Started Guide](#)

Embedded PDF installed with the latest firmware revision:

If you are viewing this information as a Help file in the instrument, then you can click on the links above to open the PDF document.

Rear-Panel Features

The instrument's Rear-panel features are fully detailed in the section "Rear-Panel Features" (under the chapter "Front and Rear Panel Features") of the document:

Latest available on line document: [E6650A Getting Started Guide](#)

Embedded PDF installed with the latest firmware revision:

If you are viewing this information as a Help file in the instrument, then you can click on the link above to open the PDF document.

Window Control Keys

Multi-Window

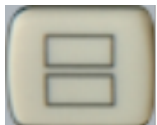

The **Multi Window** front-panel key will toggle you back and forth between the Normal View and the last Multi Window View (Zone Span, Trace Zoom or Spectrogram) that you were in, when using the Swept SA measurement of the Spectrum Analyzer Mode. It remembers which View you were in through a Preset. This “previous view” is set to Zone Span on a Restore Mode Defaults.

Key Path	Front-panel key
Initial S/W Revision	Prior to A.02.00

Zoom

Zoom is a toggle function. Pressing this key once increases the size of the selected window. Pressing the key again returns the window to the original size.

When Zoom is on for a window, that window will get the entire primary display area. The zoomed window, since it is the selected window, is outlined in green.

Zoom is local to each Measurement. Each Measurement remembers its Zoom state. The Zoom state of each Measurement is part of the Mode’s state.

NOTE

Data acquisition and processing for the other windows continues while a window is zoomed, as does all SCPI communication with the other windows.

Remote Command	:DISPlay:WINDow:FORMat:ZOOM
Remote Command	:DISPlay:WINDow:FORMat:TILE
Example	:DISP:WIND:FORM:ZOOM sets zoomed :DISP:WIND:FORM:TILE sets un-zoomed
Preset	TILE
Initial S/W Revision	Prior to A.02.00

Next Window

Selects the next window of the current view. When the Next Window key is pressed, the next window in the order of precedence becomes selected. If the selected window was zoomed, the next window will also be zoomed.

The window numbers are as follows. Note that these numbers also determine the order of precedence (that is, Next Window goes from 1 to 2, then 2 to 3, etc.):

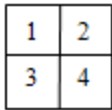

Four window display

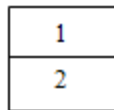

Two window display

RTSA measurements:

Only two windows are available in the Spectrogram view under the Spectrum measurement and up to three windows are available in the Power vs. Time measurement, depending on the view set up.

Remote Command	:DISPlay:WINDow[:SElect] <number> :DISPlay:WINDow[:SElect]?
Example	:DISP:WIND 1
Preset	1
Min	1
Max	If <number> is greater than the number of windows, limit to <number of windows>
Initial S/W Revision	Prior to A.02.00

One and only one window is always selected. The selected window has the focus; this means that all window-specific key presses apply only to that window. You can tell which window is selected by the thick green border around it. If a window is not selected, its boundary is gray.

If a window in a multi-window display is zoomed it is still outlined in green. If there is only one window, the green outline is not used. This allows the user to distinguish between a zoomed window and a display with only one window.

The selected window is local to each Measurement. Each Measurement remembers which window is selected. The selected window for each Measurement is remembered in Mode state.

NOTE

When this key is pressed in Help Mode, it toggles focus between the table of contents window and the topic pane window.

Mouse and Keyboard Control

If you do not have access to the instrument front-panel, there are several ways that a mouse and PC Keyboard can give you access to functions normally accessed using the front-panel keys.

For instrument lacking a physical front panel display, you can watch the instrument display via external monitor or remote desktop connection

Right-Click

If you plug in a mouse and right-click on the analyzer screen, a menu will appear as below:

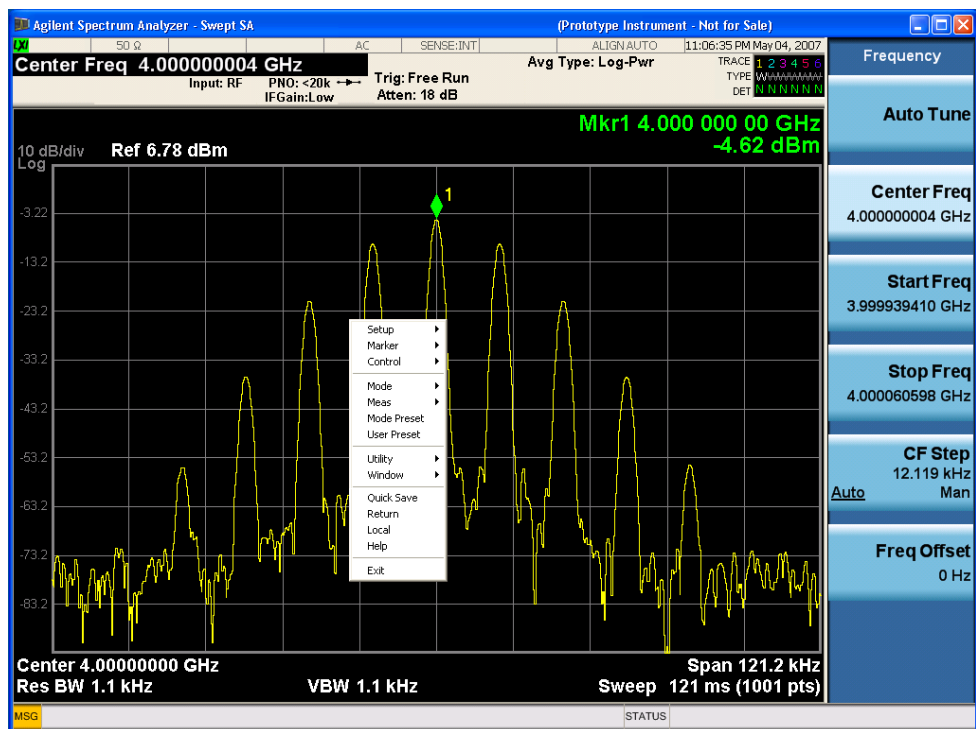

Placing the mouse on one of the rows marked with a right arrow symbol will cause that row to expand, as for example below where the mouse is hovered over the “Utility” row:

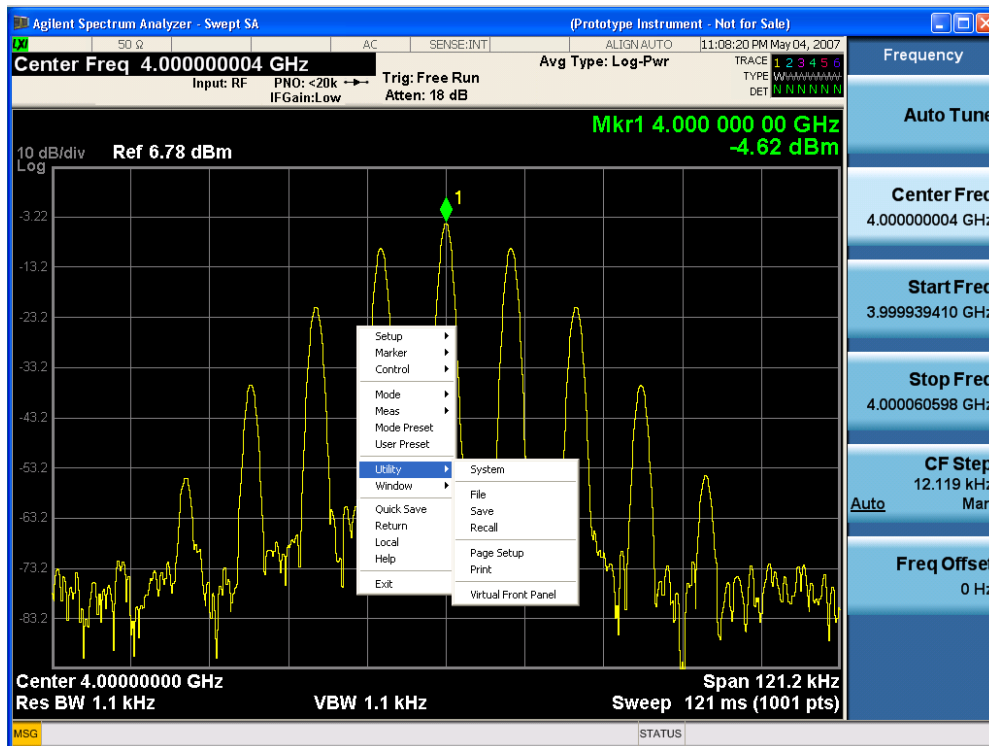

This method can be used to access any of the front-panel keys by using a mouse; as for example if you are accessing the instrument through Remote Desktop.

The array of keys thus available is shown below:

PC Keyboard

If you have a PC keyboard plugged in (or via Remote Desktop), certain key codes on the PC keyboard map to front-panel keys on the GPSA front panel. These key codes are shown below:

Front-panel key	Key code
Frequency	CTRL+SHIFT+F
Span	CTRL+SHIFT+S
Amplitude	CTRL+SHIFT+A
Input/Output	CTRL+SHIFT+O
View/Display	CTRL+SHIFT+V
Trace/Detector	CTRL+ALT+T
Auto Couple	CTRL+SHIFT+C
Bandwidth	CTRL+ALT+B
Source	CTRL+ALT-U
Marker	CTRL+ALT+K
Peak Search	CTRL+ALT+P
Marker To	CTRL+ALT+N

1 About the Test Set
 Mouse and Keyboard Control

Front-panel key	Key code
Marker Function	CTRL+ALT+F
System	CTRL+SHIFT+Y
Quick Save	CTRL+Q
Save	CTRL+S
Recall	CTRL+R
Mode Preset	CTRL+M
User Preset	CTRL+U
Print	CTRL+P
File	CTRL+SHIFT+L
Mode	CTRL+SHIFT+M
Measure	CTRL+ALT+M
Mode Setup	CTRL+SHIFT+E
Meas Setup	CTRL+ALT+E
Trigger	CTRL+SHIFT+T
Sweep/Control	CTRL+SHIFT+W
Restart	CTRL+ALT+R
Single	CTRL+ALT+S
Cont	CTRL+ALT+C
Zoom	CTRL+SHIFT+Z
Next Window	CTRL+SHIFT+N
Split Screen	CTRL+L
Full Screen	CTRL+SHIFT+B
Return	CTRL+SHIFT+R
Mute	Mute
Inc Audio	Volume Up
Dec Audio	Volume Down
Help	F1
Control	CTRL
Alt	ALT
Enter	Return
Cancel	Esc
Del	Delete
Backspace	Backspace
Select	Space
Up Arrow	Up
Down Arrow	Down

Front-panel key	Key code
Left Arrow	Left
Right Arrow	Right
Menu key 1	CTRL+SHIFT+F1
Menu key 2	CTRL+SHIFT+F2
Menu key 3	CTRL+SHIFT+F3
Menu key 4	CTRL+SHIFT+F4
Menu key 5	CTRL+SHIFT+F5
Menu key 6	CTRL+SHIFT+F6
Menu key 7	CTRL+SHIFT+F7
Backspace	BACKSPACE
Enter	ENTER
Tab	Tab
1	1
2	2
3	3
4	4
5	5
6	6
7	7
8	8
9	9
0	0

This is a pictorial view of the table:

1 About the Test Set
 Mouse and Keyboard Control

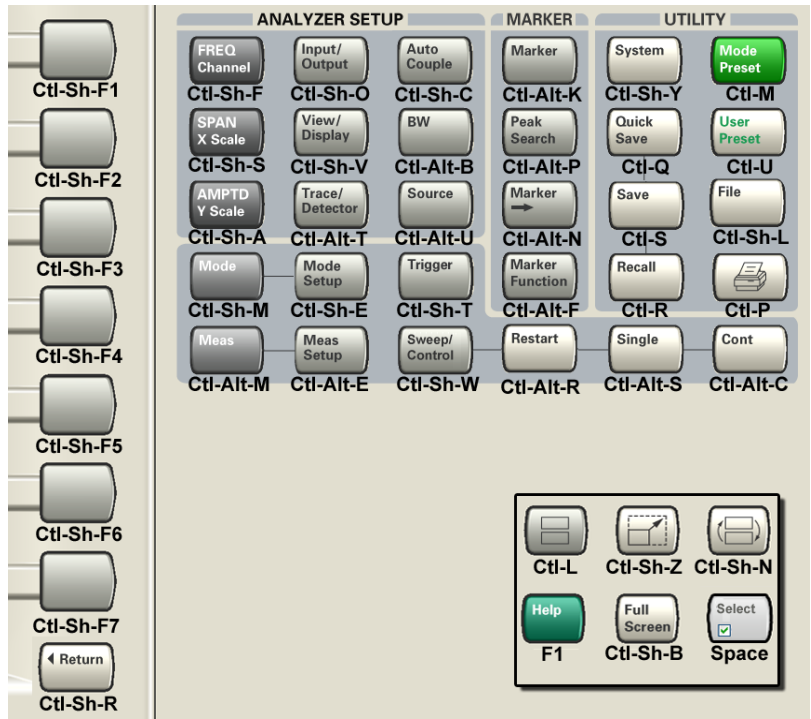

Instrument Security & Memory Volatility

If you are using the instrument in a secure environment, you may need details of how to clear or sanitize its memory, in compliance with published security standards of the United States Department of Defense, or other similar authorities.

For X-Series test sets, this information is contained in the document "Security Features and Document of Volatility". This document is not included in the instrument on-disk library, but it may be downloaded from the Keysight web site.

To obtain a copy of the document, click on or browse to the following URL:

<http://www.keysight.com/find/security>

To locate and download the document, select Model Number, for example "E6607A", then click "Submit". Then, follow the on-screen instructions to download the file.

(Undefined variable: Primary.ProductName)
IQ Analyzer Mode Reference

2 About the IQ Analyzer Mode

This chapter provides information on using the IQ Analyzer Mode in your Keysight Test Set.

What Does IQ Analyzer Mode Do?

The IQ Analyzer Mode makes frequency domain and time domain measurements. These measurements often use alternate hardware signal paths when compared with a similar measurement in the Signal Analysis Mode using the Swept SA measurement. These frequency domain and time domain measurements can be used to output I/Q data results when measuring complex modulated digital signals.

- Complex Spectrum Measurement (Frequency Domain)

This measurement is comparable to a precision microwave spectrum analyzer measurement that also provides demodulated I/Q data for individual I and Q amplitude data pairs.

- I/Q Waveform Measurement (Time Domain)

This measurement is comparable to a precision vector signal analyzer measurement that also provides demodulated I/Q data for individual magnitude and phase analysis.

(Undefined variable: Primary.ProductName)
IQ Analyzer Mode Reference

3 Programming the Test Set

This section provides introductory information about the programming documentation included with your product.

["What Programming Information is Available?" on page 44](#)

["STATus Subsystem " on page 62](#)

["Common Commands" on page 91](#)

What Programming Information is Available?

The X-Series Documentation can be accessed through the Additional Documentation page in the instrument Help system. It can also be found online at: <http://www.keysight.com/find/exf>.

The following resources are available to help you create programs for automating your X-Series measurements:

Resource	Description
X-Series Programmer's Guide	<p>Provides general SCPI programming information on the following topics:</p> <ul style="list-style-type: none">• Programming the X-Series Applications• Programming fundamentals• Programming examples <p>Note that SCPI command descriptions for measurement applications are not in this book, but are in the User's and Programmer's Reference.</p>
User's and Programmer's Reference manuals	<p>Describes all front-panel keys and softkeys, including SCPI commands for a measurement application. Note that:</p> <ul style="list-style-type: none">• Each measurement application has its own User's and Programmer's Reference.• The content in this manual is duplicated in the analyzer's Help (the Help that you see for a key is identical to what you see in this manual).
Embedded Help in your instrument	<p>Describes all front-panel keys and softkeys, including SCPI commands, for a measurement application. Note that the content that you see in Help when you press a key is identical to what you see in the User's and Programmer's Reference.</p>
X-Series Getting Started Guide	<p>Provides valuable sections related to programming including:</p> <ul style="list-style-type: none">• Licensing New Measurement Application Software - After Initial Purchase• Configuring instrument LAN Hostname, IP Address, and Gateway Address• Using the Windows XP Remote Desktop to connect to the instrument remotely• Using the Embedded Web Server Telnet connection to communicate SCPI <p>This printed document is shipped with the instrument.</p>
Keysight Application Notes	<p>Printable PDF versions of pertinent application notes.</p>
Keysight VISA User's Guide	<p>Describes the Keysight Virtual Instrument Software Architecture (VISA) library and shows how to use it to develop I/O applications and instrument drivers on Windows PCs.</p>

List of SCPI Commands

```

*CAL?
*CLS
*ESE <integer>
*ESE?
*ESR?
*IDN?
*OPC
*OPC?
*OPT?
*RCL <register#>
*RST
*SAV <register#>
*SRE <integer>
*SRE?
*STB?
*TRG
*TST?
*WAI
ABORT
CALCulate:CLIMits:FAIL?
CALCulate:DATA<n>:COMPRESS? BLOCK | CFIT | MAXimum | MINimum | MEAN |
DMEan | RMS | RMSCubed | SAMPLE | SDEVIation | PPHase[, <soffset>[,
<length>[, <roffset>[, <rlimit>]]]]
CALCulate:DATA[n]?
CALCulate:DATA[1]|2|...|6:PEAKs? <threshold>, <excursion>[, AMPLitude |
FREQuency | TIME]
CALCulate:DATA[1]|2|...|6:PEAKs? <threshold>, <excursion>[, AMPLitude |
FREQuency | TIME[, ALL | GTDLine | LTDLine]]
CALCulate:SPECTrum:MARKer:AOff
CALCulate:SPECTrum:MARKer:COUple[:STATE] ON | OFF | 1 | 0
CALCulate:SPECTrum:MARKer:COUple[:STATE]?
CALCulate:SPECTrum:MARKer[1]|2|...|12:CPSearch[:STATE] ON | OFF | 1 | 0
CALCulate:SPECTrum:MARKer[1]|2|...|12:CPSearch[:STATE]?
CALCulate:SPECTrum:MARKer[1]|2|...|12:FUNCTion NOISE | BPOWER | BDENSITY |
OFF
CALCulate:SPECTrum:MARKer[1]|2|...|12:FUNCTion?
CALCulate:SPECTrum:MARKer[1]|2|...|12:FUNCTion:BAND:LEFT <freq>
CALCulate:SPECTrum:MARKer[1]|2|...|12:FUNCTion:BAND:LEFT?
CALCulate:SPECTrum:MARKer[1]|2|...|12:FUNCTion:BAND:RIGHT <freq>
CALCulate:SPECTrum:MARKer[1]|2|...|12:FUNCTion:BAND:RIGHT?
CALCulate:SPECTrum:MARKer[1]|2|...|12:FUNCTion:BAND:SPAN <freq>
CALCulate:SPECTrum:MARKer[1]|2|...|12:FUNCTion:BAND:SPAN?
CALCulate:SPECTrum:MARKer[1]|2|...|12:FUNCTion:RESult?
CALCulate:SPECTrum:MARKer[1]|2|...|12:MAXimum
CALCulate:SPECTrum:MARKer[1]|2|...|12:MAXimum:LEFT
CALCulate:SPECTrum:MARKer[1]|2|...|12:MAXimum:NEXT
CALCulate:SPECTrum:MARKer[1]|2|...|12:MAXimum:RIGHT
CALCulate:SPECTrum:MARKer[1]|2|...|12:MINimum
CALCulate:SPECTrum:MARKer[1]|2|...|12:MODE POSition | DELTA | OFF
CALCulate:SPECTrum:MARKer[1]|2|...|12:MODE?

```

3 Programming the Test Set

List of SCPI Commands

```
CALCulate:SPECTrum:MARKer:PEAK:EXCursion <rel_amp1>
CALCulate:SPECTrum:MARKer:PEAK:EXCursion?
CALCulate:SPECTrum:MARKer:PEAK:EXCursion:STATE OFF | ON | 0 | 1
CALCulate:SPECTrum:MARKer:PEAK:EXCursion:STATE?
CALCulate:SPECTrum:MARKer:PEAK:SEARCH:MODE MAXimum | PARAmeter
CALCulate:SPECTrum:MARKer:PEAK:SEARCH:MODE?
CALCulate:SPECTrum:MARKer:PEAK:THReshold <amp1>
CALCulate:SPECTrum:MARKer:PEAK:THReshold?
CALCulate:SPECTrum:MARKer:PEAK:THReshold:STATE OFF | ON | 0 | 1
CALCulate:SPECTrum:MARKer:PEAK:THReshold:STATE?
CALCulate:SPECTrum:MARKer[1]|2|...|12:PTPeak
CALCulate:SPECTrum:MARKer[1]|2|...|12:REFerence <integer>
CALCulate:SPECTrum:MARKer[1]|2|...|12:REFerence?
CALCulate:SPECTrum:MARKer[1]|2|...|12[:SET]:CENTER
CALCulate:SPECTrum:MARKer[1]|2|...|12[:SET]:RLEVEL
CALCulate:SPECTrum:MARKer[1]|2|...|12:STATE OFF | ON | 0 | 1
CALCulate:SPECTrum:MARKer[1]|2|...|12:STATE?
CALCulate:SPECTrum:MARKer[1]|2|...|12:TRACE SPECTrum | ASPECTrum | I | Q | IQ
CALCulate:SPECTrum:MARKer[1]|2|...|12:TRACE?
CALCulate:SPECTrum:MARKer[1]|2|...|12:X <freq>
CALCulate:SPECTrum:MARKer[1]|2|...|12:X?
CALCulate:SPECTrum:MARKer[1]|2|...|12:X:POSITION <freq>
CALCulate:SPECTrum:MARKer[1]|2|...|12:X:POSITION?
CALCulate:SPECTrum:MARKer[1]|2|...|12:Y?
CALCulate:WAVEform:MARKer:AOFF
CALCulate:WAVEform:MARKer:COUPLE[:STATE] ON | OFF | 1 | 0
CALCulate:WAVEform:MARKer:COUPLE[:STATE]?
CALCulate:WAVEform:MARKer[1]|2|...|12:FUNCTION BPOWER | BDENSITY | OFF
CALCulate:WAVEform:MARKer[1]|2|...|12:FUNCTION?
CALCulate:WAVEform:MARKer[1]|2|...|12:FUNCTION:BAND:LEFT <time>
CALCulate:WAVEform:MARKer[1]|2|...|12:FUNCTION:BAND:LEFT?
CALCulate:WAVEform:MARKer[1]|2|...|12:FUNCTION:BAND:RIGHT <time>
CALCulate:WAVEform:MARKer[1]|2|...|12:FUNCTION:BAND:RIGHT?
CALCulate:WAVEform:MARKer[1]|2|...|12:FUNCTION:BAND:SPAN <time>
CALCulate:WAVEform:MARKer[1]|2|...|12:FUNCTION:BAND:SPAN?
CALCulate:WAVEform:MARKer[1]|2|...|12:FUNCTION:RESULT?
CALCulate:WAVEform:MARKer[1]|2|...|12:MAXimum
CALCulate:WAVEform:MARKer[1]|2|...|12:MAXimum:NEXT
CALCulate:WAVEform:MARKer[1]|2|...|12:MINimum
CALCulate:WAVEform:MARKer[1]|2|...|12:MODE POSITION | DELTA | OFF
CALCulate:WAVEform:MARKer[1]|2|...|12:MODE?
CALCulate:WAVEform:MARKer[1]|2|...|12:REFerence <integer>
CALCulate:WAVEform:MARKer[1]|2|...|12:REFerence?
CALCulate:WAVEform:MARKer[1]|2|...|12:TRACE RFENvelope | I | Q | IQ
CALCulate:WAVEform:MARKer[1]|2|...|12:TRACE?
CALCulate:WAVEform:MARKer[1]|2|...|12:X <time>
CALCulate:WAVEform:MARKer[1]|2|...|12:X?
CALCulate:WAVEform:MARKer[1]|2|...|12:X:POSITION <real>
CALCulate:WAVEform:MARKer[1]|2|...|12:X:POSITION?
CALCulate:WAVEform:MARKer[1]|2|...|4:X:SPAN
CALCulate:WAVEform:MARKer[1]|2|...|12:Y?
CALibration[:ALL]
```

```

CALibration[:ALL]?
CALibration[:ALL]:NPENding
CALibration:EXPIred?
CALibration:IF
CALibration:IF?
CALibration:IF:NPENding
CALibration:INTernal:SOURce[:ALL]
CALibration:INTernal:SOURce[:ALL]?
CALibration:INTernal:SOURce[:ALL]:NPENding
CALibration:NRF
CALibration:NRF?
CALibration:NRF:NPENding
CALibration:RF
CALibration:RF?
CALibration:RF:NPENding
CALibration:TEMPerature:CURRent?
CALibration:TEMPerature:LALL?
CALibration:TEMPerature:LIF?
CALibration:TEMPerature:LRF?
CALibration:TIME:LALL?
CALibration:TIME:LIF?
CALibration:TIME:LRF?
CONF FSC
CONFigure?
CONFigure:SPECtrum
CONFigure:SPECtrum
CONFigure:SPECtrum:NDEFault
CONFigure:WAVEform
CONFigure:WAVEform
CONFigure:WAVEform:NDEFault
COUple ALL | NONE
DISPlay:<measurement>:ANNotation:TITLe:DATA <string>
DISPlay:<measurement>:ANNotation:TITLe:DATA?
DISPlay:ACTivefunc[:STATE] ON | OFF | 1 | 0
DISPlay:ACTivefunc[:STATE]?
DISPlay:ANNotation:MBAR[:STATE] OFF | ON | 0 | 1
DISPlay:ANNotation:MBAR[:STATE]?
DISPlay:ANNotation:SCREen[:STATE] OFF | ON | 0 | 1
DISPlay:ANNotation:SCREen[:STATE]?
DISPlay:SPECtrum:VIEW[1]:WINDow[1]|2:TRACe:Y[:SCALE]:COUple ON | OFF | 1 |
0
DISPlay:SPECtrum:VIEW[1]:WINDow[1]|2:TRACe:Y[:SCALE]:COUple?
DISPlay:SPECtrum:VIEW[1]:WINDow[1]:TRACe:Y[:SCALE]:PDIVision <rel_ampl>
DISPlay:SPECtrum:VIEW[1]:WINDow[1]:TRACe:Y[:SCALE]:PDIVision?
DISPlay:SPECtrum:VIEW[1]:WINDow[1]:TRACe:Y[:SCALE]:RLEVel <ampl>
DISPlay:SPECtrum:VIEW[1]:WINDow[1]:TRACe:Y[:SCALE]:RLEVel?
DISPlay:SPECtrum:VIEW[1]:WINDow[1]:TRACe:Y[:SCALE]:RPOsition TOP | CENTER
| BOTTOm
DISPlay:SPECtrum:VIEW[1]:WINDow[1]:TRACe:Y[:SCALE]:RPOsition?
DISPlay:WAVEform:VIEW:NSElect <integer>
DISPlay:WAVEform:VIEW:NSElect?
DISPlay:WAVEform:VIEW[:SElect] RFENvelope | IQ
DISPlay:WAVEform:VIEW[:SElect]?

```

3 Programming the Test Set

List of SCPI Commands

```
DISPlay:WAVEform:VIEW[1]|2:WINDow[1]:TRACe:X[:SCALe]:COUPlE 0 | 1 | OFF |
ON
DISPlay:WAVEform:VIEW[1]|2:WINDow[1]:TRACe:X[:SCALe]:COUPlE?
DISPlay:WAVEform:VIEW[1]|2:WINDow[1]:TRACe:X[:SCALe]:PDIVision <time>
DISPlay:WAVEform:VIEW[1]|2:WINDow[1]:TRACe:X[:SCALe]:PDIVision?
DISPlay:WAVEform:VIEW[1]|2:WINDow[1]:TRACe:X[:SCALe]:RLEVel <time>
DISPlay:WAVEform:VIEW[1]|2:WINDow[1]:TRACe:X[:SCALe]:RLEVel?
DISPlay:WAVEform:VIEW[1]|2:WINDow[1]:TRACe:X[:SCALe]:RPOSition LEFT |
CENTer | RIGHT
DISPlay:WAVEform:VIEW[1]|2:WINDow[1]:TRACe:X[:SCALe]:RPOSition?
DISPlay:WAVEform:VIEW[1]|2:WINDow[1]:TRACe:Y[:SCALe]:COUPlE 0 | 1 | OFF |
ON
DISPlay:WAVEform:VIEW[1]|2:WINDow[1]:TRACe:Y[:SCALe]:COUPlE?
DISPlay:WAVEform:VIEW[1]:WINDow[1]:TRACe:Y[:SCALe]:PDIVision <rel_ampl>
DISPlay:WAVEform:VIEW[1]:WINDow[1]:TRACe:Y[:SCALe]:PDIVision?
DISPlay:WAVEform:VIEW[1]:WINDow[1]:TRACe:Y[:SCALe]:RLEVel <ampl>
DISPlay:WAVEform:VIEW[1]:WINDow[1]:TRACe:Y[:SCALe]:RLEVel?
DISPlay:WAVEform:VIEW[1]:WINDow[1]:TRACe:Y[:SCALe]:RPOSition TOP | CENTer
| BOTTom
DISPlay:WAVEform:VIEW[1]:WINDow[1]:TRACe:Y[:SCALe]:RPOSition?
DISPlay:WINDow[1]:ANNOtation[:ALL] OFF | ON | 0 | 1
DISPlay:WINDow[1]:ANNOtation[:ALL]?
DISPlay:WINDow:FORMat:TILE
DISPlay:WINDow:FORMat:ZOOM
DISPlay:WINDow[:SElect] <number>
DISPlay:WINDow[:SElect]?
DISPlay:WINDow[1]:TRACe:GRATICule:GRID[:STATE] OFF | ON | 0 | 1
DISPlay:WINDow[1]:TRACe:GRATICule:GRID[:STATE]?
FEED:RF:PORT:OUTP RFIO1
FETCh:SPECTrum[n]?
FETCh:WAVEform[n]?
FORMat:BORDER NORMAL | SWAPPed
FORMat:BORDER?
FORMat[:TRACe][:DATA] ASCii | INTeger, 32 | REAL, 32 | REAL, 64
FORMat[:TRACe][:DATA]?
GLOBal:DEFault
GLOBal:FREQuency:CENTer[:STATE] 1 | 0 | ON | OFF
GLOBal:FREQuency:CENTer[:STATE]?
HCOpy:ABORT
HCOpy[:IMMediate]
INITiate:CONTinuous OFF | ON | 0 | 1
INITiate:CONTinuous?
INITiate[:IMMediate]
INITiate:PAUSE
INITiate:REStart
INITiate:RESume
INITiate:SPECTrum
INITiate:WAVEform
INPut<1|2>:TYPE INPUT1 | INPUT2
INPut<1|2>:TYPE?
INPut:MIXer EXTernal | INTernal
INPut:MIXer?
```



```

INST:NSEL 102
INST:NSEL 105
INSTrument:CATalog?
INSTrument:COUple:DEFault
INSTrument:COUple:FREQuency:CENTer ALL | NONE
INSTrument:COUple:FREQuency:CENTer?
INSTrument:DEFault
INSTrument:NSElect <integer>
INSTrument:NSElect?
INSTrument[:SElect] SA | RTSA | SEQAN | EMI | BASIC | WCDMA | EDGE | GSM |
WIMAXOFDMA | VSA | PNOISE | NFIGure | ADEMOD | BTooth | TDSCDMA | CDMA2K |
CDMA1XEV | LTE | LTETDD | LTEAFDD | LTEATDD | MSR | DVB | DTMB | DCTV |
ISDBT | CMMB | WLAN | CWLAN | CWIMAXOFDM | WIMAXFIXED | IDEN | RLC |
SCPILC | VSA89601
INSTrument[:SElect] RECeiver
INSTrument[:SElect] 'SA' | 'PNOISE' | 'EDGE' | 'GSM' | 'BASIC'
INSTrument[:SElect] GSM
INSTrument[:SElect] SANalyzer
INSTrument[:SElect]?
INST:SEL LTETDD
INST:SEL EMI
INST:SEL SCPILC
INST:SEL LTE
MEASure:SPECTrum[n]?
MEASure:WAVEform[n]?
MMEMory:CATalog? [<directory_name>]
MMEMory:CDIRectory [<directory_name>]
MMEMory:CDIRectory?
MMEMory:COpy <string>, <string>[, <string>, <string>]
MMEMory:COpy:DEvIce <source_string>, <dest_string>
MMEMory:DATA <file_name>, <data>
MMEMory:DATA? <file_name>
MMEMory:DELEte <file_name>[, <directory_name>]
MMEMory:HEADer:ID? "<filename>"
MMEMory:LOAD:CORRection ANTenna | CABLE | OTHer | USER, <filename>
MMEMory:LOAD:CORRection 1 | 2 | 3 | 4 | 5 | 6 | 7 | 8, <filename>
MMEMory:LOAD:SEQuences:| SLIST | ALIST | SAAList | "MySequence.txt"
MMEMory:LOAD:STATe 1, <filename>
MMEMory:LOAD:STATe <filename>
MMEMory:MDIRectory <directory_name>
MMEMory:MOVE <string>, <string>[, <string>, <string>]
MMEMory:RDIRectory <directory_name>
MMEMory:REGister:STATe:LAbel <regnumber>, "label"
MMEMory:REGister:STATe:LAbel? <regnumber>
MMEMory:STORE:CORRection 1 | 2 | 3 | 4 | 5 | 6, <filename>
MMEMory:STORE:CORRection ANTenna | CABLE | OTHer | USER, <filename>
MMEMory:STORE:RESults:MTABLE|PTABLE|SPECTrogram <filename>
MMEMory:STORE:SCReen <filename>
MMEMory:STORE:SCReen:THEME TDColor | TDMonochrome | FCOLOR | FMONochrome
MMEMory:STORE:SCReen:THEME?
MMEMory:STORE:STATe <filename>
MMEMory:STORE:STATe 1, <filename>

```

3 Programming the Test Set
List of SCPI Commands

```

MMEM:STOR:SEquences:| SLIST | ALIST | SAALIST | SSTEP"MySequence.txt"
OUTPut:ANALog OFF | SVIDeo | LOGVideo | LINVideo | DAUDio
OUTPut:ANALog?
OUTPut:ANALog:AUTO OFF | ON | 0 | 1
OUTPut:ANALog:AUTO?
OUTPut[:EXtErnal][:STATe] ON | OFF | 1 | 0
OUTPut[:EXtErnal][:STATe]?
OUTPut:MODulation[:STATe] ON | OFF | 1 | 0
OUTPut:MODulation[:STATe]?
READ:SPECTrum[n]?
READ:WAVEform[n]?
[:SENSe]:<measurement>:TRIGger:SOURce IF
[:SENSe]:<measurement>:TRIGger:SOURce
[:SENSe]:ACPR:TRIGger:SOURce
[:SENSe]:CORRection:BTS[:RF]:GAIN <rel_ampl>
[:SENSe]:CORRection:BTS[:RF]:GAIN?
[:SENSe]:CORRection:BTS[:RF]:LOSS <rel_ampl>
[:SENSe]:CORRection:BTS[:RF]:LOSS?
[:SENSe]:CORRection:CSET:ALL:DELeTe
[:SENSe]:CORRection:CSET:ALL[:STATe] ON | OFF | 1 | 0
[:SENSe]:CORRection:CSET:ALL[:STATe]?
[:SENSe]:CORRection:CSET[1]:ANTenna[:UNIT] GAUSs | PTESla | UVM | UAM | UA
| NOConversion
[:SENSe]:CORRection:CSET[1]:ANTenna[:UNIT]?
[:SENSe]:CORRection:CSET[1]|2|...|8:COMMeNt "text"
[:SENSe]:CORRection:CSET[1]|2|...|8:COMMeNt?
[:SENSe]:CORRection:CSET[1]|2|...|8:DATA <freq>, <ampl>, ...
[:SENSe]:CORRection:CSET[1]|2|...|8:DATA?
[:SENSe]:CORRection:CSET[1]|2|...|8:DATA:MERGe <freq>, <ampl>, ...
[:SENSe]:CORRection:CSET[1]|2|...|6:DELeTe
[:SENSe]:CORRection:CSET[1]|2|...|8:DESCription "text"
[:SENSe]:CORRection:CSET[1]|2|...|8:DESCription?
[:SENSe]:CORRection:CSET[1]|2|...|8:RF:PORT RFIN | RFIO1 | RFIO2 | RFOut |
GPSout | GNSSout | RFIO3 | RFIO4
[:SENSe]:CORRection:CSET[1]|2|...|8:RF:PORT?
[:SENSe]:CORRection:CSET[1]|2|...|8:RF:PORT:RFIO2 SOURce | ANALyzer | BOTH
[:SENSe]:CORRection:CSET[1]|2|...|8:RF:PORT:RFIO1 SOURce | ANALyzer | BOTH
[:SENSe]:CORRection:CSET[1]|2|...|8:RF:PORT:RFIO1?
[:SENSe]:CORRection:CSET[1]|2|...|8:RF:PORT:RFIO2?
[:SENSe]:CORRection:CSET[1]|2|...|8[:STATe] ON | OFF | 1 | 0
[:SENSe]:CORRection:CSET[1]|2|...|8[:STATe]?
[:SENSe]:CORRection:CSET[1]|2|...|8:X:SPACing LINear | LOGarithmic
[:SENSe]:CORRection:CSET[1]|2|...|8:X:SPACing?
[:SENSe]:CORRection:IMPedance[:INPut][:MAGNitude] 50 | 75
[:SENSe]:CORRection:IMPedance[:INPut][:MAGNitude]?
[:SENSe]:CORRection:MS[:RF]:GAIN <rel_ampl>
[:SENSe]:CORRection:MS[:RF]:GAIN?
[:SENSe]:CORRection:MS[:RF]:LOSS <rel_ampl>
[:SENSe]:CORRection:MS[:RF]:LOSS?
[:SENSe]:CORRection:OFFSet[:MAGNitude]
[:SENSe]:CORRection:SA[:RF]:GAIN <rel_ampl>
[:SENSe]:CORRection:SA[:RF]:GAIN?
[:SENSe]:FEED IQ | IONLy | QONLy

```

```

[:SENSe]:FEED AREFERENCE
[:SENSe]:FEED RF | AIQ | EMIXer
[:SENSe]:FEED?
[:SENSe]:FEED?
[:SENSe]:FEED:RF:PORT[:INPut] RFIN | RFIN2 | RFIO1 | RFIO2 | RFIO3 | RFIO4
[:SENSe]:FEED:RF:PORT[:INPut]?
[:SENSe]:FEED:RF:PORT:OUTPut RFOut | RFIO1 | RFIO2 | GPSout | GNSSout |
RFIO3 | RFIO4
[:SENSe]:FEED:RF:PORT:OUTPut?
[:SENSe]:FREQuency:CENTer <freq>
[:SENSe]:FREQuency:CENTer?
[:SENSe]:FREQuency:EMIXer:CENTer <freq>
[:SENSe]:FREQuency:EMIXer:CENTer?
[:SENSe]:FREQuency:IQ:CENTer <freq>
[:SENSe]:FREQuency:IQ:CENTer?
[:SENSe]:FREQuency:RF:CENTer <freq>
[:SENSe]:FREQuency:RF:CENTer?
[:SENSe]:HDUPlex:PORT:INPut RFIO3 | RFIO4
[:SENSe]:HDUPlex:PORT:OUTPut RFIO3 | RFIO4
[:SENSe]:POWer[:RF]:RANGe <real>
[:SENSe]:POWer[:RF]:RANGe?
[:SENSe]:POWer[:RF]:RANGe:MIXer:OFFSet <real>
[:SENSe]:POWer[:RF]:RANGe:MIXer:OFFSet?
[:SENSe]:POWer[:RF]:RANGe:PARatio <real>
[:SENSe]:POWer[:RF]:RANGe:PARatio?
[:SENSe]:ROSCillator:EXTernal:FREQuency <freq>
[:SENSe]:ROSCillator:EXTernal:FREQuency?
[:SENSe]:ROSCillator:SOURce INTernal | EXTernal
[:SENSe]:ROSCillator:SOURce?
[:SENSe]:ROSCillator:SOURce:TYPE INTernal | EXTernal | SENSE | PULSE
[:SENSe]:ROSCillator:SOURce:TYPE?
[:SENSe]:SPECTrum:AVERage:COUNT <integer>
[:SENSe]:SPECTrum:AVERage:COUNT?
[:SENSe]:SPECTrum:AVERage[:STATE] ON | OFF | 1 | 0
[:SENSe]:SPECTrum:AVERage[:STATE]?
[:SENSe]:SPECTrum:AVERage:TCONtrol EXPonential | REPEAT
[:SENSe]:SPECTrum:AVERage:TCONtrol?
[:SENSe]:SPECTrum:AVERage:TYPE RMS | LOG | SCALar
[:SENSe]:SPECTrum:AVERage:TYPE?
[:SENSe]:SPECTrum:BANDwidth|BWIDth:IF:SHAPE
[:SENSe]:SPECTrum:BANDwidth|BWIDth:IF[:SIZE]
[:SENSe]:SPECTrum:BANDwidth:PFfT[:SIZE]
[:SENSe]:SPECTrum:BANDwidth:PFfT:TYPE
[:SENSe]:SPECTrum:BANDwidth[:RESolution] <bandwidth>
[:SENSe]:SPECTrum:BANDwidth[:RESolution]?
[:SENSe]:SPECTrum:BANDwidth[:RESolution]:AUTO ON | OFF | 1 | 0
[:SENSe]:SPECTrum:BANDwidth[:RESolution]:AUTO?
[:SENSe]:SPECTrum:BWIDth:PFfT[:SIZE]
[:SENSe]:SPECTrum:BWIDth:PFfT:TYPE
[:SENSe]:SPECTrum:BWIDth[:RESolution]
[:SENSe]:SPECTrum:DIF:BANDwidth <freq>
[:SENSe]:SPECTrum:DIF:BANDwidth?
[:SENSe]:SPECTrum:DIF:BANDwidth:AUTO ON | OFF | 1 | 0

```

3 Programming the Test Set

List of SCPI Commands

```
[ :SENSe ]:SPECtrum:DIF:BANDwidth:AUTO?
[ :SENSe ]:SPECtrum:DIF:FILTer:ALPHa <real>
[ :SENSe ]:SPECtrum:DIF:FILTer:ALPHa?
[ :SENSe ]:SPECtrum:DIF:FILTer:BANDwidth <freq>
[ :SENSe ]:SPECtrum:DIF:FILTer:BANDwidth?
[ :SENSe ]:SPECtrum:DIF:FILTer:BANDwidth:AUTO ON | OFF | 1 | 0
[ :SENSe ]:SPECtrum:DIF:FILTer:BANDwidth:AUTO?
[ :SENSe ]:SPECtrum:DIF:FILTer:TYPE
[ :SENSe ]:SPECtrum:DIF:FILTer:TYPE?
[ :SENSe ]:SPECtrum:FFT:LENGth <integer>
[ :SENSe ]:SPECtrum:FFT:LENGth?
[ :SENSe ]:SPECtrum:FFT:LENGth:AUTO ON | OFF | 1 | 0
[ :SENSe ]:SPECtrum:FFT:LENGth:AUTO?
[ :SENSe ]:SPECtrum:FFT:RBWPoints <real>
[ :SENSe ]:SPECtrum:FFT:RBWPoints?
[ :SENSe ]:SPECtrum:FFT:WINDow:LENGth <integer>
[ :SENSe ]:SPECtrum:FFT:WINDow:LENGth?
[ :SENSe ]:SPECtrum:FFT:WINDow[:TYPE] FLATtop | UNIFORM | HANNing | HAMMING
| GAUSSian | BLACKman | BH4Tap | KB70 | KB90 | KB110
[ :SENSe ]:SPECtrum:FFT:WINDow[:TYPE]?
[ :SENSe ]:SPECtrum:FREQuency:SPAN <freq>
[ :SENSe ]:SPECtrum:FREQuency:SPAN?
[ :SENSe ]:SPECtrum:SRATE?
[ :SENSe ]:SPECtrum:WBIF:FILTer:ALPHa
[ :SENSe ]:WAVEform:APERture?
[ :SENSe ]:WAVEform:AVERage:COUNt <integer>
[ :SENSe ]:WAVEform:AVERage:COUNt?
[ :SENSe ]:WAVEform:AVERage[:STATE] OFF | ON | 0 | 1
[ :SENSe ]:WAVEform:AVERage[:STATE]?
[ :SENSe ]:WAVEform:AVERage:TCONtrol EXPonential | REPeat
[ :SENSe ]:WAVEform:AVERage:TCONtrol?
[ :SENSe ]:WAVEform:AVERage:TYPE LOG | RMS | SCALar
[ :SENSe ]:WAVEform:AVERage:TYPE?
[ :SENSe ]:WAVEform:AVERage:TYPE:AUTO[:STATE] ON | OFF | 1 | 0
[ :SENSe ]:WAVEform:AVERage:TYPE:AUTO[:STATE]?
[ :SENSe ]:WAVEform:BANDwidth|BWIDth[:RESolution]:TYPE
[ :SENSe ]:WAVEform:BANDwidth[:RESolution]
[ :SENSe ]:WAVEform:BANDwidth:SHAPE
[ :SENSe ]:WAVEform:BWIDth[:RESolution]
[ :SENSe ]:WAVEform:BWIDth:SHAPE
[ :SENSe ]:WAVEform:DIF:BANDwidth <freq>
[ :SENSe ]:WAVEform:DIF:BANDwidth?
[ :SENSe ]:WAVEform:DIF:FILTer:ALPHa <real>
[ :SENSe ]:WAVEform:DIF:FILTer:ALPHa?
[ :SENSe ]:WAVEform:DIF:FILTer:BANDwidth <freq>
[ :SENSe ]:WAVEform:DIF:FILTer:BANDwidth?
[ :SENSe ]:WAVEform:DIF:FILTer:BANDwidth:AUTO ON | OFF | 1 | 0
[ :SENSe ]:WAVEform:DIF:FILTer:BANDwidth:AUTO?
[ :SENSe ]:WAVEform:DIF:FILTer:TYPE GAUSSian | FLATtop
[ :SENSe ]:WAVEform:DIF:FILTer:TYPE GAUSSian | FLATtop | SNYquist |
RSNYquist | RCOSine | RRCosine
[ :SENSe ]:WAVEform:DIF:FILTer:TYPE?
[ :SENSe ]:WAVEform:DIF:FILTer:TYPE?
```

```

[:SENSe]:WAVeform:SRATe <freq>
[:SENSe]:WAVeform:SRATe?
[:SENSe]:WAVeform:SWEep:TIME <time>
[:SENSe]:WAVeform:SWEep:TIME?
[:SENSe]:WAVeform:WBIF:FILTer:ALPHa
SOURce:AM[:DEPTh][:LINear]
SOURce:AM[:DEPTh][:LINear]?
SOURce:AM:INTernal:FREQuency
SOURce:AM:INTernal:FREQuency?
SOURce:AM:STATe
SOURce:AM:STATe?
SOURce:FM[:DEVIation]
SOURce:FM[:DEVIation]?
SOURce:FM:INTernal:FREQuency
SOURce:FM:INTernal:FREQuency?
SOURce:FM:STATe
SOURce:FM:STATe?
SOURce:FREQuency:CHANnels:BAND NONE | PGSM | EGSM | RGSM | DCS1800 |
PCS1900 | TGSM810 | GSM450 | GSM480 | GSM700 | GSM850 | BANDI | BANDII |
BANDIII | BANDIV | BANDV | BANDVI | BANDVII | BANDVIII | BANDIX | BANDX |
BANDXI | BANDXII | BANDXIII | BANDXIV | BANDXIX | USCELL | USPCS | JAPAN |
KOREAN | NMT | IMT2K | UPPER | SECOND | PAMR400 | PAMR800 | IMTEXT |
PCS1DOT9G | AWS | US2DOT5G | PUBLIC | LOWER | BAND1 | BAND2 | BAND3 |
BAND4 | BAND5 | BAND6 | BAND7 | BAND8 | BAND10 | BAND11 | BAND12 | BAND13
| BAND14 | BAND17 | BAND18 | BAND19 | BAND20 | BAND21 | BAND24 | BAND25 |
BAND26 | BAND27 | BAND28 | BAND29 | BAND30 | BAND31 | BAND33 | BAND34 |
BAND35 | BAND36 | BAND37 | BAND38 | BAND39 | BAND40 | BAND41 | BAND42 |
BAND43 | BAND44 | BANDA | BANDB | BANDC | BANDD | BANDE | BANDE
SOURce:FREQuency:CHANnels:BAND?
SOURce:FREQuency:CHANnels:NUMBer <int>
SOURce:FREQuency:CHANnels:NUMBer?
SOURce:FREQuency[:CW] <freq>
SOURce:FREQuency[:CW]?
SOURce:FREQuency:OFFSet <freq>
SOURce:FREQuency:OFFSet?
SOURce:FREQuency:REFerence <freq>
SOURce:FREQuency:REFerence?
SOURce:FREQuency:REFerence:SET
SOURce:FREQuency:REFerence:STATe OFF | ON | 0 | 1
SOURce:FREQuency:REFerence:STATe?
SOURce:LIST:INITiation:ARMed?
SOURce:LIST:NUMBer:STEPs <integer>
SOURce:LIST:NUMBer:STEPs?
SOURce:LIST:SETup:AMPLitude <ampl>, <ampl>, <ampl>, ...
SOURce:LIST:SETup:AMPLitude?
SOURce:LIST:SETup:CLEar
SOURce:LIST:SETup:CNFRequency <double>, <double>, <double>, ...
SOURce:LIST:SETup:CNFRequency?
SOURce:LIST:SETup:DURation:TYPE <enum>, <enum>, <enum>, ...
SOURce:LIST:SETup:DURation:TYPE?
SOURce:LIST:SETup:INPut:TRIGger <enum>, <enum>, <enum>, ...
SOURce:LIST:SETup:INPut:TRIGger?

```

3 Programming the Test Set

List of SCPI Commands

```
SOURce:LIST:SETup:OUTPut:TRIGger ?
SOURce:LIST:SETup:OUTPut:TRIGger <bool>, <bool>, <bool>, ...
SOURce:LIST:SETup:RADio:BAND <enum>, <enum>, <enum>, ...
SOURce:LIST:SETup:RADio:BAND?
SOURce:LIST:SETup:RADio:BAND:LINK <enum>, <enum>, <enum>, ...
SOURce:LIST:SETup:RADio:BAND:LINK?
SOURce:LIST:SETup:TOCount <time/int>, <time/int>, <time/int>, ...
SOURce:LIST:SETup:TOCount?
SOURce:LIST:SETup:TRANSition:TIME <time>, <time>, <time>, ...
SOURce:LIST:SETup:TRANSition:TIME?
SOURce:LIST:SETup:WAVEform <string>, <string>, <string>, ...
SOURce:LIST:SETup:WAVEform?
SOURce:LIST[:STATE] ON | OFF | 1 | 0
SOURce:LIST[:STATE]?
SOURce:LIST:STEP[1]|2|...|4..1000:SETup IMMEDIATE | INTernal | KEY | BUS |
EXTernal2, <time>, NONE | PGSM | EGSM | RGSM | DCS1800 | PCS1900 | TGSM810
| GSM450 | GSM480 | GSM700 | GSM850 | BANDI | BANDII | BANDIII | BANDIV |
BANDV | BANDVI | BANDVII | BANDVIII | BANDIX | BANDX | BANDXI | BANDXII |
BANDXIII | BANDXIV | BANDXIX | USCELL | USPCS | JAPAN | KOREAN | NMT |
IMT2K | UPPER | SECOND | PAMR400 | PAMR800 | IMTEXT | PCS1DOT9G | AWS |
US2DOT5G | PUBLIC | LOWER | NONE | BAND1 | BAND2 | BAND3 | BAND4 | BAND5 |
BAND6 | BAND7 | BAND8 | BAND10 | BAND11 | BAND12 | BAND13 | BAND14 |
BAND17 | BAND18 | BAND19 | BAND20 | BAND21 | BAND24 | BAND25 | BAND26 |
BAND33 | BAND34 | BAND35 | BAND36 | BAND37 | BAND38 | BAND39 | BAND40 |
BAND41 | BAND42 | BAND43 | BANDA | BANDB | BANDC | BANDD | BANDE | BANDF,
DOWN | UP, <freq>, <ampl>, <string>, TIME | COUNT | CONTinuous, <time>, ON
| OFF | 1 | 0, [<int>],
SOURce:LIST:STEP[1]|2|...|4..1000:SETup?
SOURce:LIST:STEP[1]|2|3...1000:SETup:AMPLitude <double>
SOURce:LIST:STEP[1]|2|3...1000:SETup:AMPLitude?
SOURce:LIST:STEP[1]|2|3...1000:SETup:CNFRequency <double>
SOURce:LIST:STEP[1]|2|3...1000:SETup:CNFRequency <double>
SOURce:LIST:STEP[1]|2|3...1000:SETup:CNFRequency?
SOURce:LIST:STEP[1]|2|3...1000:SETup:CNFRequency?
SOURce:LIST:STEP[1]|2|3...1000:SETup:DURation:TCOUNT <double>
SOURce:LIST:STEP[1]|2|3...1000:SETup:DURation:TCOUNT?
SOURce:LIST:STEP[1]|2|3...1000:SETup:DURation:TYPE TIME | COUNT |
CONTinuous | CABort
SOURce:LIST:STEP[1]|2|3...1000:SETup:DURation:TYPE?
SOURce:LIST:STEP[1]|2|3...1000:SETup:INPut:TRIGger IMMEDIATE | INTernal |
EXTernal2 | KEY | BUS | EXTernal4
SOURce:LIST:STEP[1]|2|3...1000:SETup:INPut:TRIGger?
SOURce:LIST:STEP[1]|2|3...1000:SETup:OUTPut:TRIGger
SOURce:LIST:STEP[1]|2|3...1000:SETup:OUTPut:TRIGger ON | OFF | 1 | 0
SOURce:LIST:STEP[1]|2|3...1000:SETup:RADio:BAND NONE | PGSM | EGSM | RGSM
| DCS1800 | PCS1900 | TGSM810 | GSM450 | GSM480 | GSM700 | GSM850 | BANDI
| BANDII | BANDIII | BANDIV | BANDV | BANDVI | BANDVII | BANDVIII | BANDIX
| BANDX | BANDXI | BANDXII | BANDXIII | BANDXIV | BANDXIX | USCELL | USPCS
| JAPAN | KOREAN | NMT | IMT2K | UPPER | SECOND | PAMR400 | PAMR800 |
IMTEXT | PCS1DOT9G | AWS | US2DOT5G | PUBLIC | LOWER | NONE | BAND1 |
BAND2 | BAND3 | BAND4 | BAND5 | BAND6 | BAND7 | BAND8 | BAND10 | BAND11 |
```

```

BAND12 | BAND13 | BAND14 | BAND17 | BAND18 | BAND19 | BAND20 | BAND21 |
BAND24 | BAND25 | BAND26 | BAND27 | BAND28 | BAND29 | BAND30 | BAND31 |
BAND33 | BAND34 | BAND35 | BAND36 | BAND37 | BAND38 | BAND39 | BAND40 |
BAND41 | BAND42 | BAND43 | BAND44 | BANDA | BANDB | BANDC | BANDD | BANDE
| BANDF
SOURCE:LIST:STEP[1]|2|3...1000:SETup:RADio:BAND?
SOURCE:LIST:STEP[1]|2|3...1000:SETup:RADio:BAND:LINK DOWN | UP
SOURCE:LIST:STEP[1]|2|3...1000:SETup:RADio:BAND:LINK?
SOURCE:LIST:STEP[1]|2|3...1000:SETup:TRANSition:TIME <time>
SOURCE:LIST:STEP[1]|2|3...1000:SETup:TRANSition:TIME?
SOURCE:LIST:STEP[1]|2|3...1000:SETup:WAVEform <string>
SOURCE:LIST:STEP[1]|2|3...1000:SETup:WAVEform?
SOURCE:LIST:TRIGger[:IMMediate]
SOURCE:LIST:TRIGger:INITiate[:IMMediate]
SOURCE:LIST:TRIGgerout:TYPe BEGinningofstep | DATAmarker
SOURCE:PM[:DEVIation]
SOURCE:PM[:DEVIation]?
SOURCE:PM:INTernal:FREQuency
SOURCE:PM:INTernal:FREQuency?
SOURCE:PM:STATE
SOURCE:PM:STATE?
SOURCE:POWER[:LEVel][:IMMediate][:AMPLitude] <ampl>
SOURCE:POWER[:LEVel][:IMMediate][:AMPLitude]?
SOURCE:POWER[:LEVel][:IMMediate]:OFFSet <rel_ampl>
SOURCE:POWER[:LEVel][:IMMediate]:OFFSet?
SOURCE:POWER:REFerence <ampl>
SOURCE:POWER:REFerence?
SOURCE:POWER:REFerence:STATE OFF | ON | 0 | 1
SOURCE:POWER:REFerence:STATE?
SOURCE:PRESet
SOURCE:RADio:ARB:BASEband:FREQuency:OFFSet <freq>
SOURCE:RADio:ARB:BASEband:FREQuency:OFFSet?
SOURCE:RADio:ARB:CATalog?
SOURCE:RADio:ARB:DEFault:DIRectory <string>
SOURCE:RADio:ARB:DEFault:DIRectory?
SOURCE:RADio:ARB:DELeTe <string>
SOURCE:RADio:ARB:DELeTe:ALL
SOURCE:RADio:ARB:FCATalog?
SOURCE:RADio:ARB:HEADer:CLEar
SOURCE:RADio:ARB:HEADer:SAVE
SOURCE:RADio:ARB:LOAD <string>
SOURCE:RADio:ARB:LOAD:ALL <string>
SOURCE:RADio:ARB:MDEStination:ALCHold NONE | M1 | M2 | M3 | M4
SOURCE:RADio:ARB:MDEStination:ALCHold?
SOURCE:RADio:ARB:MDEStination:PULSe NONE | M1 | M2 | M3 | M4
SOURCE:RADio:ARB:MDEStination:PULSe?
SOURCE:RADio:ARB:MPLicensed:NAME:LOCKed?
SOURCE:RADio:ARB:MPLicensed:UID:LOCKed?
SOURCE:RADio:ARB:MPOLarity:MARKer4 POSitive | NEGative
SOURCE:RADio:ARB:MPOLarity:MARKer3 POSitive | NEGative
SOURCE:RADio:ARB:MPOLarity:MARKer1 POSitive | NEGative
SOURCE:RADio:ARB:MPOLarity:MARKer2 POSitive | NEGative

```

3 Programming the Test Set

List of SCPI Commands

```
SOURce:RADio:ARB:MPOLarity:MARKer4?
SOURce:RADio:ARB:MPOLarity:MARKer3?
SOURce:RADio:ARB:MPOLarity:MARKer2?
SOURce:RADio:ARB:MPOLarity:MARKer1?
SOURce:RADio:ARB:NOISe:BANDwidth <freq>
SOURce:RADio:ARB:NOISe:BANDwidth?
SOURce:RADio:ARB:NOISe:CBWidth <freq>
SOURce:RADio:ARB:NOISe:CBWidth?
SOURce:RADio:ARB:NOISe:CN <ampl>
SOURce:RADio:ARB:NOISe:CN?
SOURce:RADio:ARB:NOISe:POWer:CONTRol[:MODE] TOTal | CARRier | NOISe |
NCHannel
SOURce:RADio:ARB:NOISe:POWer:CONTRol[:MODE]?
SOURce:RADio:ARB:NOISe[:STATe] ON | OFF | 1 | 0
SOURce:RADio:ARB:NOISe[:STATe]?
SOURce:RADio:ARB:RETRigger ON | OFF | IMMEDIATE
SOURce:RADio:ARB:RETRigger?
SOURce:RADio:ARB:RMS <float>
SOURce:RADio:ARB:RMS?
SOURce:RADio:ARB:RMS:CALCulate
SOURce:RADio:ARB:RMS:CALCulation:MODE AUTO | M1 | M2 | M3 | M4
SOURce:RADio:ARB:RMS:CALCulation:MODE?
SOURce:RADio:ARB:RSCaling <real>
SOURce:RADio:ARB:RSCaling?
SOURce:RADio:ARB:SCLock:RATE <freq>
SOURce:RADio:ARB:SCLock:RATE?
SOURce:RADio:ARB:SEQuence[:MWAVeform] <filename>, <waveform1>, <reps>,
NONE | M1 | M2 | M3 | M4 | M1M2 | M1M3 | M1M4 | M2M3 | M2M4 | M3M4 |
M1M2M3 | M1M2M4 | M1M3M4 | M2M3M4 | M1M2M3M4 | ALL, {<waveform2>, <reps>,
NONE | M1 | M2 | M3 | M4 | M1M2 | M1M3 | M1M4 | M2M3 | M2M4 | M3M4 |
M1M2M3 | M1M2M4 | M1M3M4 | M2M3M4 | M1M2M3M4 | ALL, }...
SOURce:RADio:ARB:SEQuence[:MWAVeform]? <filename>
SOURce:RADio:ARB[:STATe] ON | OFF | 1 | 0
SOURce:RADio:ARB[:STATe]?
SOURce:RADio:ARB:TRIGger:INITiate
SOURce:RADio:ARB:TRIGger[:SOURce] KEY | BUS | EXTERNAL2
SOURce:RADio:ARB:TRIGger[:SOURce]?
SOURce:RADio:ARB:TRIGger:TYPE CONTinuous | SINGle | SADVance
SOURce:RADio:ARB:TRIGger:TYPE?
SOURce:RADio:ARB:TRIGger:TYPE:CONTinuous[:TYPE] FREE | TRIGger | RESet
SOURce:RADio:ARB:TRIGger:TYPE:CONTinuous[:TYPE]?
SOURce:RADio:ARB:TRIGger:TYPE:SADVance[:TYPE] SINGle | CONTinuous
SOURce:RADio:ARB:TRIGger:TYPE:SADVance[:TYPE]?
SOURce:RADio:ARB:WAVeform <string>
SOURce:RADio:ARB:WAVeform?
SOURce:RADio:BAND:LINK DOWN | UP
SOURce:RADio:BAND:LINK?
SOURce:RADio:DEVIce BTS | MS
SOURce:RADio:DEVIce?
STATus:OPERation:CONDition?
STATus:OPERation:ENABle <integer>
STATus:OPERation:ENABle?
```



```

STATUS:OPERation[:EVENT]?
STATUS:OPERation:NTRansition <integer>
STATUS:OPERation:NTRansition?
STATUS:OPERation:PTRansition <integer>
STATUS:OPERation:PTRansition?
STATUS:PRESet
STATUS:QUESTionable:CALibration:CONDition?
STATUS:QUESTionable:CALibration:ENABle <integer>
STATUS:QUESTionable:CALibration:ENABle?
STATUS:QUESTionable:CALibration[:EVENT]?
STATUS:QUESTionable:CALibration:NTRansition <integer>
STATUS:QUESTionable:CALibration:NTRansition?
STATUS:QUESTionable:CALibration:PTRansition <integer>
STATUS:QUESTionable:CALibration:PTRansition?
STATUS:QUESTionable:CONDition?
STATUS:QUESTionable:ENABle <integer>
STATUS:QUESTionable:ENABle?
STATUS:QUESTionable[:EVENT]?
STATUS:QUESTionable:FREQuency:CONDition?
STATUS:QUESTionable:FREQuency:ENABle <integer>
STATUS:QUESTionable:FREQuency:ENABle?
STATUS:QUESTionable:FREQuency[:EVENT]?
STATUS:QUESTionable:FREQuency:NTRansition <integer>
STATUS:QUESTionable:FREQuency:NTRansition?
STATUS:QUESTionable:FREQuency:PTRansition <integer>
STATUS:QUESTionable:FREQuency:PTRansition?
STATUS:QUESTionable:INTEgrity:CONDition?
STATUS:QUESTionable:INTEgrity:ENABle <integer>
STATUS:QUESTionable:INTEgrity:ENABle?
STATUS:QUESTionable:INTEgrity[:EVENT]?
STATUS:QUESTionable:INTEgrity:NTRansition <integer>
STATUS:QUESTionable:INTEgrity:NTRansition?
STATUS:QUESTionable:INTEgrity:PTRansition <integer>
STATUS:QUESTionable:INTEgrity:PTRansition?
STATUS:QUESTionable:NTRansition <integer>
STATUS:QUESTionable:NTRansition?
STATUS:QUESTionable:POWER:CONDition?
STATUS:QUESTionable:POWER:ENABle <integer>
STATUS:QUESTionable:POWER:ENABle?
STATUS:QUESTionable:POWER[:EVENT]?
STATUS:QUESTionable:POWER:NTRansition <integer>
STATUS:QUESTionable:POWER:NTRansition?
STATUS:QUESTionable:POWER:PTRansition <integer>
STATUS:QUESTionable:POWER:PTRansition?>
STATUS:QUESTionable:PTRansition <integer>
STATUS:QUESTionable:PTRansition?
STATUS:QUESTionable:TEMPerature:CONDition?
STATUS:QUESTionable:TEMPerature:ENABle <integer>
STATUS:QUESTionable:TEMPerature:ENABle?
STATUS:QUESTionable:TEMPerature[:EVENT]?
STATUS:QUESTionable:TEMPerature:NTRansition <integer>
STATUS:QUESTionable:TEMPerature:NTRansition?
STATUS:QUESTionable:TEMPerature:PTRansition <integer>

```

3 Programming the Test Set

List of SCPI Commands

```
STaTus:QUEStionable:TEMPerature:PTRansition?
SYSTem:APPLication:CATalog[:NAME]?
SYSTem:APPLication:CATalog[:NAME]:COUNT?
SYSTem:APPLication:CATalog:OPTion? <model>
SYSTem:APPLication:CATalog:REVision? <model>
SYSTem:APPLication[:CURRent][:NAME]?
SYSTem:APPLication[:CURRent]:OPTion?
SYSTem:APPLication[:CURRent]:REVision?
SYSTem:COMMunicate:LAN:SCPI:HISLip:ENABle OFF | ON | 0 | 1
SYSTem:COMMunicate:LAN:SCPI:HISLip:ENABle?
SYSTem:COMMunicate:LAN:SCPI:SICL:ENABle OFF | ON | 0 | 1
SYSTem:COMMunicate:LAN:SCPI:SICL:ENABle?
SYSTem:COMMunicate:LAN:SCPI:SOCKet:CONTRol?
SYSTem:COMMunicate:LAN:SCPI:SOCKet:ENABle OFF | ON | 0 | 1
SYSTem:COMMunicate:LAN:SCPI:SOCKet:ENABle?
SYSTem:COMMunicate:LAN:SCPI:TELNet:ENABle OFF | ON | 0 | 1
SYSTem:COMMunicate:LAN:SCPI:TELNet:ENABle?
SYSTem:CONFigure[:SYSTem]?
SYSTem:CSYSTem?
SYSTem:DATE "<year>, <month>, <day>"
SYSTem:DATE?
SYSTem:DEFault [ALL] | ALIGn | INPut | MISC | MODes | PON
SYSTem:ERRor[:NEXT]?
SYSTem:ERRor:OVERload[:STATE] 0 | 1 | OFF | ON
SYSTem:ERRor:PUP?
SYSTem:ERRor:VERBose OFF | ON | 0 | 1
SYSTem:ERRor:VERBose?
SYSTem:HELP:HEADers?
SYSTem:HID?
SYSTem:KLOCK OFF | ON | 0 | 1
SYSTem:KLOCK?
SYSTem:LICense[:FPACK]:WAVEform:ADD <string>
SYSTem:LICense[:FPACK]:WAVEform:CLEar <int>
SYSTem:LICense[:FPACK]:WAVEform:FREE?
SYSTem:LICense[:FPACK]:WAVEform:LOCK <int>
SYSTem:LICense[:FPACK]:WAVEform:NAME? <int>
SYSTem:LICense[:FPACK]:WAVEform:REPLace <int>, <string>
SYSTem:LICense[:FPACK]:WAVEform:STaTus? <int>
SYSTem:LICense[:FPACK]:WAVEform:UID? <int>
SYSTem:LICense[:FPACK]:WAVEform:USED?
SYSTem:LKEY <"OptionInfo">, <"LicenseInfo">
SYSTem:LKEY? <"OptionInfo">
SYSTem:LKEY:DELeTe <"OptionInfo">, <"LicenseInfo">
SYSTem:LKEY:LIST?
SYSTem:LKEY:WAVEform:ADD <string>
SYSTem:LKEY:WAVEform:CLEar <int>
SYSTem:LKEY:WAVEform:FREE?
SYSTem:LKEY:WAVEform:LOCK <int>
SYSTem:LKEY:WAVEform:NAME? <int>
SYSTem:LKEY:WAVEform:REPLace <int>, <string>
SYSTem:LKEY:WAVEform:STaTus? <int>
SYSTem:LKEY:WAVEform:UID? <int>
SYSTem:LKEY:WAVEform:USED?
```

```

SYSTEM:MODule:DEFault "<mnemonic>"
SYSTEM:MODule:DEFault?
SYSTEM:MODule:ENABle "<mnemonic>", 0 | 1
SYSTEM:MODule:ENABle? "<mnemonic>"
SYSTEM:MODule:INDex?
SYSTEM:MODule:LIST?
SYSTEM:MODule:MNEMonic?
SYSTEM:MODule:MODEl?
SYSTEM:MODule:NAME?
SYSTEM:MODule:SERial?
SYSTEM:OPTions?
SYSTEM:PDOWn [NORMal | FORCe]
SYSTEM:PON:APPLication:LLIST <stringofINSTrument:SElectnames>
SYSTEM:PON:APPLication:LLIST?
SYSTEM:PON:APPLication:VMEMory[:AVAILable]?
SYSTEM:PON:APPLication:VMEMory:TOTal?
SYSTEM:PON:APPLication:VMEMory:USED?
SYSTEM:PON:APPLication:VMEMory:USED:NAME? <INSTrument:SElectname>
SYSTEM:PON:MODE SA | BASIC | ADEMOD | NFIGURE | PNOISE | CDMA2K | TDSCDMA
| VSA | VSA89601 | WCDMA | WIMAXOFDMA
SYSTEM:PON:MODE?
SYSTEM:PON:TIME?
SYSTEM:PON:TYPE MODE | USER | LAST
SYSTEM:PON:TYPE PRESet
SYSTEM:PON:TYPE?
SYSTEM:PRESet
SYSTEM:PRESet:TYPE FACTory | MODE | USER
SYSTEM:PRESet:TYPE?
SYSTEM:PRESet:USER
SYSTEM:PRESet:USER:ALL
SYSTEM:PRESet:USER:SAVE
SYSTEM:PRINT:THEME TDColor | TDMonochrome | FCOlor | FMONochrome
SYSTEM:PRINT:THEME?
SYSTEM:PUP:PROcEss
SYSTEM:SECurity:USB:WPROtect[:ENABle] ON | OFF | 0 | 1
SYSTEM:SECurity:USB:WPROtect[:ENABle]?
SYSTEM:SHOW OFF | ERRor | SYSTem | HARDWare | LXI | HWStatistics |
ALIGNment | SOFTWare | CAPplication
SYSTEM:SHOW?
SYSTEM:TEST:WCTS:[ALL]
SYSTEM:TEST:WCTS:FEC
SYSTEM:TEST:WCTS:FEC:RESult?
SYSTEM:TEST:WCTS:SHOW:RESult FEC
SYSTEM:TIME "<hour>, <minute>, <second>"
SYSTEM:TIME?
SYSTEM:VERSion?
TRACE:SPECTrum:STRace[:STATe] OFF | ON | 0 | 1
TRACE:SPECTrum:STRace[:STATe]?
TRIGger:<measurement>[:SEquence]:IQ:SOURce EXTernal1 | EXTernal2 |
IMMediate | IQMag | IDEMod | QDEMod | IINPut | QINPut | AIQMag
TRIGger:<measurement>[:SEquence]:IQ:SOURce?

```

3 Programming the Test Set

List of SCPI Commands

```
TRIGger:<measurement>[:SEquence]:RF:SOURce EXTernal1 | EXTernal2 |
IMMediate | LINE | FRAME | RFBurst | VIDEo | IF | ALARm | LAN | TV
TRIGger:<measurement>[:SEquence]:RF:SOURce?
TRIGger:<measurement>[:SEquence]:SOURce EXTernal1 | EXTernal2 | IMMediate
| LINE | FRAME | RFBurst | VIDEo | IF | ALARm | LAN | IQMag | IDEMod |
QDEMod | IINPut | QINPut | AIQMag | TV
TRIGger:<measurement>[:SEquence]:SOURce?
TRIGger[:SEquence]:ATRigger <time>
TRIGger[:SEquence]:ATRigger?
TRIGger[:SEquence]:ATRigger:STATE OFF | ON | 0 | 1
TRIGger[:SEquence]:ATRigger:STATE?
TRIGger[:SEquence]:DELAy <time>
TRIGger[:SEquence]:DELAy?
TRIGger[:SEquence]:DELAy:STATE OFF | ON | 0 | 1
TRIGger[:SEquence]:DELAy:STATE?
TRIGger[:SEquence]:EXTernal1:DELAy <time>
TRIGger[:SEquence]:EXTernal:DELAy
TRIGger[:SEquence]:EXTernal2:DELAy <time>
TRIGger[:SEquence]:EXTernal2:DELAy?
TRIGger[:SEquence]:EXTernal1:DELAy?
TRIGger[:SEquence]:EXTernal1:DELAy:COMPensation OFF | ON | 0 | 1
TRIGger[:SEquence]:EXTernal2:DELAy:COMPensation OFF | ON | 0 | 1
TRIGger[:SEquence]:EXTernal1:DELAy:COMPensation?
TRIGger[:SEquence]:EXTernal2:DELAy:COMPensation?
TRIGger[:SEquence]:EXTernal1:DELAy:STATE OFF | ON | 0 | 1
TRIGger[:SEquence]:EXTernal2:DELAy:STATE OFF | ON | 0 | 1
TRIGger[:SEquence]:EXTernal1:DELAy:STATE?
TRIGger[:SEquence]:EXTernal2:DELAy:STATE?
TRIGger[:SEquence]:EXTernal2:LEVEl
TRIGger[:SEquence]:EXTernal1:LEVEl <level>
TRIGger[:SEquence]:EXTernal:LEVEl
TRIGger[:SEquence]:EXTernal2:LEVEl?
TRIGger[:SEquence]:EXTernal1:LEVEl?
TRIGger[:SEquence]:EXTernal2:SLOPe POSitive | NEGative
TRIGger[:SEquence]:EXTernal:SLOPe
TRIGger[:SEquence]:EXTernal1:SLOPe POSitive | NEGative
TRIGger[:SEquence]:EXTernal1:SLOPe?
TRIGger[:SEquence]:EXTernal2:SLOPe?
TRIGger[:SEquence]:FRAME:ADJust <time>
TRIGger[:SEquence]:FRAME:DELAy <time>
TRIGger[:SEquence]:FRAME:DELAy?
TRIGger[:SEquence]:FRAME:DELAy:STATE OFF | ON | 0 | 1
TRIGger[:SEquence]:FRAME:DELAy:STATE?
TRIGger[:SEquence]:FRAME:EXTernal2:LEVEl
TRIGger[:SEquence]:FRAME:EXTernal1:LEVEl
TRIGger[:SEquence]:FRAME:EXTernal1:SLOPe
TRIGger[:SEquence]:FRAME:EXTernal2:SLOPe
TRIGger[:SEquence]:FRAME:OFFSet <time>
TRIGger[:SEquence]:FRAME:OFFSet?
TRIGger[:SEquence]:FRAME:OFFSet:DISPlay:RESet
TRIGger[:SEquence]:FRAME:PERiod <time>
TRIGger[:SEquence]:FRAME:PERiod?
```

```

TRIGger[:SEQuence]:FRAMe:RFBurst:LEVel:ABSolute
TRIGger[:SEQuence]:FRAMe:RFBurst:SLOPe
TRIGger[:SEQuence]:FRAMe:SYNC EXTernal
TRIGger[:SEQuence]:FRAMe:SYNC EXTernal1 | EXTernal2 | RFBurst | OFF
TRIGger[:SEQuence]:FRAMe:SYNC?
TRIGger[:SEQuence]:HOLDoFF <time>
TRIGger[:SEQuence]:HOLDoFF?
TRIGger[:SEQuence]:HOLDoFF:STATe OFF | ON | 0 | 1
TRIGger[:SEQuence]:HOLDoFF:STATe?
TRIGger[:SEQuence]:HOLDoFF:TYPE NORMAl | ABOVe | BELow
TRIGger[:SEQuence]:HOLDoFF:TYPE?
TRIGger[:SEQuence]:IF:LEVel
TRIGger[:SEQuence]:IF:LEVel?
TRIGger[:SEQuence]:IF:SLOPe NEGative | POSitive
TRIGger[:SEQuence]:IF:SLOPe?
TRIGger[:SEQuence]:OFFSet <time>
TRIGger[:SEQuence]:OFFSet?
TRIGger[:SEQuence]:OFFSet:STATe OFF | ON | 0 | 1
TRIGger[:SEQuence]:OFFSet:STATe?
TRIGger[:SEQuence]:RFBurst:DELay <time>
TRIGger[:SEQuence]:RFBurst:DELay?
TRIGger[:SEQuence]:RFBurst:DELay:STATe OFF | ON | 0 | 1
TRIGger[:SEQuence]:RFBurst:DELay:STATe?
TRIGger[:SEQuence]:RFBurst:LEVel
TRIGger[:SEQuence]:RFBurst:LEVel:ABSolute <ampl>
TRIGger[:SEQuence]:RFBurst:LEVel:ABSolute?
TRIGger[:SEQuence]:RFBurst:LEVel:RELative <rel_ampl>
TRIGger[:SEQuence]:RFBurst:LEVel:RELative?
TRIGger[:SEQuence]:RFBurst:LEVel:TYPE ABSolute | RELative
TRIGger[:SEQuence]:RFBurst:LEVel:TYPE?
TRIGger[:SEQuence]:RFBurst:SLOPe POSitive | NEGative
TRIGger[:SEQuence]:RFBurst:SLOPe?
TRIGger[:SEQuence]:SLOPe POSitive | NEGative
TRIGger[:SEQuence]:SLOPe?
TRIGger[:SEQuence]:SOURCe EXTernal
TRIGger[:SEQuence]:VIDeo:DELay <time>
TRIGger[:SEQuence]:VIDeo:DELay?
TRIGger[:SEQuence]:VIDeo:DELay:STATe OFF | ON | 0 | 1
TRIGger[:SEQuence]:VIDeo:DELay:STATe?
TRIGger[:SEQuence]:VIDeo:LEVel <ampl>
TRIGger[:SEQuence]:VIDeo:LEVel?
TRIGger[:SEQuence]:VIDeo:SLOPe POSitive | NEGative
TRIGger[:SEQuence]:VIDeo:SLOPe?
TRIGger|TRIGger1|TRIGger2[:SEQuence]:OUTPut HSWP | MEASuring | MAIN | GATE
| GTRigger | OEVEN | SPOint | SSweep | SSETtled | S1Marker | S2Marker |
S3Marker | S4Marker | OFF
TRIGger|TRIGger1|TRIGger2[:SEQuence]:OUTPut?
TRIGger|TRIGger1|TRIGger2[:SEQuence]:OUTPut:POLarity POSitive | NEGative
TRIGger|TRIGger1|TRIGger2[:SEQuence]:OUTPut:POLarity?

```

STATus Subsystem

The following diagram shows the entire Status Register Subsystem implementation of the X Series instruments.

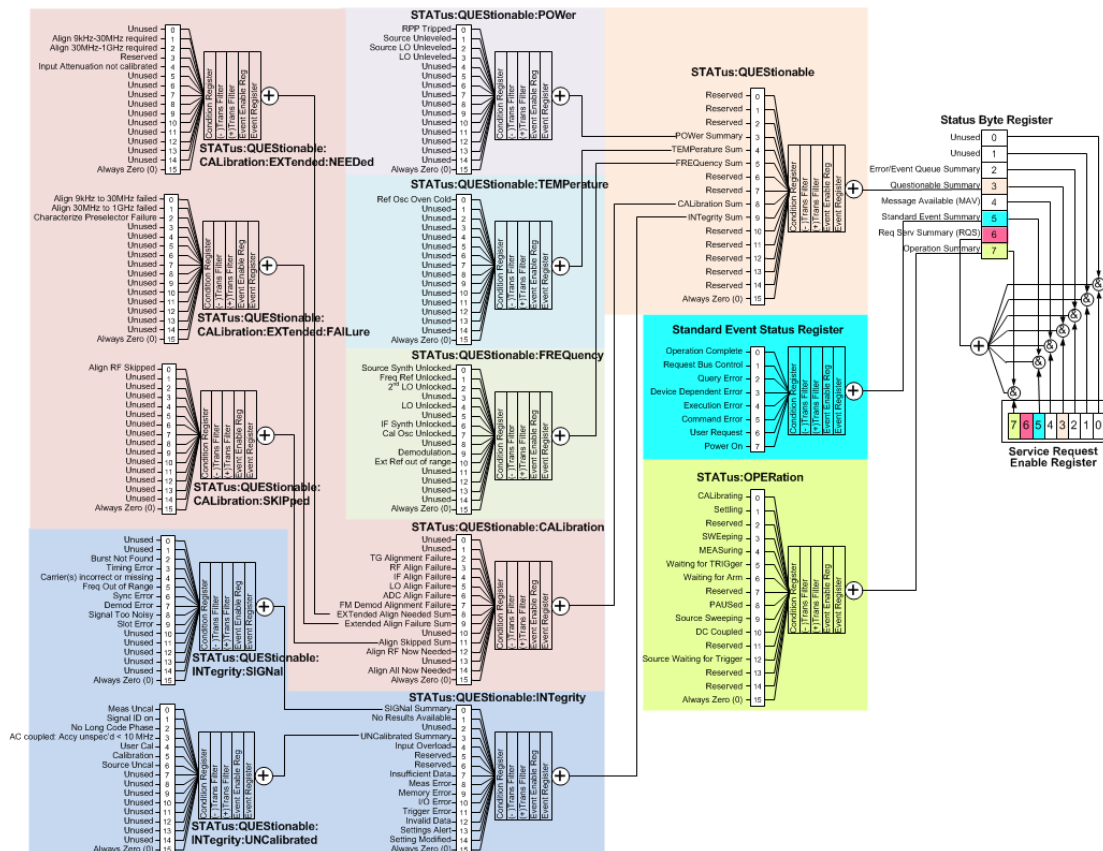

Detailed Description

The STATus subsystem remote commands set and query the status hardware registers. This system of registers monitors various events and conditions in the instrument. Software written to control the instrument may need to monitor some of these events and conditions.

NOTE All status register commands are sequential. Most commands can be started immediately and will overlap with any existing commands that are already running. This is not true of status commands. All the commands in the spectrum analyzer are assumed to be overlapped unless a command description specifically says that it is sequential.

What Are Status Registers

The status system contains multiple registers that are arranged in a hierarchical order. The lower-level status registers propagate their data to the higher-level registers in the data structures by means of summary bits. The status byte register is at the top of the hierarchy and contains general status information for the instrument's events and conditions. All other individual registers are used to determine the specific events or conditions. For a diagram of the registers and their interconnections, see above.

The operation and questionable status registers are sets of registers that monitor the overall instrument condition. They are accessed with the STATus:OPERation and STATus:QUEStionable commands in the STATus command subsystem. Each register set is made up of five registers:

- Condition Register—It reports the real-time state of the signals monitored by this register set. There is no latching or buffering for a condition register.
- Positive Transition Register—This filter register controls which signals will set a bit in the event register when the signal makes a low to high transition (when the condition bit changes from 0 to 1).
- Negative Transition Register—This filter register controls which signals will set a bit in the event register when the signal makes a high to low transition (when the condition bit changes from 1 to 0).
- Event Register—It latches any signal state changes, in the way specified by the filter registers. Bits in the event register are never cleared by signal state changes. Event registers are cleared when read. They are also cleared by *CLS and by presetting the instrument.
- Event Enable Register—It controls which of the bits, being set in the event register, will be summarized as a single output for the register set. Summary bits are then used by the next higher register.

The STATus:QUEStionable registers report abnormal operating conditions. The status register hierarchy is:

1. The summary outputs from the six STATus:QUEStionable:<keyword> detail registers are inputs to the STATus:QUEStionable register.
2. The summary output from the STATus:QUEStionable register is an input to the Status Byte Register. See the overall system in Figure at the beginning of this section.

The STATus:OPERation register set has no summarized inputs. The inputs to the STATus:OPERation:CONDition register indicate the real time state of the instrument. The STATus:OPERation:EVENT register summary output is an input to the Status Byte Register.

What Are Status Register SCPI Commands

Most monitoring of the instrument conditions is done at the highest level using the IEEE common commands indicated below. Complete command descriptions are available in the IEEE commands section at the beginning of the language reference. Individual status registers can be set and queried using the commands in the STATus subsystem of the language reference.

- *CLS (clear status) clears the status byte by emptying the error queue and clearing all the event registers.
- *ESE, *ESE? (event status enable) sets and queries the bits in the enable register part of the standard event status register.
- *ESR? (event status register) queries and clears the event register part of the standard event status register.
- *OPC, *OPC? (operation complete) sets the standard event status register to monitor the completion of all commands. The query stops any new commands from being processed until the current processing is complete, then returns a '1'.
- *PSC, *PSC? (power-on state clear) sets the power-on state so that it clears the service request enable register and the event status enable register at power on.
- *SRE, *SRE? (service request enable) sets and queries the value of the service request enable register.

- *STB? (status byte) queries the value of the status byte register without erasing its contents.

How to Use the Status Registers

A program often needs to be able to detect and manage error conditions or changes in instrument status. There are two methods you can use to programmatically access the information in status registers:

- The polling method
- The service request (SRQ) method

In the polling method, the instrument has a passive role. It only tells the controller that conditions have changed when the controller asks the right question. In the SRQ method, the instrument takes a more active role. It tells the controller when there has been a condition change without the controller asking. Either method allows you to monitor one or more conditions.

The polling method works well if you do not need to know about changes the moment they occur. The SRQ method should be used if you must know immediately when a condition changes. To detect a change using the polling method, the program must repeatedly read the registers.

Use the SRQ method when:

- you need time-critical notification of changes
- you are monitoring more than one device which supports SRQs
- you need to have the controller do something else while waiting
- you can't afford the performance penalty inherent to polling

Use polling when:

- your programming language/development environment does not support SRQ interrupts
- you want to write a simple, single-purpose program and don't want the added complexity of setting up an SRQ handler
- To monitor a condition:
 - a. Determine which register contains the bit that reports the condition.
 - b. Send the unique SCPI query that reads that register.
 - c. Examine the bit to see if the condition has changed.

You can monitor conditions in different ways.

- Check the current instrument hardware and firmware status.

Do this by querying the condition registers which continuously monitor status. These registers represent the current state of the instrument. Bits in a condition register are updated in real time. When the condition monitored by a particular bit becomes true, the bit is set to 1. When the condition becomes false, the bit is reset to 0.

- Monitor a particular condition (bit).

You can enable a particular bit(s), using the event enable register. The instrument will then monitor that particular condition(s). If the bit becomes true (0 to 1 transition) in the event register, it will stay set until the

event register is cleared. Querying the event register allows you to detect that this condition occurred even if the condition no longer exists. The event register can only be cleared by querying it or sending the *CLS command.

- Monitor a particular type of change in a condition (bit).
 - The transition registers are preset to register if the condition goes from 0 to 1 (false to true, or a positive transition).
 - This can be changed so the selected condition is detected if the bit goes from 1 to 0 (true to false, or a negative transition).
 - It can also be set for both types of transitions occurring.
 - Or it can be set for neither transition. If both transition registers are set to 0 for a particular bit position, that bit will not be set in the event register for either type of change.

Using a Status Register

Each bit in a register is represented by a numerical value based on its location. See figure below. This number is sent with the command to enable a particular bit. If you want to enable more than one bit, you would send the sum of all the bits that you want to monitor.

Figure: Status Register Bit Values

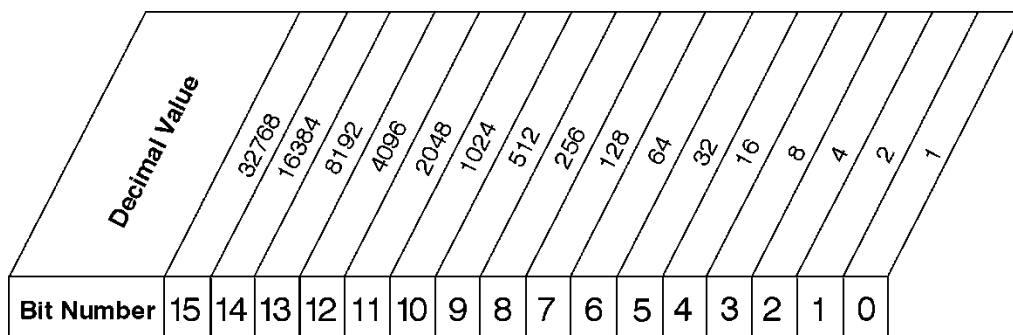

STATus:OPERation:ENABLE < num >
STATus:OPERation:ENABLE?

Standard Operation Event Enable Register

ck730a

Bit 15 is not used to report status.

Example 1:

1. To enable bit 0 and bit 6 of standard event status register, you would send the command *ESE 65 because 1 + 64 = 65.
2. The results of a query are evaluated in a similar way. If the *STB? command returns a decimal value of 140, (140 = 128 + 8 + 4) then bit 7 is true, bit 3 is true and bit 2 is true.

Example 2:

1. Suppose you want to know if an Auto-trigger Timeout occurs, but you only cared about that specific condition. So you would want to know what was happening with bit 10 in the Status Questionable Integrity register, and not about any other bits.
2. It's usually a good idea to start by clearing all the status registers with *CLS.

3. Sending the `STAT:QUES:INT:ENAB 1024` command lets you monitor only bit 10 events, instead of the default monitoring all the bits in the register. The register default is for positive transition events (0 to 1 transition). That is, when an auto-trigger timeout occurs. If instead, you wanted to know when the Auto-trigger timeout condition is cleared, then you would set the `STAT:QUES:INT:PTR 0` and the `STAT:QUES:INT:NTR 32767`.
4. So now the only output from the Status Questionable Integrity register will come from a bit 10 positive transition. That output goes to the Integrity Sum bit 9 of the Status Questionable register.
5. You can do a similar thing with this register to only look at bit 9 using, `STAT:QUES:ENAB 512`.
6. The Status Questionable register output goes to the “Status Questionable Summary” bit 3 of the Status Byte Register. The output from this register can be enabled using the `*SRE 8` command.
7. Finally, you would use the serial polling functionality available for the particular bus/software that you are using to monitor the Status Byte Register. (You could also use `*STB?` to poll the Status Byte Register.)

Using the Service Request (SRQ) Method

Your language, bus, and programming environment must be able to support SRQ interrupts. (For example, BASIC used with VXI-11.3 (GPIB over LAN). When you monitor a condition with the SRQ method, you must:

1. Determine which bit monitors the condition.
2. Determine how that bit reports to the request service (RQS) bit of the status byte.
3. Send SCPI commands to enable the bit that monitors the condition and to enable the summary bits that report the condition to the RQS bit.
4. Enable the controller to respond to service requests.

When the condition changes, the instrument sets its RQS bit. The controller is informed of the change as soon as it occurs. As a result, the time the controller would otherwise have used to monitor the condition can be used to perform other tasks. Your program determines how the controller responds to the SRQ.

Generating a Service Request

To use the SRQ method, you must understand how service requests are generated. Bit 6 of the status byte register is the request service (RQS) bit. The `*SRE` command is used to configure the RQS bit to report changes in instrument status. When such a change occurs, the RQS bit is set. It is cleared when the status byte register is queried using `*SRE?` (with a serial poll.) It can be queried without erasing the contents with `*STB?`.

When a register set causes a summary bit in the status byte to change from 0 to 1, the instrument can initiate the service request (SRQ) process. However, the process is only initiated if both of the following conditions are true:

- The corresponding bit of the service request enable register is also set to 1.
- The instrument does not have a service request pending. (A service request is considered to be pending between the time the instrument’s SRQ process is initiated and the time the controller reads the status byte register.)

The SRQ process sets the SRQ true. It also sets the status byte's request service (RQS) bit to 1. Both actions are necessary to inform the controller that the instrument requires service. Setting the SRQ line only informs the controller that some device on the bus requires service. Setting the RQS bit allows the controller to determine which instrument requires service.

If your program enables the controller to detect and respond to service requests, it should instruct the controller to perform a serial poll when the SRQ is set true. Each device on the bus returns the contents of its status byte register in response to this poll. The device whose RQS bit is set to 1 is the device that requested service.

When you read the instrument's status byte register with a serial poll, the RQS bit is reset to 0. Other bits in the register are not affected.

If the status register is configured to SRQ on end-of-measurement and the measurement is in continuous mode, then restarting a measurement (INIT command) can cause the measuring bit to pulse low. This causes an SRQ when you have not actually reached the "end-of-measurement" condition. To avoid this:

1. Set INITiate:CONTinuous off.
2. Set/enable the status registers.
3. Restart the measurement (send INIT).

Status Register System

The hardware status registers are combined to form the instrument status system. Specific status bits are assigned to monitor various aspects of the instrument operation and status. See the diagram of the status system above for information about the bit assignments and status register interconnections.

The Status Byte Register

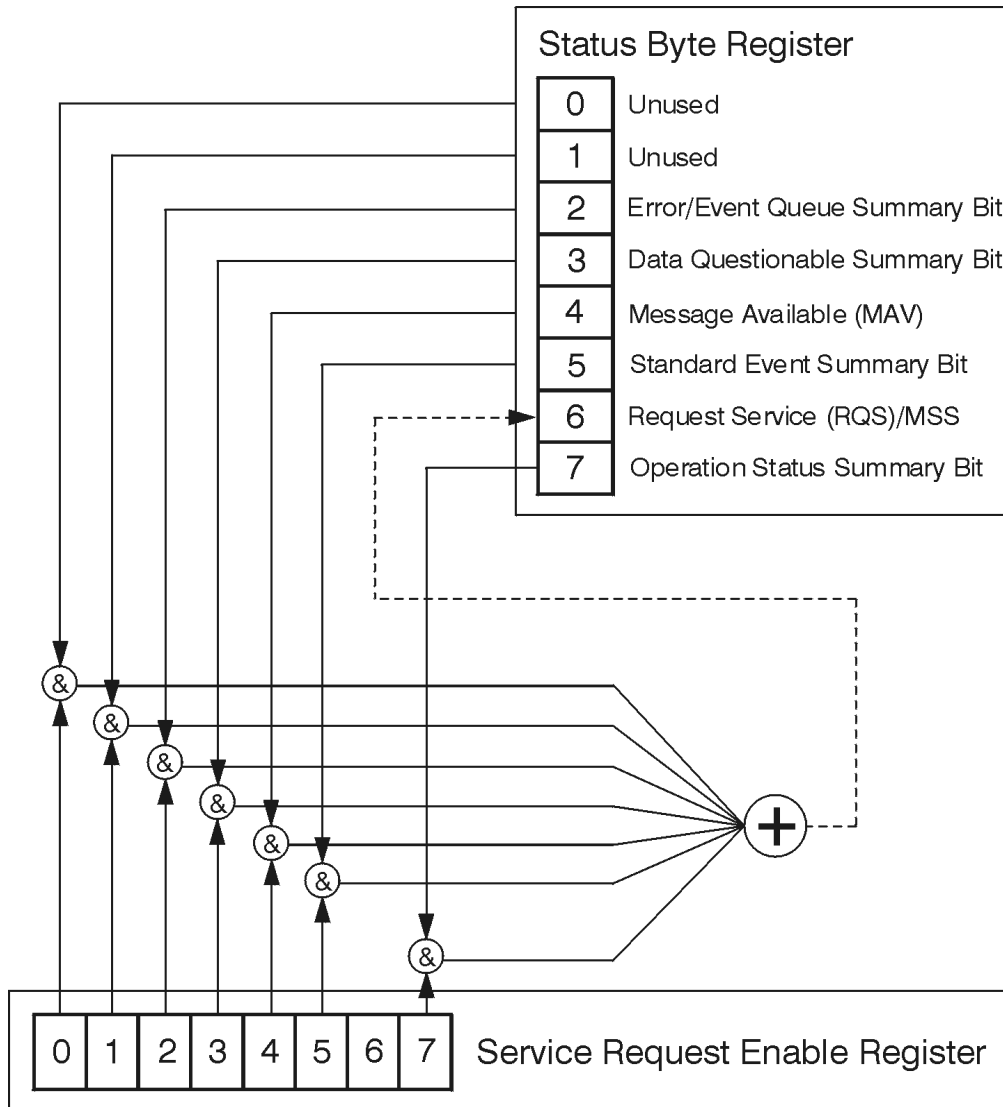

ck776a

The RQS bit is read and reset by a serial poll. The same bit position (MSS) is read, non-destructively by the *STB? command. If you serial poll bit 6 it is read as RQS, but if you send *STB it reads bit 6 as MSS. For more information refer to IEEE 488.2 standards, section 11.

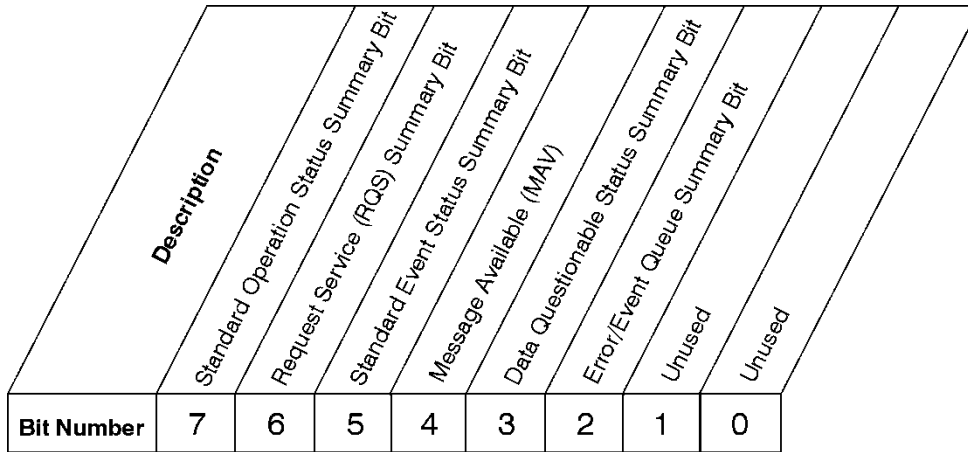

*STB?

Status Byte Register

ck725a

Bit	Description
0, 1	These bits are always set to 0.
2	A 1 in this bit position indicates that the SCPI error queue is not empty which means that it contains at least one error message.
3	A 1 in this bit position indicates that the data questionable summary bit has been set. The data questionable event register can then be read to determine the specific condition that caused this bit to be set.
4	A 1 in this bit position indicates that the instrument has data ready in the output queue. There are no lower status groups that provide input to this bit.
5	A 1 in this bit position indicates that the standard event summary bit has been set. The standard event status register can then be read to determine the specific event that caused this bit to be set.
6	A 1 in this bit position indicates that the instrument has at least one reason to report a status change. This bit is also called the master summary status bit (MSS).
7	A 1 in this bit position indicates that the standard operation summary bit has been set. The standard operation event register can then be read to determine the specific condition that caused this bit to be set.

To query the status byte register, send the command *STB?. The response will be the decimal sum of the bits which are set to 1. For example, if bit number 7 and bit number 3 are set to 1, the decimal sum of the 2 bits is 128 plus 8. So the decimal value 136 is returned. The *STB command does not clear the status register.

In addition to the status byte register, the status byte group also contains the service request enable register. This register lets you choose which bits in the status byte register will trigger a service request.

Send the *SRE <integer> command where <integer> is the sum of the decimal values of the bits you want to enable plus the decimal value of bit 6. For example, assume that you want to enable bit 7 so that whenever the standard operation status register summary bit is set to 1 it will trigger a service request. Send the command *SRE 192 (because $192 = 128 + 64$). You must always add 64 (the numeric value of RQS

bit 6) to your numeric sum when you enable any bits for a service request. The command *SRE? returns the decimal value of the sum of the bits previously enabled with the *SRE <integer> command.

The service request enable register presets to zeros (0).

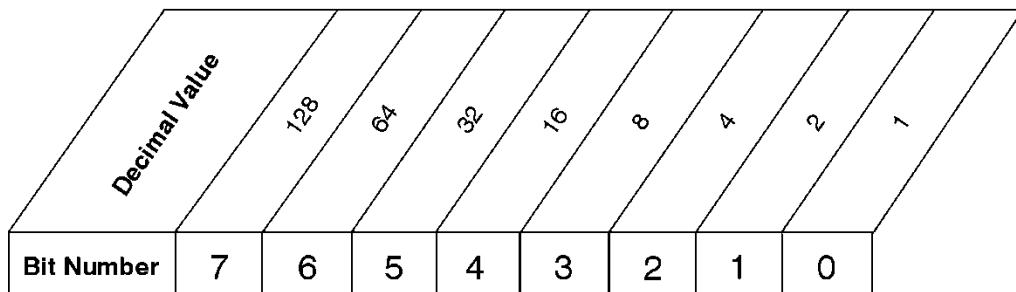

*SRE <num>
 *SRE?

Service Request Enable Register

ck726a

Standard Event Status Register

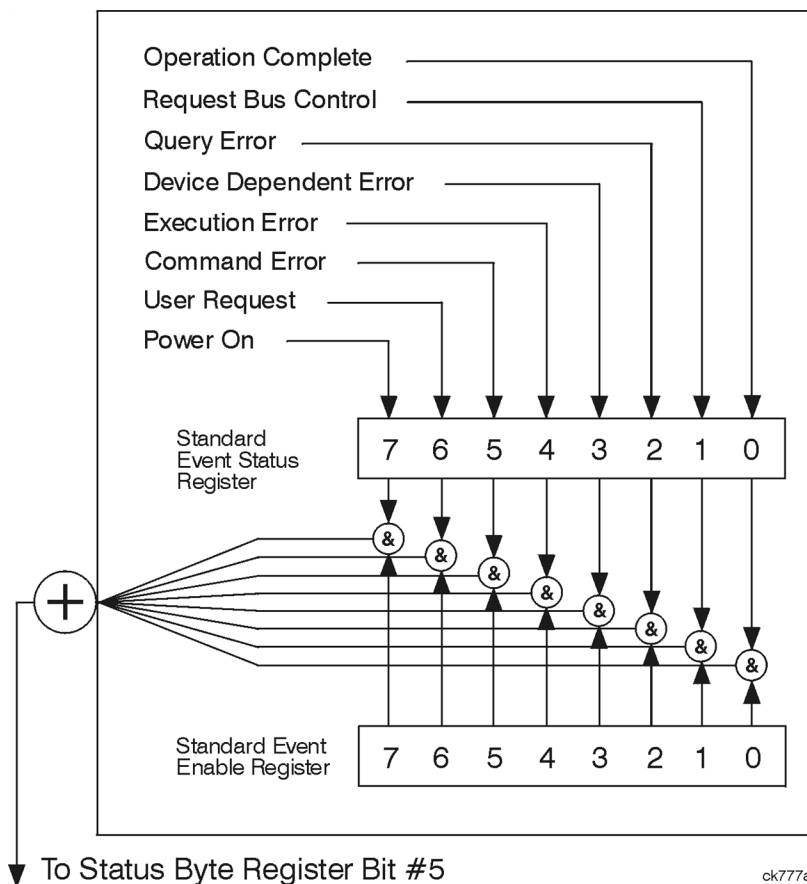

The standard event status register contains the following bits:

Description								
	<i>Power On</i>	<i>User Request Key (Local)</i>	<i>Command Error</i>	<i>Execution Error</i>	<i>Device Dependent Error</i>	<i>Query Error</i>	<i>Request Control</i>	<i>Operation Complete</i>
Bit Number	7	6	5	4	3	2	1	0

*ESR?

Standard Event Status Register

ck727a

Bit	Description
0	A 1 in this bit position indicates that all pending operations were completed following execution of the *OPC command.
1	This bit is for GPIB handshaking to request control. Currently it is set to 0 because there are no implementations where the spectrum analyzer controls another instrument.
2	A 1 in this bit position indicates that a query error has occurred. Query errors have SCPI error numbers from -499 to -400.
3	A 1 in this bit position indicates that a device dependent error has occurred. Device dependent errors have SCPI error numbers from -399 to -300 and 1 to 32767.
4	A 1 in this bit position indicates that an execution error has occurred. Execution errors have SCPI error numbers from -299 to -200.
5	A 1 in this bit position indicates that a command error has occurred. Command errors have SCPI error numbers from -199 to -100.
6	A 1 in this bit position indicates that the LOCAL key has been pressed. This is true even if the instrument is in local lockout mode.
7	A 1 in this bit position indicates that the instrument has been turned off and then on.

The standard event status register is used to determine the specific event that set bit 5 in the status byte register. To query the standard event status register, send the command *ESR?. The response will be the decimal sum of the bits which are enabled (set to 1). For example, if bit number 7 and bit number 3 are enabled, the decimal sum of the 2 bits is 128 plus 8. So the decimal value 136 is returned.

In addition to the standard event status register, the standard event status group also contains a standard event status enable register. This register lets you choose which bits in the standard event status register will set the summary bit (bit 5 of the status byte register) to 1. Send the *ESE <integer> command where <integer> is the sum of the decimal values of the bits you want to enable. For example, to enable bit 7 and bit 6 so that whenever either of those bits is set to 1, the standard event status summary bit of the status

byte register will be set to 1, send the command *ESE 192 (128 + 64). The command *ESE? returns the decimal value of the sum of the bits previously enabled with the *ESE <integer> command.

The standard event status enable register presets to zeros (0).

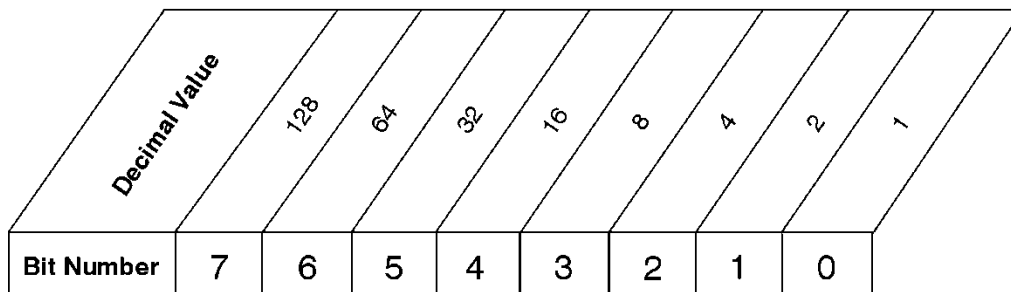

*ESE <num>
 *ESE?

Standard Event Status Enable Register

ck728a

Operation and Questionable Status Registers

The operation and questionable status registers are registers that monitor the overall instrument condition. They are accessed with the STATus:OPERation and STATus:QUEStionable commands in the STATus command subsystem. See the figure at the beginning of this chapter.

Operation Status Register

The operation status register monitors the current instrument measurement state. It checks to see if the instrument is calibrating, sweeping, or waiting for a trigger. For more information see the *OPC? command located in the IEEE Common Commands section.

Bit	Condition	Operation
0	Calibrating	The instrument is busy executing its Align Now process
3	Sweeping	The instrument is busy taking a sweep.
4	Measuring	The instrument is busy making a measurement. Measurements often require multiple sweeps. They are initiated by keys under the MEASURE key or with the MEASure group of commands. The bit is valid for most X-Series Modes.
5	Waiting for trigger	The instrument is waiting for the trigger conditions to be met, then it will trigger a sweep or measurement.

Questionable Status Register

The questionable status register monitors the instrument's condition to see if anything questionable has happened to it. It is looking for anything that might cause an error or a bad measurement like a hardware problem, an out of calibration situation, or a unusual signal. All the bits are summary bits from lower-level event registers.

Bit	Condition	Operation
-----	-----------	-----------

3	Power summary	The instrument hardware has detected a power unlevelled condition.
4	Temperature summary	The instrument is still warming up.
5	Frequency summary	The instrument hardware has detected an unlocked condition or a problem with the external frequency reference.
8	Calibration summary	The instrument has detected a hardware problem while doing the automatic internal alignment process.
9	Integrity summary	The instrument has detected a questionable measurement condition such as: bad timing, bad signal/data, timeout problem, signal overload, or "meas uncal".

STATus Subsystem Command Descriptions

The STATus subsystem controls the SCPI-defined instrument status reporting structures. Each status register has a set of five commands used for querying or masking that particular register.

Numeric values for bit patterns can be entered using decimal or hexadecimal representations. (i.e. 0 to 32767 is equivalent to #H0 to #H7FFF. It is also equal to all ones, 111111111111111) See the SCPI Basics information about using bit patterns for variable parameters.

Operation Register

"Operation Condition Query" on page 73

"Operation Enable" on page 74

"Operation Event Query" on page 74

"Operation Negative Transition" on page 74

"Operation Positive Transition" on page 75

Operation Condition Query

This query returns the decimal value of the sum of the bits in the Status Operation Condition register.

NOTE

The data in this register is continuously updated and reflects the current conditions.

Mode	All
Remote Command	:STATus:OPERation:CONDition?
Example	STAT:OPER:COND?
Preset	0
Status Bits/OPC dependencies	Sequential command
Initial S/W Revision	Prior to A.02.00

Operation Enable

This command determines which bits in the Operation Event register, will set the Operation Status Summary bit (bit 7) in the Status Byte Register. The variable <integer> is the sum of the decimal values of the bits you want to enable.

NOTE

The preset condition is to have all bits in this enable register set to 0. To have any Operation Events reported to the Status Byte Register, one or more bits need to be set to 1.

Mode	All
Remote Command	:STATus:OPERation:ENABle <integer> :STATus:OPERation:ENABle?
Example	STAT:OPER:ENAB 1 Sets the register so that Align Now operation will be reported to the Status Byte Register.
Preset	0
Min	0
Max	32767
Status Bits/OPC dependencies	Sequential command
Initial S/W Revision	Prior to A.02.00

Operation Event Query

This query returns the decimal value of the sum of the bits in the Operation Event register.

NOTE

The register requires that the associated PTR or NTR filters be set before a condition register bit can set a bit in the event register. The data in this register is latched until it is queried. Once queried, the register is cleared.

Mode	All
Remote Command	:STATus:OPERation[:EVENT]?
Example	STAT:OPER?
Preset	0
Status Bits/OPC dependencies	Sequential command
Initial S/W Revision	Prior to A.02.00

Operation Negative Transition

This command determines which bits in the Operation Condition register will set the corresponding bit in the Operation Event register when the condition register bit has a negative transition (1 to 0). The variable <integer> is the sum of the decimal values of the bits that you want to enable.

Mode	All
Remote Command	:STATus:OPERation:NTRansition <integer> :STATus:OPERation:NTRansition?
Example	STAT:OPER:NTR 1 Align Now operation complete will be reported to the Status Byte Register.
Preset	0
Min	0
Max	32767
Status Bits/OPC dependencies	Sequential command
Initial S/W Revision	Prior to A.02.00

Operation Positive Transition

This command determines which bits in the Operation Condition register will set the corresponding bit in the Operation Event register when the condition register bit has a positive transition (0 to 1). The variable <integer> is the sum of the decimal values of the bits that you want to enable.

Mode	All
Remote Command	:STATus:OPERation:PTRansition <integer> :STATus:OPERation:PTRansition?
Example	STAT:OPER:PTR 1 Align Now operation beginning will be reported to the Status Byte Register.
Preset	32767
Min	0
Max	32767
Status Bits/OPC dependencies	Sequential command
Initial S/W Revision	Prior to A.02.00

Preset the Status Byte

Sets bits in most of the enable and transition registers to their default state. It presets all the Transition Filters, Enable Registers, and the Error/Event Queue Enable. It has no effect on Event Registers, Error/Event QUEUE, IEEE 488.2 ESE, and SRE Registers as described in IEEE Standard 488.2–1992, IEEE Standard Codes, Formats, Protocols, and Common Commands for Use with ANSI/IEEE Std 488.1–1987. New York, NY, 1992.

Remote Command	:STATus:PRESet
Example	STAT:PRESet
Initial S/W Revision	Prior to A.02.00

Questionable Register

"Questionable Condition " on page 76

"Questionable Enable " on page 76

"Questionable Event Query " on page 77

"Questionable Negative Transition " on page 77

"Questionable Positive Transition" on page 77

Questionable Condition

This query returns the decimal value of the sum of the bits in the Questionable Condition register.

NOTE The data in this register is continuously updated and reflects the current conditions.

Mode	All
Remote Command	:STATus:QUEStionable:CONDition?
Example	STAT:QUES:COND?
Preset	0
Status Bits/OPC dependencies	Sequential command
Initial S/W Revision	Prior to A.02.00

Questionable Enable

This command determines which bits in the Questionable Event register will set the Questionable Status Summary bit (bit3) in the Status Byte Register. The variable <integer> is the sum of the decimal values of the bits you want to enable.

NOTE The preset condition is all bits in this enable register set to 0. To have any Questionable Events reported to the Status Byte Register, one or more bits need to be set to 1. The Status Byte Event Register should be queried after each measurement to check the Questionable Status Summary (bit 3). If it is equal to 1, a condition during the test may have made the test results invalid. If it is equal to 0, this indicates that no hardware problem or measurement problem was detected by the analyzer.

Mode	All
Remote Command	:STATus:QUEStionable:ENABle <integer> :STATus:QUEStionable:ENABle?
Example	STAT:OPER:PTR 1 Align Now operation beginning will be reported to the Status Byte Register.
Preset	0
Min	0
Max	32767
Status Bits/OPC dependencies	Sequential command

Initial S/W Revision	Prior to A.02.00
----------------------	------------------

Questionable Event Query

This query returns the decimal value of the sum of the bits in the Questionable Event register.

NOTE The register requires that the associated PTR or NTR filters be set before a condition register bit can set a bit in the event register. The data in this register is latched until it is queried. Once queried, the register is cleared.

Mode	All
Remote Command	:STATus:QUEStionable[:EVENT]?
Example	STAT:QUES?
Preset	0
Status Bits/OPC dependencies	Sequential command
Initial S/W Revision	Prior to A.02.00

Questionable Negative Transition

This command determines which bits in the Questionable Condition register will set the corresponding bit in the Questionable Event register when the condition register bit has a negative transition (1 to 0). The variable <integer> is the sum of the decimal values of the bits that you want to enable.

Mode	All
Remote Command	:STATus:QUEStionable:NTRansition <integer> :STATus:QUEStionable:NTRansition?
Example	STAT:QUES:NTR 16 Temperature summary 'questionable cleared' will be reported to the Status Byte Register.
Preset	0
Min	0
Max	32767
Status Bits/OPC dependencies	Sequential command
Initial S/W Revision	Prior to A.02.00

Questionable Positive Transition

This command determines which bits in the Questionable Condition register will set the corresponding bit in the Questionable Event register when the condition register bit has a positive transition (0 to 1). The variable <integer> is the sum of the decimal values of the bits that you want to enable.

Mode	All
Remote Command	:STATus:QUESTionable:PTRansition <integer> :STATus:QUESTionable:PTRansition?
Example	STAT:QUES:PTR 16 Temperature summary 'questionable asserted' will be reported to the Status Byte Register.
Preset	32767
Min	0
Max	32767
Status Bits/OPC dependencies	Sequential command
Initial S/W Revision	Prior to A.02.00

Questionable Calibration Register

- "Questionable Calibration Condition " on page 78
- "Questionable Calibration Enable " on page 78
- "Questionable Calibration Event Query " on page 79
- "Questionable Calibration Negative Transition " on page 79
- "Questionable Calibration Positive Transition " on page 80

Questionable Calibration Condition

This query returns the decimal value of the sum of the bits in the Questionable Calibration Condition register.

NOTE The data in this register is continuously updated and reflects the current conditions.

Mode	All
Remote Command	:STATus:QUESTionable:CALibration:CONDition?
Example	STAT:QUES:CAL:COND?
Preset	0
Status Bits/OPC dependencies	Sequential command
Initial S/W Revision	Prior to A.02.00

Questionable Calibration Enable

This command determines which bits in the Questionable Calibration Condition Register will set bits in the Questionable Calibration Event register, which also sets the Calibration Summary bit (bit 8) in the

Questionable Register. The variable <integer> is the sum of the decimal values of the bits you want to enable.

Mode	All
Remote Command	:STATus:QUEStionable:CALibration:ENABle <integer> :STATus:QUEStionable:CALibration:ENABle?
Example	STAT:QUES:CAL:ENAB 16384 Can be used to query if an alignment is needed, if you have turned off the automatic alignment process.
Min	0
Max	32767
Status Bits/OPC dependencies	Sequential command
Initial S/W Revision	Prior to A.02.00

Questionable Calibration Event Query

This query returns the decimal value of the sum of the bits in the Questionable Calibration Event register.

NOTE

The register requires that the associated PTR or NTR filters be set before a condition register bit can set a bit in the event register. The data in this register is latched until it is queried. Once queried, the register is cleared.

Mode	All
Remote Command	:STATus:QUEStionable:CALibration[:EVENT]?
Example	STAT:QUES:CAL?
Preset	0
Status Bits/OPC dependencies	Sequential command
Initial S/W Revision	Prior to A.02.00

Questionable Calibration Negative Transition

This command determines which bits in the Questionable Calibration Condition register will set the corresponding bit in the Questionable Calibration Event register when the condition register bit has a negative transition (1 to 0). The variable <integer> is the sum of the decimal values of the bits that you want to enable.

Mode	All
Remote Command	:STATus:QUEStionable:CALibration:NTRansition <integer> :STATus:QUEStionable:CALibration:NTRansition?
Example	STAT:QUES:CAL:NTR 16384 Alignment is not required.
Preset	0

Min	0
Max	32767
Status Bits/OPC dependencies	Sequential command
Initial S/W Revision	Prior to A.02.00

Questionable Calibration Positive Transition

This command determines which bits in the Questionable Calibration Condition register will set the corresponding bit in the Questionable Calibration Event register when the condition register bit has a positive transition (0 to 1). The variable <integer> is the sum of the decimal values of the bits that you want to enable.

Mode	All
Remote Command	:STATus:QUEStionable:CALibration:PTRansition <integer> :STATus:QUEStionable:CALibration:PTRansition?
Example	STAT:QUES:CAL:PTR 16384 Alignment is required.
Preset	32767
Min	0
Max	32767
Status Bits/OPC dependencies	Sequential command
Initial S/W Revision	Prior to A.02.00

Questionable Calibration Skipped Register

[Questionable Calibration Skipped Condition](#)

[Questionable Calibration Skipped Enable](#)

[Questionable Calibration Skipped Event Query](#)

[Questionable Calibration Skipped Negative Transition](#)

[Questionable Calibration Skipped Positive Transition](#)

Questionable Calibration Extended Failure Register

[Questionable Calibration Extended Failure Condition](#)

[Questionable Calibration Extended Failure Enable](#)

[Questionable Calibration Extended Failure Event Query](#)

[Questionable Calibration Extended Failure Negative Transition](#)

[Questionable Calibration Extended Failure Positive Transition](#)

Questionable Frequency Register

"Questionable Frequency Condition " on page 81

"Questionable Frequency Enable " on page 81

"Questionable Frequency Event Query " on page 82

"Questionable Frequency Negative Transition " on page 82

"Questionable Frequency Positive Transition " on page 82

Questionable Frequency Condition

This query returns the decimal value of the sum of the bits in the Questionable Frequency Condition register.

NOTE

The data in this register is continuously updated and reflects the current conditions.

Mode	All
Remote Command	:STATus:QUESTionable:FREQuency:CONDition?
Example	STAT:QUES:FREQ:COND?
Preset	0
Status Bits/OPC dependencies	Sequential command
Initial S/W Revision	Prior to A.02.00

Questionable Frequency Enable

This command determines which bits in the Questionable Frequency Condition Register will set bits in the Questionable Frequency Event register, which also sets the Frequency Summary bit (bit 5) in the Questionable Register. The variable <integer> is the sum of the decimal values of the bits you want to enable.

Mode	All
Remote Command	:STATus:QUESTionable:FREQuency:ENABle <integer> :STATus:QUESTionable:FREQuency:ENABle?
Example	STAT:QUES:FREQ:ENAB 2 Frequency Reference Unlocked will be reported to the Frequency Summary of the Status Questionable register.
Preset	32767
Min	0
Max	32767
Status Bits/OPC dependencies	Sequential command
Initial S/W Revision	Prior to A.02.00

Questionable Frequency Event Query

This query returns the decimal value of the sum of the bits in the Questionable Frequency Event register.

NOTE

The register requires that the associated PTR or NTR filters be set before a condition register bit can set a bit in the event register. The data in this register is latched until it is queried. Once queried, the register is cleared.

Mode	All
Remote Command	:STATus:QUEStionable:FREQuency[:EVENT]?
Example	STAT:QUES:FREQ?
Preset	0
Status Bits/OPC dependencies	Sequential command
Initial S/W Revision	Prior to A.02.00

Questionable Frequency Negative Transition

This command determines which bits in the Questionable Frequency Condition register will set the corresponding bit in the Questionable Frequency Event register when the condition register bit has a negative transition (1 to 0). The variable <integer> is the sum of the decimal values of the bits that you want to enable.

Mode	All
Remote Command	:STATus:QUEStionable:FREQuency:NTRansition <integer> :STATus:QUEStionable:FREQuency:NTRansition?
Example	STAT:QUES:FREQ:NTR 2 Frequency Reference 'regained lock' will be reported to the Frequency Summary of the Status Questionable register.
Preset	0
Min	0
Max	32767
Status Bits/OPC dependencies	Sequential command
Initial S/W Revision	Prior to A.02.00

Questionable Frequency Positive Transition

This command determines which bits in the Questionable Frequency Condition register will set the corresponding bit in the Questionable Frequency Event register when the condition register bit has a positive transition (0 to 1). The variable <integer> is the sum of the decimal values of the bits that you want to enable.

Mode	All
------	-----

Remote Command	:STATus:QUESTionable:FREQuency:PTRansition <integer> :STATus:QUESTionable:FREQuency:PTRansition?
Example	STAT:QUES:FREQ:PTR 2 Frequency Reference 'became unlocked' will be reported to the Frequency Summary of the Status Questionable register.
Preset	32767
Min	0
Max	32767
Status Bits/OPC dependencies	Sequential command
Initial S/W Revision	Prior to A.02.00

Questionable Integrity Register

"Questionable Integrity Condition " on page 83

"Questionable Integrity Enable " on page 83

"Questionable Integrity Event Query " on page 84

"Questionable Integrity Negative Transition " on page 84

"Questionable Integrity Positive Transition " on page 85

Questionable Integrity Condition

This query returns the decimal value of the sum of the bits in the Questionable Integrity Condition register.

NOTE

The data in this register is continuously updated and reflects the current conditions.

Mode	All
Remote Command	:STATus:QUESTionable:INTEgrity:CONDition?
Example	STAT:QUES:INT:COND?
Preset	0
Status Bits/OPC dependencies	Sequential command
Initial S/W Revision	Prior to A.02.00

Questionable Integrity Enable

This command determines which bits in the Questionable Integrity Condition Register will set bits in the Questionable Integrity Event register, which also sets the Integrity Summary bit (bit 9) in the Questionable Register. The variable <integer> is the sum of the decimal values of the bits you want to enable.

Mode	All
------	-----

Remote Command	:STATus:QUEStionable:INTEgrity:ENABle <integer> :STATus:QUEStionable:INTEgrity:ENABle?
Example	STAT:QUES:INT:ENAB 8 Measurement Uncalibrated Summary will be reported to the Integrity Summary of the Status Questionable register.
Preset	32767
Min	0
Max	32767
Status Bits/OPC dependencies	Sequential command
Initial S/W Revision	Prior to A.02.00

Questionable Integrity Event Query

This query returns the decimal value of the sum of the bits in the Questionable Integrity Event register.

NOTE

The register requires that the associated PTR or NTR filters be set before a condition register bit can set a bit in the event register. The data in this register is latched until it is queried. Once queried, the register is cleared.

Mode	All
Remote Command	:STATus:QUEStionable:INTEgrity[:EVENT]?
Example	STAT:QUES:INT?
Preset	0
Status Bits/OPC dependencies	Sequential command
Initial S/W Revision	Prior to A.02.00

Questionable Integrity Negative Transition

This command determines which bits in the Questionable Integrity Condition register will set the corresponding bit in the Questionable Integrity Event register when the condition register bit has a negative transition (1 to 0)

The variable <integer> is the sum of the decimal values of the bits that you want to enable.

Mode	All
Remote Command	:STATus:QUEStionable:INTEgrity:NTRansition <integer> :STATus:QUEStionable:INTEgrity:NTRansition?
Example	STAT:QUES:INT:NTR 8 Measurement 'regained calibration' Summary will be reported to the Integrity Summary of the Status Questionable register.
Preset	0

Min	0
Max	32767
Status Bits/OPC dependencies	Sequential command
Initial S/W Revision	Prior to A.02.00

Questionable Integrity Positive Transition

This command determines which bits in the Questionable Integrity Condition register will set the corresponding bit in the Questionable Integrity Event register when the condition register bit has a positive transition (0 to 1). The variable <integer> is the sum of the decimal values of the bits that you want to enable.

Mode	All
Remote Command	:STATus:QUEStionable:INTEgrity:PTRansition <integer> :STATus:QUEStionable:INTEgrity:PTRansition?
Example	STAT:QUES:INT:PTR 8 Measurement 'became uncalibrated' Summary will be reported to the Integrity Summary of the Status Questionable register.
Preset	32767
Min	0
Max	32767
Status Bits/OPC dependencies	Sequential command
Initial S/W Revision	Prior to A.02.00

Questionable Integrity Signal Register

- Questionable Integrity Signal Condition
- Questionable Integrity Signal Enable
- Questionable Integrity Signal Event Query
- Questionable Integrity Signal Negative Transition
- Questionable Integrity Signal Positive Transition

Questionable Integrity Uncalibrated Register

- Questionable Integrity Uncalibrated Condition
- Questionable Integrity Uncalibrated Enable
- Questionable Integrity Uncalibrated Event Query
- Questionable Integrity Uncalibrated Negative Transition

Questionable Integrity Uncalibrated Positive Transition

Questionable Power Register

"Questionable Power Condition " on page 86

"Questionable Power Enable " on page 86

"Questionable Power Event Query " on page 87

"Questionable Power Negative Transition " on page 87

"Questionable Power Positive Transition " on page 87

Questionable Power Condition

This query returns the decimal value of the sum of the bits in the Questionable Power Condition register.

NOTE

The data in this register is continuously updated and reflects the current conditions.

Mode	All
Remote Command	:STATus:QUEStionable:POWer:CONDition?
Example	STAT:QUES:POW:COND?
Preset	0
Status Bits/OPC dependencies	Sequential command
Initial S/W Revision	Prior to A.02.00

Questionable Power Enable

This command determines which bits in the Questionable Power Condition Register will set bits in the Questionable Power Event register, which also sets the Power Summary bit (bit 3) in the Questionable Register. The variable <integer> is the sum of the decimal values of the bits you want to enable.

Mode	All
Remote Command	:STATus:QUEStionable:POWer:ENABle <integer> :STATus:QUEStionable:POWer:ENABle?
Example	STAT:QUES:POW:ENAB 32 50 MHz Input Pwr too High for Cal will be reported to the Power Summary of the Status Questionable register.
Preset	32767
Min	0
Max	32767
Status Bits/OPC dependencies	Sequential command
Initial S/W Revision	Prior to A.02.00

Questionable Power Event Query

This query returns the decimal value of the sum of the bits in the Questionable Power Event register.

NOTE

The register requires that the associated PTR or NTR filters be set before a condition register bit can set a bit in the event register. The data in this register is latched until it is queried. Once queried, the register is cleared.

Mode	All
Remote Command	:STATus:QUEStionable:POWer[:EVENT]?
Example	STAT:QUES:POW?
Preset	0
Status Bits/OPC dependencies	Sequential command
Initial S/W Revision	Prior to A.02.00

Questionable Power Negative Transition

This command determines which bits in the Questionable Power Condition register will set the corresponding bit in the Questionable Power Event register when the condition register bit has a negative transition (1 to 0). The variable <integer> is the sum of the decimal values of the bits that you want to enable.

Mode	All
Remote Command	:STATus:QUEStionable:POWer:NTRansition <integer> :STATus:QUEStionable:POWer:NTRansition?
Example	STAT:QUES:POW:NTR 32 50 MHz Input Power became OK for Cal will be reported to the Power Summary of the Status Questionable register.
Preset	0
Min	0
Max	32767
Status Bits/OPC dependencies	Sequential command
Initial S/W Revision	Prior to A.02.00

Questionable Power Positive Transition

This command determines which bits in the Questionable Power Condition register will set the corresponding bit in the Questionable Power Event register when the condition register bit has a positive transition (0 to 1). The variable <integer> is the sum of the decimal values of the bits that you want to enable.

Mode	All
------	-----

Remote Command	:STATus:QUESTionable:POWer:PTRansition <integer> :STATus:QUESTionable:POWer:PTRansition?>
Example	STAT:QUES:POW:PTR 32 50 MHz Input Power became too high for Cal will be reported to the Power Summary of the Status Questionable register.
Preset	32767
Min	0
Max	32767
Status Bits/OPC dependencies	Sequential command
Initial S/W Revision	Prior to A.02.00

Questionable Temperature Register

- "Questionable Temperature Condition" on page 88
- "Questionable Temperature Enable" on page 88
- "Questionable Temperature Event Query" on page 89
- "Questionable Temperature Negative Transition" on page 89
- "Questionable Temperature Positive Transition" on page 90

Questionable Temperature Condition

This query returns the decimal value of the sum of the bits in the Questionable Temperature Condition register.

NOTE The data in this register is continuously updated and reflects the current conditions.

Mode	All
Remote Command	:STATus:QUESTionable:TEMPerature:CONDition?
Example	STAT:QUES:TEMP:COND?
Preset	0
Status Bits/OPC dependencies	Sequential command
Initial S/W Revision	Prior to A.02.00

Questionable Temperature Enable

This command determines which bits in the Questionable Temperature Condition Register will set bits in the Questionable Temperature Event register, which also sets the Temperature Summary bit (bit 4) in the Questionable Register. The variable <integer> is the sum of the decimal values of the bits you want to enable.

Mode	All
Remote Command	:STATus:QUESTionable:TEMPerature:ENABle <integer> :STATus:QUESTionable:TEMPerature:ENABle?
Example	STAT:QUES:TEMP:ENAB 1 Reference Oscillator Oven Cold will be reported to the Temperature Summary of the Status Questionable register.
Preset	32767
Min	0
Max	32767
Status Bits/OPC dependencies	Sequential command
Initial S/W Revision	Prior to A.02.00

Questionable Temperature Event Query

This query returns the decimal value of the sum of the bits in the Questionable Temperature Event register.

NOTE

The register requires that the associated PTR or NTR filters be set before a condition register bit can set a bit in the event register. The data in this register is latched until it is queried. Once queried, the register is cleared

Mode	All
Remote Command	:STATus:QUESTionable:TEMPerature[:EVENT]?
Example	STAT:QUES:TEMP?
Preset	0
Status Bits/OPC dependencies	Sequential command
Initial S/W Revision	Prior to A.02.00

Questionable Temperature Negative Transition

This command determines which bits in the Questionable Temperature Condition register will set the corresponding bit in the Questionable Temperature Event register when the condition register bit has a negative transition (1 to 0). The variable <integer> is the sum of the decimal values of the bits that you want to enable.

Mode	All
Remote Command	:STATus:QUESTionable:TEMPerature:NTRansition <integer> :STATus:QUESTionable:TEMPerature:NTRansition?
Example	STAT:QUES:TEMP:NTR 1 Reference Oscillator Oven not cold will be reported to the Temperature Summary of the Status Questionable register.
Preset	0

Min	0
Max	32767
Status Bits/OPC dependencies	Sequential command
Initial S/W Revision	Prior to A.02.00

Questionable Temperature Positive Transition

This command determines which bits in the Questionable Temperature Condition register will set the corresponding bit in the Questionable Temperature Event register when the condition register bit has a positive transition (0 to 1). The variable <integer> is the sum of the decimal values of the bits that you want to enable.

Mode	All
Remote Command	:STATus:QUESTionable:TEMPerature:PTRansition <integer> :STATus:QUESTionable:TEMPerature:PTRansition?
Example	STAT:QUES:TEMP:PTR 1 Reference Oscillator Oven became cold will be reported to the Temperature Summary of the Status Questionable register.
Preset	32767
Min	0
Max	32767
Status Bits/OPC dependencies	Sequential command
Initial S/W Revision	Prior to A.02.00

Common Commands

- "All (Daily use)" on page 188
- "Clear Status " on page 93
- "Standard Event Status Enable " on page 94
- "Standard Event Status Register Query " on page 94
- "Identification Query " on page 95
- "Operation Complete " on page 95
- "Query Instrument Options " on page 96
- "Recall Instrument State " on page 96
- "*RST (Remote Command Only)" on page 97
- "Save Instrument State " on page 97
- "Service Request Enable " on page 98
- "Status Byte Query " on page 98
- "Trigger " on page 98
- "Self Test Query " on page 99
- "Wait-to-Continue " on page 99

All (Daily use)

Immediately executes an alignment of all subsystems which includes both the source and the analyzer in the TRX module. The "All" alignment is sufficient to maintain specified performance, provided that (1) the TRX's internal temperature has not drifted more than +/-5 degree C since the previous alignment, and (2) no more than 8 hours have elapsed since the previous "All" alignment., and (3) no more than 1 week has elapsed since these three alignments have all been run: IF, RF, and Source, and (4) a 45 minute warm-up period between power-up of the TRX and invoking the "All" alignment. The instrument stops any measurement currently underway, performs the alignment, then restarts the measurement from the beginning (similar to pressing the **Restart** key).

If an interfering user signal is present at the RF Input, the alignment is performed on all subsystems except the RF. After completion, the Error Condition message "Align skipped: 50 MHz interference" or "Align skipped: 4.8 GHz interference" is generated. In addition the Error Condition message "Align Now, RF required" is generated, and bits 11 and 12 are set in the Status Questionable Calibration register.

The query form of the remote commands (:CALibration[:ALL]? or *CAL?) invokes the alignment of all subsystems and returns a success or failure value. An interfering user signal is not grounds for failure; if the alignment was able to succeed on all portions but unable to align the RF because of an interfering signal, the resultant will be the success value.

Successful completion of **Align Now, All** will clear the "Align Now, All required" Error Condition, and clear bit 14 in the Status Questionable Calibration register. It will also begin the elapsed time counter for Last Align Now, All Time, and capture the Last Align Now, All Temperature.

If the Align RF subsystem succeeded in aligning (no interfering signal present), the elapsed time counter begins for Last Align Now, RF Time, and the temperature is captured for the Last Align Now, RF Temperature. In addition the Error Conditions “Align skipped: 50 MHz interference” and “Align skipped: 4.8 GHz interference” are cleared, the Error Condition “Align Now, RF required” is cleared, and bits 11 and 12 are cleared in the Status Questionable Calibration register

Align Now, All can be interrupted by pressing the Cancel (ESC) front-panel key or remotely with Device Clear followed by the :ABORt SCPI command. When this occurs the Error Condition message “Align Now, All required” is generated, and bit 14 is set in the Status Questionable Condition register. This is because new alignment data may be employed for an individual subsystem, but not a cohesive set of data for all subsystems.

In many cases, you might find it more convenient to change alignments to Normal, instead of executing Align Now, All. When the Auto Align process transitions to Normal, the analyzer will immediately start to update only the alignments that have expired, thus efficiently restoring the alignment process.

NOTE In EXF, Source ARB play will be turned off and the source states will not be restored after **Align Now, All**.

Key Path	System, Alignments, Align Now
Mode	All
Remote Command	:CALibration[:ALL] :CALibration[:ALL]?
Example	:CAL
Notes	:CALibration[:ALL]? returns 0 if successful :CALibration[:ALL]? returns 1 if failed :CALibration[:ALL]? is the same as *CAL? While Align Now, All is performing the alignment, bit 0 in the Status Operation register is set. Completion, or termination, will clear bit 0 in the Status Operation register. This command is sequential; it must complete before further SCPI commands are processed. Interrupting the alignment from remote is accomplished by invoking Device Clear followed by the :ABORt command. Successful completion will clear bit 14 in the Status Questionable Calibration register. An interfering user signal is not grounds for failure of Align Now, All. However, bits 11 and 12 are set in the Status Questionable Calibration register to indicate Align Now, RF is required. An interfering user supplied signal will result in the instrument requiring an Align Now, RF with the interfering signal removed.
Couplings	Initializes the time for the Last Align Now, All Time. Records the temperature for the Last Align Now, All Temperature. If Align RF component succeeded, initializes the time for the Last Align Now, RF Time. If Align RF component succeeded, records the temperature for the Last Align Now, RF Temperature.
Status Bits/OPC dependencies	Bits 11, 12, or 14 may be set in the Status Questionable Calibration register.
Initial S/W Revision	Prior to A.02.00

Mode	All
Remote Command	*CAL?
Example	*CAL?
Notes	*CAL? returns 0 if successful *CAL? returns 1 if failed :CALibration[:ALL]? is the same as *CAL? See additional remarks described with :CALibration[:ALL]? Everything about :CALibration[:ALL]? is synonymous with *CAL? including all conditions, status register bits, and couplings
Initial S/W Revision	Prior to A.02.00

Mode	All
Remote Command	:CALibration[:ALL]:NPENding
Example	CAL:NPEN
Notes	:CALibration[:ALL]:NPENding is the same as :CALibration[:ALL] including all conditions, status register bits, except this scpi command does not BLOCK the scpi session, so the user should use status register bits to query if the calibration is successfully completed or not. Typical usage is: 1) :CALibration:ALL:NPENding (Start a calibration) 2) :STATus:OPERation:CONDition? (Check if the calibration is completed or not, If bit 0 is set, then the system is doing calibration, the user should repeat this scpi query until the bit is cleared) 3) :STATus:QUESTionable:CALibration:CONDition? (Check if there are any errors/failures in previous calibration procedure
Initial S/W Revision	X.14.20

Clear Status

Clears the status byte register. It does this by emptying the error queue and clearing all bits in all of the event registers. The status byte register summarizes the states of the other registers. It is also responsible for generating service requests.

Key Path	No equivalent key. Related key System, Show Errors, Clear Error Queue
Remote Command	*CLS
Example	*CLS Clears the error queue and the Status Byte Register.
Notes	For related commands, see the SYSTem:ERRor[:NEXT]? command. See also the STATus:PRESet command and all commands in the STATus subsystem.
Status Bits/OPC dependencies	Resets all bits in all event registers to 0, which resets all the status byte register bits to 0 also.
Backwards Compatibility Notes	In general the status bits used in the X-Series status system will be backwards compatible with ESA and PSA. However, note that all conditions will generate events that go into the event log, and some

	will also generate status bits.
Initial S/W Revision	Prior to A.02.00

Standard Event Status Enable

Selects the desired bits from the standard event status enable register. This register monitors I/O errors and synchronization conditions such as operation complete, request control, query error, device dependent error, status execution error, command error, and power on. The selected bits are OR'd to become a summary bit (bit 5) in the byte register which can be queried.

The query returns the state of the standard event status enable register.

Key Path	No equivalent key. Related key System, Show Errors, Clear Error Queue
Remote Command	*ESE <integer> *ESE?
Example	*ESE 36 Enables the Standard Event Status Register to monitor query and command errors (bits 2 and 5). *ESE? Returns a 36 indicating that the query and command status bits are enabled.
Notes	For related commands, see the STATus subsystem and SYSTem:ERRor[:NEXT]? commands.
Preset	255
State Saved	Not saved in state.
Min	0
Max	255
Status Bits/OPC dependencies	Event Enable Register of the Standard Event Status Register.
Initial S/W Revision	Prior to A.02.00

Standard Event Status Register Query

Queries and clears the standard event status event register. (This is a destructive read.) The value returned is a hexadecimal number that reflects the current state (0/1) of all the bits in the register.

Remote Command	*ESR?
Example	*ESR? Returns a 1 if there is either a query or command error, otherwise it returns a zero.
Notes	For related commands, see the STATus subsystem commands.
Preset	0
Min	0
Max	255
Status Bits/OPC dependencies	Standard Event Status Register (bits 0 - 7).
Initial S/W Revision	Prior to A.02.00

Identification Query

Returns a string of instrument identification information. The string will contain the model number, serial number, and firmware revision.

The response is organized into four fields separated by commas. The field definitions are as follows:

- Manufacturer
- Model
- Serial number
- Firmware version

Key Path	No equivalent key. See related key System, Show System.
Remote Command	*IDN?
Example	*IDN? Returns instrument identification information, such as: Keysight Technologies, E6650A, US01020004, E.14.50
Initial S/W Revision	Prior to A.02.00
Modified at S/W Revision	x.14.50

Operation Complete

The *OPC command sets bit 0 in the standard event status register (SER) to “1” when pending operations have finished, that is when all overlapped commands are complete. It does not hold off subsequent operations. You can determine when the overlapped commands have completed either by polling the OPC bit in SER, or by setting up the status system such that a service request (SRQ) is asserted when the OPC bit is set.

The *OPC? query returns a “1” after all the current overlapped commands are complete. So it holds off subsequent commands until the “1” is returned, then the program continues. This query can be used to synchronize events of other instruments on the external bus.

Remote Command	*OPC *OPC?
Example	INIT:CONT 0 Selects single sweeping. INIT:IMM Initiates a sweep. *OPC? Holds off any further commands until the sweep is complete.
Status Bits/OPC dependencies	Not global to all remote ports or front panel. *OPC only considers operation that was initiated on the same port as the *OPC command was issued from. *OPC is an overlapped command, but *OPC? is sequential.
Backwards Compatibility Notes	1. The ESA/PSA/VSA products do not meet all the requirements for the *OPC command specified by IEEE 488.2. This is corrected for X-Series. This will sometimes cause behavior that is not backward compatible, but it will work as customers expect.

-
2. Commands such as, *OPC/*OPC?/*WAI/*RST used to be global. They considered front panel operation in conjunction with the GPIB functionality. Now they are evaluated on a per channel basis. That is, the various rear panel remote ports and the front panel i/o are all considered separately. Only the functionality initiated on the port where the *OPC was sent, is considered for its operation.
 3. *OPC used to hold off until the operation bits were cleared. Now it holds off until all overlapping commands are completed. Also, earlier instruments did not wait for completion of all processes, only the ones identified here (in the STATus:OPERation register):
 - Calibrating: monitored by PSA, ESA, VSA (E4406A)
 - Sweeping: monitored by PSA, ESA, VSA (E4406A)
 - Waiting for Trigger: monitored by PSA, ESA, VSA (E4406A)
 - Measuring: monitored by PSA and ESA (but not in all Modes).
 - Paused: monitored by VSA (E4406A).
 - Printing: monitored by VSA (E4406A).
 - Mass memory busy: monitored by VSA (E4406A).
-

Initial S/W Revision	Prior to A.02.00
----------------------	------------------

Query Instrument Options

Returns a string of all the installed instrument options. It is a comma separated list with quotes, such as: "503,P03,PFR".

To be IEEE compliant, this command should return an arbitrary ascii variable that would not begin and end with quotes. But the quotes are needed to be backward compatible with previous SA products and software. So, the actual implementation will use arbitrary ascii. But quotes will be sent as the first and last ascii characters that are sent with the comma-separated option list.

Remote Command	*OPT?
-----------------------	-------

Initial S/W Revision	Prior to A.02.00
----------------------	------------------

Recall Instrument State

This command recalls the instrument state from the specified instrument memory register.

- If the state being loaded has a newer firmware revision than the revision of the instrument, no state is recalled and an error is reported
- If the state being loaded has an equal firmware revision than the revision of the instrument, the state will be loaded.
- If the state being loaded has an older firmware revision than the revision of the instrument, the instrument will only load the parts of the state that apply to the older revision.

Remote Command	*RCL <register #>
-----------------------	-------------------

Example	*RCL 7 Recalls the instrument state that is currently stored in register 7.
----------------	---

Notes	Registers 0 through 6 are accessible from the front panel in menu keys for Recall Registers.
Min	0
Max	127
Status Bits/OPC dependencies	The command is sequential.
Initial S/W Revision	Prior to A.02.00

*RST (Remote Command Only)

*RST is equivalent to :SYST:PRES::INIT:CONT OFF, which is a Mode Preset in the Single measurement state. This remote command is preferred over Mode Preset remote command - :SYST:PRES, as optimal remote programming occurs with the instrument in the single measurement state.

Remote Command	*RST
Example	*RST
Notes	Sequential Clears all pending OPC bits and the Status Byte is set to 0.
Couplings	A *RST will cause the currently running measurement to be aborted and cause the default measurement to be active. *RST gets the mode to a consistent state with all of the default couplings set.
Backwards Compatibility Notes	In legacy analyzers *RST did not set the analyzer to Single, but in the X-Series it does, for compliance with the IEEE 488.2 specification. In the X-Series, *RST does not do a *CLS (clear the status bits and the error queue). In legacy analyzers, *RST used to do the equivalent of SYSTem:PRESet, *CLS and INITiate:CONTinuous OFF. But to be 488.2 compliant, *RST in the X-Series does not do a *CLS.
Initial S/W Revision	Prior to A.02.00

Save Instrument State

This command saves the current instrument state and mode to the specified instrument memory register.

Remote Command	*SAV <register #>
Example	*SAV 9 Saves the instrument state in register 9.
Notes	Registers 0 through 6 are accessible from the front panel in menu keys for Save Registers.
Min	0
Max	127
Status Bits/OPC dependencies	The command is sequential.
Initial S/W Revision	Prior to A.02.00

Service Request Enable

This command enables the desired bits of the service request enable register.

The query returns the value of the register, indicating which bits are currently enabled.

Remote Command	*SRE <integer> *SRE?
Example	*SRE 22 Enables bits 1, 2, and 4 in the service request enable register.
Notes	For related commands, see the STATus subsystem and SYSTem:ERRor[:NEXT]? commands.
Preset	0
Min	0
Max	255
Status Bits/OPC dependencies	Service Request Enable Register (all bits, 0 – 7).
Initial S/W Revision	Prior to A.02.00

Status Byte Query

Returns the value of the status byte register without erasing its contents.

Remote Command	*STB?
Example	*STB? Returns a decimal value for the bits in the status byte register. For example, if a 16 is returned, it indicates that bit 5 is set and one of the conditions monitored in the standard event status register is set.
Notes	See related command *CLS.
Status Bits/OPC dependencies	Status Byte Register (all bits, 0 – 7).
Initial S/W Revision	Prior to A.02.00

Trigger

This command triggers the instrument. Use the :TRIGger[:SEQUence]:SOURce command to select the trigger source.

Key Path	No equivalent key. See related keys Single and Restart.
Remote Command	*TRG
Example	*TRG Triggers the instrument to take a sweep or start a measurement, depending on the current instrument settings.
Notes	See related command :INITiate:IMMEDIATE.
Initial S/W Revision	Prior to A.02.00

Self Test Query

This query performs the internal self-test routines and returns a number indicating the success of the testing. A zero is returned if the test is successful, 1 if it fails.

Remote Command	*TST?
Example	*TST? Runs the self-test routines and returns 0=passed, 1=some part failed.
Initial S/W Revision	Prior to A.02.00

Wait-to-Continue

This command causes the instrument to wait until all overlapped commands are completed before executing any additional commands. There is no query form for the command.

Remote Command	*WAI
Example	INIT:CONT OFF; INIT;*WAI Sets the instrument to single sweep. Starts a sweep and waits for its completion.
Status Bits/OPC dependencies	Not global to all remote ports or front panel. *OPC only considers operation that was initiated on the same port as the *OPC command was issued from.
Initial S/W Revision	Prior to A.02.00

(Undefined variable: Primary.ProductName)
IQ Analyzer Mode Reference

4 Input/Output Functions

Input/Output

The Input/Output features are common across multiple Modes and Measurements. These common features are described in this section. See the Measurement description for information on features that are unique.

The Input/Output key accesses the keys that control the Input/Output parameters of the instrument. In general, these are functions associated with external connections to the analyzer, either to the inputs or the outputs. Since these connections tend to be fairly stable within a given setup, in general, the input/output settings do not change when you Preset the analyzer.

Other functions related to the input/output connections, but which tend to change on a measurement by measurement basis, can be found under the **Trigger** and **AMPTDY Scale** keys. In addition, some of the digital I/O bus configurations can be found under the **System** key.

NOTE

The functions in the Input/Output menu are "global" (common) to all Modes (applications). But individual Input/Output functions only appear in a Mode if they apply to that Mode. Functions that apply to a Mode but not to all measurements in the Mode may be grayed-out in some measurements.

["Input/Output variables - Preset behavior" on page 103](#)

The Input Port selection is the first menu under the **Input/Output** key:

Key Path	Front-panel key
Remote Command	<code>[:SENSe] :FEED RF AIQ EMIXer</code> <code>[:SENSe] :FEED?</code>
Example	<code>:FEED RF</code> <code>:FEED?</code>
Couplings	The <code>[:SENSe] :FEED RF</code> command turns the calibrator OFF
Preset	This setting is unaffected by a Preset or power cycle. It survives a Mode Preset and mode changes. It is set to RF on a "Restore Input/Output Defaults" or "Restore System Defaults->All"
State Saved	Saved in instrument state
Backwards Compatibility SCPI	<code>[:SENSe] :FEED AREFERENCE</code> In the PSA the calibrator was one of the inputs and selected using the AREF parameter to the same <code>:FEED</code> command that switched the inputs. In the X-Series it is controlled in a separate menu and overrides the input selection. For code compatibility the <code>[:SENSe] :FEED AREFERENCE</code> command is provided, and is aliased to <code>[:SENSe] :FEED :AREF REF50</code> , which causes the input to be switched to the 50 MHz calibrator. The <code>[:SENSe] :FEED RF</code> command switches the input back to the RF port and turns the calibrator OFF, thus providing full compatibility with the PSA calibrator function. Note that after sending this, the query <code>[:SENSe] :FEED?</code> will NOT return "AREF" but instead the currently selected input.
Backwards Compatibility SCPI	<code>[:SENSe] :FEED IQ IONLy QONLy</code> <code>[:SENSe] :FEED?</code> The parameters <code>IQ IONLy QONLy</code> are supported for backwards compatibility with the E44406A. <code>[:SENSe] :FEED IQ</code> aliases to <code>[:SENSe] :FEED :IQ :TYPE IQ</code> <code>[:SENSe] :FEED IONLy</code> aliases to <code>[:SENSe] :FEED :IQ :TYPE IONLy</code>

	<p>[;SENSe]:FEED QONLY aliases to [;SENSe]:FEED:IQ:TYPE QONLY</p> <p>The query [;SENSe]:FEED? will always returns AIQ whatever the type of legacy parameters IQ IONLY QONLY has been used.</p>
Backwards Compatibility Notes	<p>Most of the settings in the X-Series Input/Output system, including External Gain, Amplitude Corrections settings and data, etc., are shared by all modes and are not changed by a mode switch. Furthermore, most variables in the Input/Output system key are not affected by Mode Preset. Both of these behaviors represent a departure from legacy behavior.</p> <p>In the X-Series. Input/Output settings are reset by using the "Restore Input/Output Defaults" function. They can also be reset to their default values through the System->Restore System Defaults-> In/Out Config key or through the System ->Restore System Defaults -> All key (and corresponding SCPI).</p> <p>While this matches most use cases better, it does create some code compatibility issues. For example, Amplitude Corrections are no longer turned off by a Mode Preset, but instead by using the "Restore Input/Output Defaults" key/SCPI.</p> <p>Although Input/Output settings are not part of each Mode's State, they are saved in the Save State files, so that all of the instrument settings can be recalled with Recall State, as in legacy instruments.</p>
Initial S/W Revision	Prior to A.02.00
Remote Command	<p>:INPut:MIXer EXTernal INTernal</p> <p>:INPut:MIXer?</p>
Example	<p>INP:MIX INT</p> <p>INP:MIX?</p>
Notes	<p>In legacy analyzers you choose between the Internal mixer or an External Mixer. In the X-Series, the External Mixer is one of the choices for the Input and is selected using the FEED command (:SENSe:FEED EXTMIxer).</p> <p>For compatibility, the INPut:MIXer EXTernal INTernal legacy command is mapped as follows:</p> <ol style="list-style-type: none"> 1. When INPut:MIXer EXTernal is received, SENSe:FEED EMIXer is executed. 2. When INPut:MIXer INTernal is received, SENSe:FEED RF is executed. 3. When INPut:MIXer? is received, the response will be INT if any input other than the external mixer is selected and EXT if the external mixer is selected
Preset	INT
Backwards Compatibility Notes	<p>PSA supports the following SCPI Command :</p> <p>:INPut:MIXer:TYPE PRESelected UNPReselect</p> <p>:INPut:MIXer:TYPE?</p> <p>PXA does not support the :INPut:MIXer:TYPE command.</p>
Initial S/W Revision	A.08.01

Input/Output variables - Preset behavior

Virtually all the input/output settings are NOT a part of mode preset. They can be set to their default value

by one of the three ways:

- by using the Restore Input/Output Defaults key on the first page of the input/output menu,
- by using the System->Restore System Defaults->Input/Output Settings or,
- by using the System -> Restore System Defaults->All. Also, they survive a Preset and a Power cycle.

A very few of the Input/Output settings do respond to a Mode Preset; for example, if the Calibrator is on it turns off on a Preset, and if DC coupling is in effect it switches to AC on a Preset. These exceptions are made in the interest of reliability and usability, which overrides the need for absolute consistency. Exceptions are noted in the SCPI table for the excepted functions.

RF Input

Selects the front-panel RF input port to be the analyzer signal input. If RF is already selected, pressing this key accesses the RF input setup functions.

Key Path	Input/Output
Example	[:SENSe]:FEED RF
Couplings	The act of connecting the U7227A USB Preamplifier to one of the analyzer's USB ports will cause the Input to automatically switch to the RF Input. If the RF Calibrator is on, it is turned off. Subsequently disconnecting the USB Preamp from USB does not change the Input selection nor restore the previous selection.
Readback	The RF input port, RF coupling, and current input impedance settings appear on this key as: "XX, YY, ZZ" where XX is RF, RF2, RFIO1, RFIO2, depending on what input is selected (only appears on analyzers with multiple RF inputs) YY is AC or DC ZZ is 50Ω or 75Ω
Initial S/W Revision	Prior to A.02.00
Modified at S/W Revision	A.14.00

Input Z Correction

Sets the input impedance for unit conversions. This affects the results when the y-axis unit is voltage or current units (dBmV, dBμV, dBμA, V, A), but not when it is power units (dBm, W). The impedance you select is for computational purposes only, since the actual impedance is set by internal hardware to 50 ohms. Setting the computational input impedance to 75 ohms is useful when using a 75 ohm to 50 ohm adapter to measure a 75 ohm device on an analyzer with a 50 ohm input impedance.

There are a variety of ways to make 50 to 75 ohm transitions, such as impedance transformers or minimum loss pads. The choice of the solution that is best for your measurement situation requires balancing the amount of loss that you can tolerate with the amount of measurement frequency range that you need. If you are using one of these pads/adaptors with the **Input Z Corr** function, you might also want to use the **Ext Gain** key. This function is used to set a correction value to compensate for the gain (loss) through your pad. This correction factor is applied to the displayed measurement values.

Key Path	Input/Output, RF Input
Remote Command	<code>[:SENSe] :CORRection:IMPedance [:INPut] [:MAGNitude] 50 75</code> <code>[:SENSe] :CORRection:IMPedance [:INPut] [:MAGNitude] ?</code>
Example	CORR:IMP 75 sets the input impedance correction to 75 ohms. CORR:IMP?
Preset	This is unaffected by a Preset but is set to 50 ohms on a "Restore Input/Output Defaults" or "Restore System Defaults->All" Some instruments/options may have 75 ohms available.
State Saved	Saved in instrument state
Readback	50 Ω or 75 Ω. Current setting reads back to the RF key.
Initial S/W Revision	Prior to A.02.00

RF Input Port

Specifies the RF input port used. The RF Input Port key only appears on units with multiple inputs, and lets you switch between the two inputs.

Switching from the RF input port to one of the RFIO ports, on units that have them, changes the receiver performance of the instrument.

Key Path	Input/Output, RF Input
Remote Command	<code>[:SENSe] :FEED:RF:PORT [:INPut] RFIN RFIN2 RFIO1 RFIO2 RFIO3 RFIO4</code> <code>[:SENSe] :FEED:RF:PORT [:INPut] ?</code>
Example	:FEED:RF:PORT RFIN
Dependencies	This key only appears in models that support multiple inputs. If the SCPI command is sent with unsupported parameters in any other model, an error is generated, -221.1900, "Settings conflict;option not installed" When any input is selected in a measurement that does not support it, the "No result; Meas invalid with this input" error condition occurs, and the measurement returns invalid data when queried.
Preset	This is unaffected by Mode Preset but is set to RF on a "Restore Input/Output Defaults" or "Restore System Defaults -> All"
State Saved	Saved in instrument state
Readback	The current RF Input Port selected is read back to this key
Backwards Compatibility SCPI	<code>INPut<1 2>:TYPE INPUT1 INPUT2</code> <code>INPut<1 2>:TYPE?</code> Included for R&S ESU compatibility. In the MXE, the INPUT1 parameter is aliased to RFIN and the INPUT2 parameter is aliased to RFIN2
Initial S/W Revision	A.05.01
Modified at S/W Revision	A.14.00

RF Input

Specifies using the main RF port for the current measurement

Key Path	Input/Output, RF Input, RF Input Port
Example	:FEED:RF:PORT RFIN
Notes	If RF Input is selected as RF Input Port, you need to choose the settings in the Half Duplex Config menu to determine which port (RFIO3 or RFIO4) will be used.
ReadBack	RF Input
Initial S/W Revision	A.05.01
Modified at S/W Revision	A.14.00

RFIO1

Specifies using the RFIO 1 port for the current measurement

Key Path	Input/Output, RF Input, RF Input Port
Example	:FEED:RF:PORT RFIO1
Dependencies	RFIO1 is not available in E6607C. If Multiport Adapter is ON, Select RF Input to RFIO1, an error message is generated: “-221, Settings conflict; RFIO1 or RFIO2 Port unavailable when Multiport Adapter is ON”.
ReadBack	RFIO 1
Initial S/W Revision	A.05.01

RFIO2

Specifies using the RFIO 2 port for the current measurement

Key Path	Input/Output, RF Input, RF Input Port
Example	:FEED:RF:PORT RFIO2
Dependencies	RFIO2 is not available in E6607C. If Multiport Adapter is ON, Select RF Input to RFIO2, an error message is generated: “-221, Settings conflict; RFIO1 or RFIO2 Port unavailable when Multiport Adapter is ON”.
ReadBack	RFIO 2
Initial S/W Revision	A.05.01

External Gain

Compensates for gain or loss in the measurement system outside the spectrum analyzer. The External Gain is subtracted from the amplitude readout (or the loss is added to the amplitude readout). So, the displayed signal level represents the signal level at the output of the device-under-test, which can be the input of an external device that provides gain or loss.

Entering an External Gain value does not affect the Reference Level, therefore the trace position on screen changes, as do all of the values represented by the trace data. Thus, the values of exported trace data, queried trace data, marker amplitudes, trace data used in calculations such as N dB points, trace math, peak threshold, etc., are all affected by External Gain. Changing the External Gain, even on a trace that is not updating, will immediately change all of the above, without new data needing to be taken.

NOTE

Changing the External Gain causes the analyzer to immediately stop the current sweep and prepare to begin a new sweep. The data will not change until the trace data updates because the offset is applied to the data as it is taken. If a trace is exported with a nonzero External Gain, the exported data will contain the trace data with the offset applied.

In the Spectrum Analyzer mode, a Preamp is the common external device providing gain or loss. In a measurement application mode like GSM or W-CDMA, the gain or loss could be from a BTS (Base Transceiver Station) or an MS (Mobile Station). So in the Spectrum Analyzer mode MS and BTS would be grayed out and the only choice would be Ext Preamp. Similarly in some of the digital communications applications, Ext Preamp will be grayed out and you would have a choice of MS or BTS.

Key Path	Input/Output
Couplings	The Ext Preamp, MS, and BS keys may be grayed out depending on which measurement is currently selected. If any of the grayed out keys are pressed, or the equivalent SCPI command is sent, an advisory message is generated.
Readback	1-of-N selection [variable]
Initial S/W Revision	Prior to A.02.00

Ext Preamp

This function is similar to the reference level offset function. Both affect the displayed signal level. Ref Lvl Offset is a mathematical offset only, no analyzer configuration is affected. Ext Preamp gain is used when determining the auto-coupled value of the Attenuator. The External Gain value and the Maximum Mixer Level settings are both part of the automatic setting equation for the RF attenuation setting. (10 dB of Attenuation is added for every 10 dB of External Gain.)

Note that the Ref Lvl Offset and Maximum Mixer Level are described in the Amplitude section. They are reset by the instrument Preset. The External Preamp Gain is reset by the "Restore Input/Output Defaults" or "Restore System Defaults->All functions. . The External Gain is subtracted from the amplitude readout so that the displayed signal level represents the signal level at the output of the device-under-test, which is the input of the external device that is providing gain or loss.

["More Information" on page 108](#)

Key Path	Input/Output, External Gain
----------	-----------------------------

Remote Command	<code>[:SENSe] :CORRection:SA[:RF]:GAIN <rel_ampl></code> <code>[:SENSe] :CORRection:SA[:RF]:GAIN?</code>
Example	CORR:SA:GAIN 10 sets the Ext Gain value to 10 dB CORR:SA:GAIN -10 sets the Ext Gain value to -10 dB (that is, an attenuation of 10 dB)
Notes	Does not auto return.
Dependencies	The reference level limits are determined in part by the External Gain/Atten, Max Mixer Level, and RF Atten. This key is grayed out in Modes that do not support External Gain
Preset	This is unaffected by Preset but is set to 0 dB on a "Restore Input/Output Defaults" or "Restore System Defaults->All"
State Saved	Saved in instrument state
Min	-120 dB
Max	120 dB
Readback	Preamp Gain, <Ext Gain value> dB
Backwards Compatibility SCPI	<code>[:SENSe] :CORRection:OFFSet[:MAGNitude]</code> The legacy "Ext Preamp Gain" key is now called "Ext Gain" and the sub-menu has choices of Ext Preamp MS BTS for backwards compatibility.
Initial S/W Revision	Prior to A.02.00
Modified at S/W Revision	A.14.00

More Information

The U7227A USB Preamplifier is an accessory for the X-Series Signal Analyzer that provides gain externally, and whose gain settings are automatically loaded into the analyzer over USB whenever it is connected to one of the analyzer's USB ports.

While the USB Preamplifier is plugged into one of the analyzer's USB ports, the analyzer will consider it to be in the signal path of the RF Input and will apply the calibration data from the USB Preamp to measurements taken at the RF Input (on 2 input boxes, it will be considered to be in the signal path of RF Input 1; it is not supported for RF Input 2).

The USB Preamplifier contains its own cal data. This includes a noise trace suitable for use with NFE, for those models which support NFE. The act of connecting the Preamp to USB will cause the cal data to be downloaded from the preamp. When this happens an informational message is provided saying "Cal data loaded from USB Preamp". The analyzer will then automatically apply the calibration factors loaded from the Preamp in any measurement that supports the USB Preamp.

The External Preamp Gain setting may still be used, even though it is not required for the USB Preamp (since the USB Preamp supplies its own gain data to the analyzer which is applied automatically). Connecting the USB Preamp does not change the External Preamp Gain setting, however unless you have another gain or attenuation element in the signal path, the appropriate setting for External Preamp Gain is 0 dB.

Overload detection and reporting will apply when the USB preamplifier is connected to USB. The USB Preamplifier has its own overload detector which reports overloads to the instrument over USB. This generates an error condition, "Input Overload;USB Preamp."

If, while the USB Preamp is connected to USB, a measurement is selected that does not support the USB preamplifier, the "No result; Meas invalid with Preamp" error condition is generated.

MS

Sets an external gain/attenuation value for MS (Mobile Station) tests.

Key Path	Input/Output, External Gain
Remote Command	<code>[:SENSe]:CORRection:MS[:RF]:GAIN <rel_ampl></code> <code>[:SENSe]:CORRection:MS[:RF]:GAIN?</code>
Example	CORR:MS:GAIN 10 sets the Ext Gain value to 10 dB CORR:MS:GAIN -10 sets the Ext Gain value to -10 dB (that is, a loss of 10 dB.)
Notes	Does not auto return.
Dependencies	The reference level limits are determined in part by the External Gain, Max Mixer Level, RF Atten This key is grayed out in modes that do not support MS.
Preset	This is unaffected by a Preset but is set to 0 dB on a "Restore Input/Output Defaults" or "Restore System Defaults->All"
State Saved	Saved in instrument state.
Min	-100 dB
Max	100 dB
Readback	MS, <Ext Gain value> dB
Initial S/W Revision	Prior to A.02.00

Remote Command	<code>[:SENSe]:CORRection:MS[:RF]:LOSS <rel_ampl></code> <code>[:SENSe]:CORRection:MS[:RF]:LOSS?</code>
Example	CORR:MS:LOSS 10 sets the Ext Gain value to -10 dB, and subsequently querying :LOSS will give 10 dB CORR:MS:LOSS -10 sets the Ext Gain value to 10 dB, and subsequently querying :LOSS will give -10 dB
Notes	A positive value of <rel_ampl> in the above command means a loss and a negative value indicates a gain. Anytime :LOSS is set it sets :GAIN to the negative value of the parameter sent. Anytime :LOSS is queried it gives the negative of :GAIN
Preset	This is unaffected by a Preset but is set to 0 dB on a "Restore Input/Output Defaults" or "Restore System Defaults->All"
Min	100 dB
Max	-100 dB
Initial S/W Revision	Prior to A.02.00

BTS

Sets an external attenuation value for BTS (Base Transceiver Station) tests.

Key Path	Input/Output, External Gain
Remote Command	<code>[:SENSe]:CORRection:BTS[:RF]:GAIN <rel_ampl></code> <code>[:SENSe]:CORRection:BTS[:RF]:GAIN?</code>
Example	CORR:BTS:GAIN 10 sets the Ext Gain value to 10 dB CORR:BTS:GAIN -10 sets the Ext Gain value to -10 dB (that is, a loss of 10 dB.)
Notes	Does not auto return.
Dependencies	The reference level limits are determined in part by the External Gain, Max Mixer Level, RF Atten This key is grayed out in modes that do not support BTS.
Preset	This is unaffected by a Preset but is set to 0 dB on a "Restore Input/Output Defaults" or "Restore System Defaults->All"
State Saved	Saved in instrument state.
Min	-100 dB
Max	100 dB
Readback	BTS, <Ext Gain value> dB
Initial S/W Revision	Prior to A.02.00

Remote Command	<code>[:SENSe]:CORRection:BTS[:RF]:LOSS <rel_ampl></code> <code>[:SENSe]:CORRection:BTS[:RF]:LOSS?</code>
Example	CORR:BTS:LOSS 10 sets the Ext Gain value to -10 dB, and subsequently querying :LOSS will give 10 dB CORR:BTS:LOSS -10 sets the Ext Gain value to 10 dB, and subsequently querying :LOSS will give -10 dB
Notes	A positive value of <rel_ampl> in the above command means a loss and a negative value indicates a gain. Anytime :LOSS is set it sets :GAIN to the negative value of the parameter sent. Anytime :LOSS is queried it gives the negative of :GAIN
Preset	This is unaffected by a Preset but is set to 0 dB on a "Restore Input/Output Defaults" or "Restore System Defaults->All"
Min	100 dB
Max	-100 dB
Initial S/W Revision	Prior to A.02.00

Restore Input/Output Defaults

This selection causes the group of settings and data associated with the **Input/Output** key to be a reset to their default values. In addition, when a Source is installed, licensed and selected, Restore Input/Output defaults will initiate a Source Preset.

This level of Restore System Defaults does not affect any other system settings or mode settings and does not cause a mode switch. All the features described in this section are reset using this key, including Input Corrections and Data (described in the Corrections section).

Key Path	Input/Output
Example	:SYST:DEF INP presets all the Input/Output variables to their factory default values.
Notes	Refer to the Utility Functions for information about Restore System Defaults and the complete description of the :SYSTem:DEFault INPut: command.
Initial S/W Revision	Prior to A.02.00

Corrections

This key accesses the Amplitude Corrections menu.

Amplitude Corrections arrays can be entered, sent over SCPI, or loaded from a file. They allow you to correct the response of the analyzer for various use cases. The X-series supports four separate Corrections arrays, each of which can contain up to 2000 points. They can be turned on and off individually and any or all can be on at the same time.

Trace data is in absolute units and corrections data is in relative units, but we want to be able to display trace data at the same time as corrections data. Therefore we establish a reference line to be used while building or editing a Corrections table. The reference line is halfway up the display and represents 0 dB of correction. It is labeled "0 dB CORREC". It is drawn in blue.

Corrections data is always in dB. Whatever dB value appears in the correction table represents the correction applied to that trace at that frequency. So if a table entry shows 30 dB that means we ADD 30 dB to each trace to correct it before displaying it.

In zero span, where the frequency is always the center frequency of the analyzer, we apply the (interpolated) correction for the center frequency to all points in the trace. In the event where there are two correction amplitudes at the center frequency, we apply the first one in the table.

Note that the corrections are applied as the data is taken; therefore, a trace in **View** (Update Off) will not be affected by changes made to the corrections table after the trace is put in **View**.

On the RF Input/Output panel, there are two full-duplex RF ports (RFIO1 and RFIO2), RF Input and RF Output. When RF Input is selected, it will correspond to one input port from two half-duplex RF ports (RFIO3 and RFIO4), and when RF Output is selected, it will correspond to one output port from two half-duplex RF ports (RFIO3 and RFIO4). So there are 8 sets of corrections in all that can be applied to the RF ports. Ports cannot share the same set of corrections but a single port can have multiple corrections applied to it. The correction data is applied to incoming signals as well as transmitted signals and is in the form of a list of spot frequencies and amplitude correction levels.

Key Path	Input/Output, Corrections
Mode	SA, I/Q Analyzer, Phase Noise, VXA, RTSA, EMI Receiver, DVB-T/H, DTMB, DVB-T/H, DTMB, W-CDMA, LTE & LTE-Adv FDD, LTE & LTE-Adv TDD, Sequence Analyzer, BTooth, WLAN
Dependencies	This key will only appear if you have the proper option installed in your instrument. Amplitude correction may not be available in all modes; if a mode does not support amplitude correction, the Corrections key should be blanked while in that mode. If an application supports corrections but the current measurement does not, then the key should be grayed out in that measurement
Preset	Corrections arrays are reset (deleted) by Restore Input/Output Defaults. They survive shutdown and restarting of the analyzer application, which means they will survive a power cycle.
Initial S/W Revision	A.02.00
Modified at S/W Revision	x.14.50

Select Correction

Specifies the selected correction. The term "selected correction" is used throughout this document to specify which correction will be affected by the functions.

Key Path	Input/Output, Corrections
Mode	SA, I/Q Analyzer, Phase Noise, VXA, RTSA, EMI Receiver, DVB-T/H, DTMB, DVB-T/H, DTMB, W-CDMA, LTE & LTE-Adv FDD, LTE & LTE-Adv TDD, Sequence Analyzer, BTooth
Notes	The selected correction is remembered even when not in the correction menu.
Preset	Set to Correction 1 by Restore Input/Output Defaults
Readback	Correction 1 Correction 2 Correction 3 Correction 4 Correction 5 Correction 6 Correction 7 Correction 8
Initial S/W Revision	A.02.00
Modified at S/W Revision	x.14.50

Correction On/Off

Turning the Selected Correction from the OFF state to the ON state allows the values in it to be applied to the data. This state transition also automatically turns on "Apply Corrections" (sets it to ON), otherwise the correction would not take effect.

A new sweep is initiated if an amplitude correction is switched on or off. Note that changing, sending or loading corrections data does NOT directly initiate a sweep, however in general these operations will turn corrections on, which DOES initiate a sweep.

Key Path	Input/Output, Corrections
Remote Command	[:SENSe] :CORRection:CSET [1 2 . . . 8 [:STATe] ON OFF 1 0 [:SENSe] :CORRection:CSET [1 2 . . . 8 [:STATe] ?

Example	SENS:CORR:CSET1 ON
Dependencies	<p>Changing this from the OFF state to the ON state automatically turns on "Apply Corrections".</p> <p>Only the first correction array (Correction 1) supports antenna units. When this array is turned on, and it contains an Antenna Unit other than "None", the Y Axis Unit of the analyzer is forced to that Antenna Unit. All other Y Axis Unit choices are grayed out.</p> <p>Note that this means that a correction file with an Antenna Unit can only be loaded into the Corrections 1 register. Consequently only for Correction 1 does the dropdown in the Recall dialog include.ant, and if an attempt is made to load a correction file into any other Correction register which DOES contain an antenna unit, a Mass Storage error is generated.</p> <p>This command will generate an "Option not available" error unless you have the proper option installed in your instrument.</p>
Preset	Not affected by a Preset. Set to OFF by Restore Input/Output Defaults
State Saved	Saved in instrument state.
Backwards Compatibility Notes	Unlike legacy analyzers, Preset does not turn Corrections off (Restore Input/Output Defaults does).
Initial S/W Revision	A.02.00
Modified at S/W Revision	A.14.00

Properties

Accesses a menu that lets you set the properties of the selected correction.

Key Path	Input/Output, Corrections
Initial S/W Revision	A.02.00

Select Correction

Specifies the selected correction. The term "selected correction" is used throughout this document to specify which correction will be affected by the functions.

Key Path	Input/Output, Corrections
Mode	SA, I/Q Analyzer, Phase Noise, VXA, RTSA, EMI Receiver, DVB-T/H, DTMB, DVB-T/H, DTMB, W-CDMA, LTE & LTE-Adv FDD, LTE & LTE-Adv TDD, Sequence Analyzer, BTooth
Notes	The selected correction is remembered even when not in the correction menu.
Preset	Set to Correction 1 by Restore Input/Output Defaults
Readback	Correction 1 Correction 2 Correction 3 Correction 4 Correction 5 Correction 6 Correction 7 Correction 8
Initial S/W Revision	A.02.00
Modified at S/W Revision	x.14.50

Antenna Unit

For devices (like antennas) that make measurements of field strength or flux density, the correction array should contain within its values the appropriate conversion factors such that, when the data on the analyzer is presented in dB μ V, the display is calibrated in the appropriate units. The "Antenna Unit" used for the conversion is contained within the corrections array database. It may be specified or loaded in from an external file or SCPI.

When an array with an Antenna Unit other than "None" is turned on, the Y Axis Unit of the analyzer is forced to that unit. When this array is turned on, and it contains an Antenna Unit other than "None", the Y Axis Unit of the analyzer is forced to that Antenna Unit., and all other Y Axis Unit choices are grayed out.

Antenna Unit does not appear in all Modes that support Corrections. Only the modes listed in the Mode row of the table below support Antenna Units.

Key Path	Input/Output, Corrections, Properties
Mode	SA, I/Q Analyzer, Phase Noise, VXA, RTSA, EMI Receiver, DVB-T/H, DTMB, DVB-T/H, DTMB, W-CDMA, LTE & LTE-Adv FDD, LTE & LTE-Adv TDD, Sequence Analyzer, BTooth
Remote Command	[:SENSE] :CORRection:CSET[1]:ANTenna[:UNIT] GAUSS PTES1a UVM UAM UA NOConversion [:SENSE] :CORRection:CSET[1]:ANTenna[:UNIT] ?
Example	CORR:CSET:ANT GAUS
Dependencies	Only the first correction array (Correction 1) supports antenna units. Note that this means that a correction file with an Antenna Unit can only be loaded into the Corrections 1 register. Consequently only for Correction 1 does the dropdown in the Recall dialog include.ant, and if an attempt is made to load a correction file into any other Correction register which DOES contain an antenna unit, a Mass Storage error is generated.
Preset	Unaffected by Preset. Set to NOC by Restore Input/Output Defaults
State Saved	Saved in instrument state
Initial S/W Revision	A.02.00
Modified at S/W Revision	x.14.50

None

Selects no antenna unit for this Correction set. Thus no Y Axis unit will be forced.

Key Path	Input/Output, Corrections, Properties, Antenna Unit
Example	:CORR:CSET:ANT NOC
Readback	"None"
Initial S/W Revision	A.02.00

dB μ V/m

Sets the antenna unit to dB μ V/m. If this correction is turned on, and Apply Corrections is on, the Y Axis Unit will then be forced to dB μ V/m and all other Y Axis Unit selections will be grayed out.

Key Path	Input/Output, Corrections, Properties, Antenna Unit
Example	:CORR:CSET:ANT UVM
Readback	"dB μ V/m"
Initial S/W Revision	A.02.00

dB μ A/m

Sets the antenna unit to dB μ A/m. If this correction is turned on, and Apply Corrections is on, the Y Axis Unit will then be forced to dB μ A/m and all other Y Axis Unit selections will be grayed out.

Key Path	Input/Output, Corrections, Properties, Antenna Unit
Example	:CORR:CSET:ANT UVA
Readback	" dB μ A/m"
Initial S/W Revision	A.02.00

dBpT

Sets the antenna unit to dBpT. If this correction is turned on, and Apply Corrections is on, the Y Axis Unit will then be forced to dBpT and all other Y Axis Unit selections will be grayed out.

Key Path	Input/Output, Corrections, Properties, Antenna Unit
Example	:CORR:CSET:ANT PTES
Readback	"dBpT"
Initial S/W Revision	A.02.00

dBG

Sets the antenna unit to dBG. If this correction is turned on, and Apply Corrections is on, the Y Axis Unit will then be forced to dBG and all other Y Axis Unit selections will be grayed out.

Key Path	Input/Output, Corrections, Properties, Antenna Unit
Example	:CORR:CSET:ANT GAUS
Readback	" dBG"
Initial S/W Revision	A.02.00

dB μ A

Sets the antenna unit to dB μ A. If this correction is turned on, and Apply Corrections is on, the Y Axis Unit will then be forced to dB μ A and all other Y Axis Unit selections will be grayed out.

Key Path	Input/Output, Corrections, Properties, Antenna Unit
Example	:CORR:CSET:ANT UA
Readback	" dBμA"
Initial S/W Revision	A.11.00

Frequency Interpolation

This setting controls how the correction values per-bucket are calculated. We interpolate between frequencies in either the logarithmic or linear scale.

This setting is handled and stored individually per correction set.

See ["Interpolation" on page 116](#)

Key Path	Input/Output, Corrections, Properties
Remote Command	[:SENSe] :CORRection:CSET[1] 2 ... 8 :X:SPACing LINear LOGarithmic [:SENSe] :CORRection:CSET[1] 2 ... 8 :X:SPACing?
Example	CORR:CSET:X:SPAC LIN
Preset	Unaffected by a Preset. Set to Linear by Restore Input/Output Defaults.
State Saved	Saved in instrument state.
Initial S/W Revision	A.02.00
Modified at S/W Revision	A.14.00

Interpolation

For each bucket processed by the application, all of the correction factors at the frequency of interest (center frequency of each bucket) are summed and added to the amplitude. All trace operations and post processing treat this post-summation value as the true signal to use.

To effect this correction, the goal, for any particular start and stop frequency, is to build a correction trace, whose number of points matches the current Sweep Points setting of the instrument, which will be used to apply corrections on a bucket by bucket basis to the data traces.

For amplitudes that lie between two user specified frequency points, we interpolate to determine the amplitude value. You may select either linear or logarithmic interpolation between the frequencies.

If we interpolate on a log scale, we assume that the line between the two points is a straight line on the log scale. For example, let's say the two points are (2,4) and (20,1). A straight line between them on a log scale looks like:

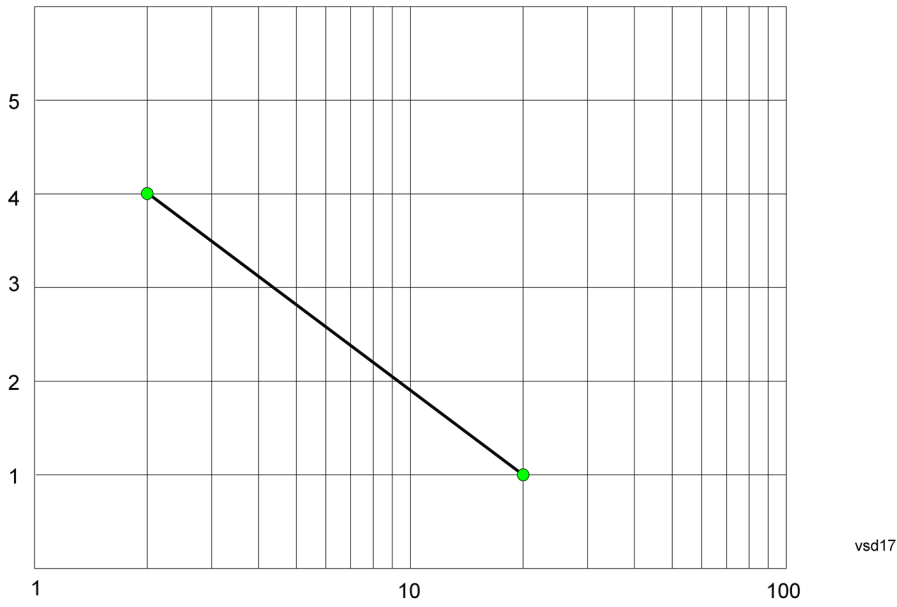

On a linear scale (like that of the spectrum analyzer), this translates to:

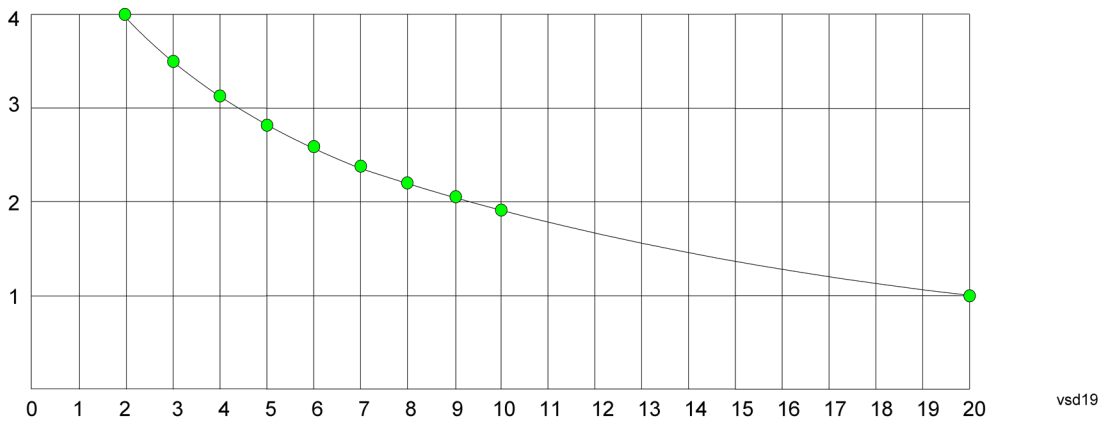

If we interpolate on a linear scale, we assume that the two points are connected by a straight line on the linear scale, as below:

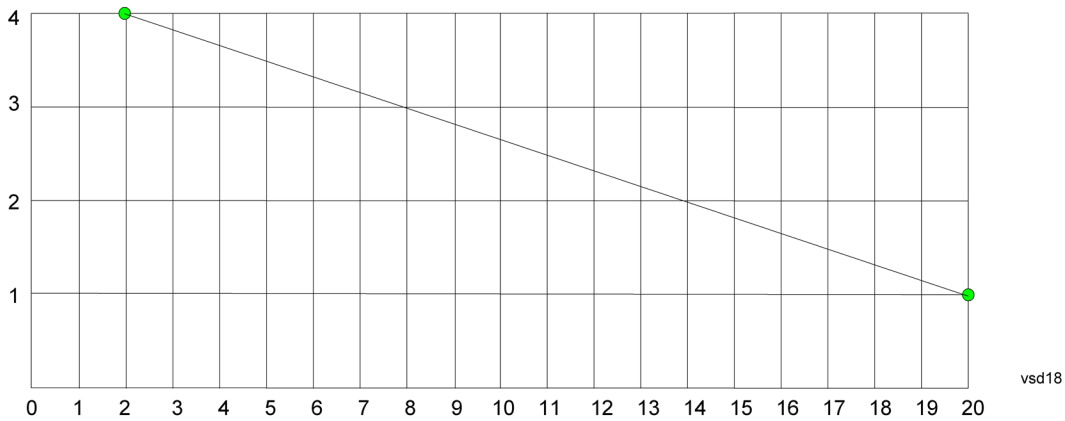

The correction to be used for each bucket is taken from the interpolated correction curve at the center of the bucket.

Description

Sets an ASCII description field which will be stored in an exported file. Can be displayed in the active function area by selecting as the active function, if desired to appear in a screen capture.

Key Path	Input/Output, Corrections, Properties
Remote Command	<code>[[:SENSe]:CORRection:CSET[1] 2 ... 8:DESCRiption "text"</code> <code>[[:SENSe]:CORRection:CSET[1] 2 ... 8:DESCRiption?</code>
Example	<code>:CORR:CSET1:DESC "11941A Antenna correction"</code>
Notes	45 chars max; may not fit on display if max chars used
Preset	Unaffected by a Preset. Set to empty by Restore Input/Output Defaults
State Saved	Saved in instrument state.
Initial S/W Revision	A.02.00
Modified at S/W Revision	A.14.00

Comment

Sets an ASCII comment field which will be stored in an exported file. Can be displayed in the active function area by selecting as the active function, if desired to appear in a screen capture.

Key Path	Input/Output, Corrections, Properties
Remote Command	<code>[[:SENSe]:CORRection:CSET[1] 2 ... 8:COMMent "text"</code> <code>[[:SENSe]:CORRection:CSET[1] 2 ... 8:COMMent?</code>
Example	<code>:CORR:CSET1:COMM "this is a comment"</code>
Notes	60 chars max; may not fit on display if max chars used
Preset	Unaffected by Preset. Set to empty by Restore Input/Output Defaults
State Saved	Saved in instrument state
Initial S/W Revision	A.02.00
Modified at S/W Revision	A.14.00

RF Port

Maps one of the sets of corrections to one of the IO ports.

Key Path	Input/Output, Corrections, Properties
Mode	SEQAN
Remote Command	<code>[[:SENSe]:CORRection:CSET[1] 2 ... 8:RF:PORT RFIN RFIO1 RFIO2 </code> <code>RFOut GPSout GNSSout RFIO3 RFIO4</code> <code>[[:SENSe]:CORRection:CSET[1] 2 ... 8:RF:PORT?</code>

Example	:CORR:CSET:RF:PORT RFIN
Remote Command Notes	
Dependencies	RFIO1 and RFIO2 are not available in E6607C and E6630A GPSout (GNSSout) are only available in E6607C and E6630A
Couplings	
Preset	Unaffected by Preset. Set to RF by Restore Input/Output Defaults
State Saved	Saved in State
Initial S/W Revision	A.05.01
Modified at S/W Revision	A.14.00

RF Input

The port that the current corrections will be applied to.

Key Path	Input/Output, Corrections, Properties, RF Port
Example	:CORR:CSET:RF:PORT RFIN
Dependencies	Not available in E6607C
ReadBack	RF IN
Initial S/W Revision	A.05.01
Modified at S/W Revision	A.14.00

RFOut

The port that the current corrections will be applied to.

Key Path	Input/Output, Corrections, Properties, RF Port
Example	:CORR:CSET:RF:PORT RFO
Dependencies	Not available in E6607C
ReadBack	RFOut
Initial S/W Revision	A.05.01
Modified at S/W Revision	A.14.00

RFIO1

The port that the current corrections will be applied to. Pressing this key again allows the user access to the menu for specifying which internal device the corrections for RFIO 1 will be applied to.

Key Path	Input/Output, Corrections, Properties, RF Port
Remote Command	[:SENSe] :CORRection:CSET [1] 2 ... 8 :RF:PORT:RFIO1 SOURce ANALyzer BOTH [:SENSe] :CORRection:CSET [1] 2 ... 8 :RF:PORT:RFIO1 ?
Example	:CORR:CSET:RF:PORT:RFIO1 BOTH
Preset	Both
State Saved	Saved in State

Correct Source

Sets the corrections for the RFIO1 port to be applied to the source.

Key Path	Input/Output, Corrections, Properties, RF Port
Example	:CORR:CSET:RF:PORT:RFIO1 SOUR
Readback	"Correct Source"

Correct Analyzer

Sets the corrections for the RFIO1 port to be applied to the analyzer.

Key Path	Input/Output, Corrections, Properties, RF Port
Example	:CORR:CSET:RF:PORT:RFIO1 ANAL
Readback	"Correct Analyzer"

Correct Source and Analyzer

Sets the corrections for the RFIO1 port to be applied to both the source and the analyzer.

Key Path	Input/Output, Corrections, Properties, RF Port
Example	:CORR:CSET:RF:PORT:RFIO1 BOTH
Readback	"Correct Source and Analyzer"

RFIO2

The port that the current corrections will be applied to. Pressing this key again allows the user access to the menu for specifying which internal device the corrections for RFIO 2 will be applied to.

Key Path	Input/Output, Corrections, Properties, RF Port
Remote Command	[:SENSe] :CORRection:CSET [1] 2 ... 8 :RF:PORT:RFIO2 SOURce ANALyzer BOTH [:SENSe] :CORRection:CSET [1] 2 ... 8 :RF:PORT:RFIO2 ?

Example	:CORR:CSET:RF:PORT:RFIO2 BOTH
Preset	Both
State Saved	Saved in State

Correct Source

Sets the corrections for the RFIO2 port to be applied to the source.

Key Path	Input/Output, Corrections, Properties, RF Port
Example	:CORR:CSET:RF:PORT:RFIO2 SOUR
Readback	"Correct Source"

Correct Analyzer

Sets the corrections for the RFIO2 port to be applied to the analyzer.

Key Path	Input/Output, Corrections, Properties, RF Port
Example	:CORR:CSET:RF:PORT:RFIO2 ANAL
Readback	"Correct Analyzer"

Correct Source and Analyzer

Sets the corrections for the RFIO2 port to be applied to both the source and the analyzer.

Key Path	Input/Output, Corrections, Properties, RF Port
Example	:CORR:CSET:RF:PORT:RFIO2 BOTH
Readback	"Correct Source and Analyzer"

Edit

Invokes the integrated editing facility for this correction set.

When entering the menu, the editor window turns on, the selected correction is turned **On**, **Apply Corrections** is set to **On**, the amplitude scale is set to **Log**, and the Amplitude Correction ("Ampcor") trace is displayed. The actual, interpolated correction trace is shown in green for the selected correction. Note that since the actual interpolated correction is shown, the correction trace may have some curvature to it. This trace represents only the correction currently being edited, rather than the total, accumulated amplitude correction for all amplitude corrections which are currently on, although the total, accumulated correction for all corrections which are turned on is still applied to the data traces.

Because corrections data is always in dB, but the Y-axis of the analyzer is in absolute units, it is necessary to establish a reference line for display of the Corrections data. The reference line is halfway up the display and represents 0 dB of correction. It is labeled "0 dB CORREC". It is drawn in blue.

Corrections data is always in dB. Whatever dB value appears in the correction table represents the correction to be applied to that trace at that frequency. So if a table entry shows 30 dB that means we ADD 30 dB to each trace to correct it before displaying it. By definition all points are connected. If a gap is desired for corrections data, enter 0 dB.

Note that a well-designed Corrections array should start at 0 dB and end at 0 dB. This is because whatever the high end point is will be extended to the top frequency of the instrument, and whatever the low end point is will be extended down to 0 Hz. So for a Corrections array to have no effect outside its range, you should start and end the array at 0 dB.

NOTE The table editor will only operate properly if the analyzer is sweeping, because its updates are tied to the sweep system. Thus, you should not try to use the editor in single sweep, and it will be sluggish during compute-intensive operations like narrow-span FFT sweeps.

When exiting the edit menu (by using the **Return** key or by pressing an instrument front-panel key), the editor window turns off and the Ampcor trace is no longer displayed; however, **Apply Corrections** remains **On**, any correction that was on while in the editor remains on, and the amplitude scale returns to its previous setting.

Corrections arrays are not affected by a Preset, because they are in the Input/Output system. They also survive shutdown and restarting of the analyzer application, which means they will survive a power cycle.

When editing a correction, the editor remembers which correction and which element in the correction array you were editing, and returns you to that correction and that element when you return to the editor after leaving it.

Key Path	Input/Output, Corrections
Initial S/W Revision	A.02.00

Navigate

Lets you move through the table to edit the desired point.

Key Path	Input/Output, Corrections, Edit
Notes	There is no value readback on the key
Min	1
Max	2000
Initial S/W Revision	A.02.00

Frequency

Lets you edit the frequency of the current row.

Key Path	Input/Output, Corrections, Edit
Notes	There is no value readback on the key.
Min	0
Max	1 THz
Initial S/W Revision	A.02.00

Amplitude

Lets you edit the Amplitude of the current row.

Key Path	Input/Output, Corrections, Edit
Notes	There is no value readback on the key.
Min	-1000 dB
Max	1000 dB
Initial S/W Revision	A.02.00

Insert Point Below

Inserts a point below the current point. The new point is a copy of the current point and becomes the current point. The new point is not yet entered into the underlying table, and the data in the row is displayed in light gray.

Key Path	Input/Output, Corrections, Edit
Initial S/W Revision	A.02.00

Delete Point

Deletes the currently-selected point, whether or not that point is being edited, and selects the Navigate functionality. The point following the currently-selected point (or the point preceding if there is none) will be selected.

Key Path	Input/Output, Corrections, Edit
Initial S/W Revision	A.02.00

Delete Correction

Deletes the correction values for this set. When this key is pressed a prompt is placed on the screen that says "Please press Enter or OK key to delete correction. Press ESC or Cancel to close this dialog." The deletion is only performed if you press OK or Enter.

Key Path	Input/Output, Corrections
Remote Command	[:SENSe] :CORRection:CSET[1] 2 ... 6 :DELete
Example	CORR:CSET:DEL CORR:CSET1:DEL CORR:CSET4:DEL
Notes	Pressing this key when no corrections are present is accepted without error.
Initial S/W Revision	A.02.00

Apply Corrections

Applies amplitude corrections, which are marked as ON to the measured data. If this is set to OFF, then no amplitude correction sets will be used, regardless of their individual on/off settings. If set to ON, the corrections that are marked as ON (see "[Correction On/Off](#)" on page 112) are used.

Key Path	Input/Output, Corrections
Remote Command	[:SENSe] :CORRection:CSET:ALL [:STATe] ON OFF 1 0 [:SENSe] :CORRection:CSET:ALL [:STATe] ?
Example	SENS:CORR:CSET:ALL OFF This command makes sure that no amplitude corrections are applied, regardless of their individual on/off settings.
Preset	Not affected by Preset. Set to OFF by Restore Input/Output Defaults
State Saved	Saved in instrument state.
Initial S/W Revision	A.02.00

Delete All Corrections

Erases all correction values for all 4 Amplitude Correction sets.

When this key is pressed a prompt is placed on the screen that says "Please press Enter or OK key to delete all corrections. Press ESC or Cancel to close this dialog." The deletion is only performed if you press OK or Enter.

Key Path	Input/Output, Corrections
Remote Command	[:SENSe] :CORRection:CSET:ALL:DELete
Example	CORR:CSET:ALL:DEL
Initial S/W Revision	A.02.00

Set (Replace) Data (Remote Command Only)

The command takes an ASCII series of alternating frequency and amplitude points, each value separated by commas.

The values sent in the command will totally replace all existing correction points in the specified set.

An Ampcor array can contain 2000 points maximum.

Remote Command	<code>[[:SENSE]:CORRection:CSET[1] 2 ... 8:DATA <freq>, <ampl>, . . .</code> <code>[[:SENSE]:CORRection:CSET[1] 2 ... 8:DATA?</code>
Example	<code>CORR:CSET1:DATA 10000000, -1.0, 20000000, 1.0</code> This defines two correction points at (10 MHz, -1.0 dB) and (20 MHz, 1.0 dB) for correction set 1.
Preset	Empty after Restore Input/Output Defaults. Survives a shutdown or restart of analyzer application (including a power cycle).
State Saved	Saved in instrument state.
Min	Freq: 0 Hz Amptd: -1000 dBm
Max	Freq: 1 THz Amptd: +1000 dBm
Initial S/W Revision	A.02.00
Modified at S/W Revision	A.14.00

Merge Correction Data (Remote Command Only)

The command takes an ASCII series of alternating frequency and amplitude points, each value separated by commas. The difference between this command and Set Data is that this merges new correction points into an existing set.

Any new point with the same frequency as an existing correction point will replace the existing point's amplitude with that of the new point.

An Ampcor array can contain 2000 total points, maximum.

Remote Command	<code>[[:SENSE]:CORRection:CSET[1] 2 ... 8:DATA:MERGe <freq>, <ampl>, ...</code>
Example	<code>CORR:CSET1:DATA:MERGE 15000000, -5.0, 25000000, 5.0</code> This adds two correction points at (15 MHz, -5.0 dB) and (25 MHz, 5.0 dB) to whatever values already exist in correction set 1.
Preset	Empty after Restore Input/Output Defaults. Survives shutdown/restart of analyzer application (including power cycle)
Min	Freq: 0 Hz Amptd: -1000 dBm
Max	Freq: 1 THz Amptd: +1000 dBm
Initial S/W Revision	A.02.00
Modified at S/W Revision	A.14.00

Remote Correction Data Set Commands

This section describes the remote (SCPI) commands used to put values into correction sets. See the correction / table editor section of the Input/Output section for the information on front panel entry of correction data.

"Set (Replace) Data (Remote Command Only)" on page 126

"Merge Correction Data (Remote Command Only)" on page 126

Set (Replace) Data (Remote Command Only)

The command takes an ASCII series of alternating frequency and amplitude points, each value separated by commas.

The values sent in the command will totally replace all existing correction points in the specified set.

An Ampcor array can contain 2000 points maximum.

Remote Command	<code>[[:SENSe]:CORRection:CSET[1] 2 ... 8:DATA <freq>, <ampl>, . . .</code> <code>[[:SENSe]:CORRection:CSET[1] 2 ... 8:DATA?</code>
Example	<code>CORR:CSET1:DATA 10000000, -1.0, 20000000, 1.0</code> This defines two correction points at (10 MHz, -1.0 dB) and (20 MHz, 1.0 dB) for correction set 1.
Preset	Empty after Restore Input/Output Defaults. Survives a shutdown or restart of analyzer application (including a power cycle).
State Saved	Saved in instrument state.
Min	Freq: 0 Hz Amptd: -1000 dBm
Max	Freq: 1 THz Amptd: +1000 dBm
Initial S/W Revision	A.02.00
Modified at S/W Revision	A.14.00

Merge Correction Data (Remote Command Only)

The command takes an ASCII series of alternating frequency and amplitude points, each value separated by commas. The difference between this command and Set Data is that this merges new correction points into an existing set.

Any new point with the same frequency as an existing correction point will replace the existing point's amplitude with that of the new point.

An Ampcor array can contain 2000 total points, maximum.

Remote Command	<code>[[:SENSe]:CORRection:CSET[1] 2 ... 8:DATA:MERGE <freq>, <ampl>, ...</code>
Example	<code>CORR:CSET1:DATA:MERGE 15000000, -5.0, 25000000, 5.0</code> This adds two correction points at (15 MHz, -5.0 dB) and (25 MHz, 5.0 dB) to whatever values already exist in correction set 1.

Preset	Empty after Restore Input/Output Defaults. Survives shutdown/restart of analyzer application (including power cycle)
Min	Freq: 0 Hz Amptd: -1000 dBm
Max	Freq: 1 THz Amptd: +1000 dBm
Initial S/W Revision	A.02.00
Modified at S/W Revision	A.14.00

Freq Ref In

Specifies the frequency reference as being the internal reference at the rear panel input labeled EXT REF IN, a 1 pulse per second signal at the EXT REF IN input,, external reference or sensing the presence of a signal at the EXT REF IN input.

When the frequency reference is set to internal, the internal 10 MHz reference is used even if an external reference is connected.

When the frequency reference is set to external, the instrument will use the external reference. However, if there is no external signal present, or it is not within the proper amplitude range, a condition error message is generated. When the external signal becomes valid, the error is cleared.

When the frequency reference is set to Pulse, the instrument expects a 1 pulse per second signal at the EXT REF IN input. The instrument uses this signal to adjust the frequency of the internal reference.

If Sense is selected, the instrument checks whether a signal is present at the external reference connector. If it senses a signal within 5 ppm of the External Ref Freq (as set on the **External Ref Freq** softkey), it will automatically switch to the external reference. If it senses a 1 pulse per second signal, it enters Pulse mode, wherein the signal is used to adjust the internal reference. When no signal is present, it automatically switches to the internal reference. No message is generated as the reference switches between pulse, external and internal. The monitoring of the external reference occurs approximately on 1 millisecond intervals, and never occurs in the middle of a measurement acquisition, only at the end of the measurement (end of the request).

If for any reason the instrument's frequency reference is not able to obtain lock, Status bit 1 in the Questionable Frequency register will be true and a condition error message is generated. When lock is regained, Status bit 1 in the Questionable Frequency register will be cleared and the condition error will be cleared.

If an external frequency reference is being used, you must enter the frequency of the external reference if it is not exactly 10 MHz. The External Ref Freq key is provided for this purpose.

Key Path	Input/Output
Remote Command	[:SENSe] :ROSCillator :SOURCE :TYPE INTernal EXTernal SENSE PULSE [:SENSe] :ROSCillator :SOURCE :TYPE?
Dependencies	The PULSE parameter, and support of the 1 pps signal at the EXT REF IN input, are not available in firmware prior to A.13.00. They are also not available in some model numbers. If not available, the

	Pulse key will be blank, and sending the PULSe parameter via SCPI will generate an error:
Preset	This is unaffected by a Preset but is set to SENSE on a "Restore Input/Output Defaults" or "Restore System Defaults->All".
State Saved	Saved in instrument state.
Status Bits/OPC dependencies	STATus:QUESTIONable:FREQuency bit 1 set if unlocked.
Backwards Compatibility Notes	Freq Ref In was not saved in state in the legacy instruments. It is a part of state in the X-Series.
Initial S/W Revision	Prior to A.02.00
Modified at S/W Revision	A.14.00

Remote Command	<code>[[:SENSe]:ROSCillator:SOURce?</code>
Notes	<p>The query <code>[SENSe]:ROSCillator:SOURce?</code> returns the current switch setting. This means:</p> <ol style="list-style-type: none"> 1. If it was set to SENSE but there is no external reference nor 1 pps signal so the instrument is actually using the internal reference, then this query returns INTernal and not SENSE. 2. If it was set to SENSE and there is an external reference present, the query returns EXTernal and not SENSE. 3. If it was set to SENSE and there is a 1 pps signal present, the query returns PULSe and not SENSE. 4. If it was set to EXTernal, then the query returns "EXTernal" 5. If it was set to INTernal, then the query returns "INTernal". 6. If it was set to PULSe, then the query returns "PULSe"
Preset	SENSe
Backwards Compatibility Notes	<p>The query <code>[[:SENSe]:ROSCillator:SOURce?</code> was a query-only command in ESA which always returned whichever reference the instrument was using. The instrument automatically switched to the ext ref if it was present.</p> <p>In PSA (which had no sensing) the command <code>[[:SENSe]:ROSCillator:SOURce</code> set the reference (INT or EXT), so again its query returned the actual routing.</p> <p>Thus the query form of this command is 100% backwards compatible with both instruments.</p>
Initial S/W Revision	Prior to A.02.00

Remote Command	<code>[[:SENSe]:ROSCillator:SOURce INTernal EXTernal</code>
Notes	For PSA compatibility the command form is provided and is directly mapped to <code>[[:SENSe]:ROSCillator:SOURce:TYPE</code>
Initial S/W Revision	Prior to A.02.00

Sense

If Sense is selected, the instrument checks whether a signal is present at the external reference connector. If it senses a signal within 5 ppm of the External Ref Freq (as set on the **External Ref Freq** softkey), it will use this signal as an External Reference. If it senses a 1 pulse per second signal, it will use this signal to adjust the internal reference by adjusting the User setting of the Timebase DAC. When no signal is present, it automatically switches to the internal reference.

Key Path	Input/Output, Freq Ref In
Example	:ROSC:SOUR:TYPE SENS
Couplings	If set to SENSE and the analyzer senses a 1 pulse per second signal, it sets the System, Alignments, Timebase DAC setting to "User". This setting survives Preset and Power Cycle but is set to "Calibrated" on a System, Restore Defaults, Align or a System, Restore Defaults, All
Readback	Sense
Initial S/W Revision	Prior to A.02.00
Modified at S/W Revision	A.14.00

Internal

The internal reference is used. A 1 pps signal at the EXT REF IN port, or a signal there between 1 and 50 MHz, will cause a warning triangle to appear in the settings panel next to the word "INTERNAL", but will otherwise be ignored.

Key Path	Input/Output, Freq Ref In
Example	:ROSC:SOUR:TYPE INT
Readback	Internal
Initial S/W Revision	Prior to A.02.00
Modified at S/W Revision	A.14.00

External

The external reference is used.

Key Path	Input/Output, Freq Ref In
Example	:ROSC:SOUR:TYPE EXT
Readback	External
Initial S/W Revision	Prior to A.02.00

Ext Ref Freq

This key tells the analyzer the frequency of the external reference. When the external reference is in use (either because the reference has been switched to External or because the Reference has been switched

to Sense and there is a valid external reference present) this information is used by the analyzer to determine the internal settings needed to lock to that particular external reference signal.

For the instrument to stay locked, the value entered must be within 5 ppm of the actual external reference frequency. So it is important to get it close, or you risk an unlock condition.

Note that this value only affects the instrument's ability to lock. It does not affect any calculations or measurement results. See "Freq Offset" in the Frequency section for information on how to offset frequency values.

Key Path	Input/Output, Freq Ref In
Remote Command	[:SENSe] :ROSCillator:EXTernal:FREQuency <freq> [:SENSe] :ROSCillator:EXTernal:FREQuency?
Example	ROSC:EXT:FREQ 20 MHz sets the external reference frequency to 20 MHz, but does not select the external reference. ROSC:SOUR:TYPE EXT selects the external reference.
Dependencies	Still available with Internal or Pulse selected, to allow setup for when External is in use. However, the setting has no effect if the Internal Reference is in use (Freq Ref In set to Internal, Pulse, or SENSE:INT or SENSE:PULSE).
Preset	This is unaffected by a Preset but is set to 10 MHz on a "Restore Input/Output Defaults" or "Restore System Defaults->All"
Default Unit	Hz
Initial S/W Revision	Prior to A.02.00
Modified at S/W Revision	A.14.00

RF Output & Test Set Config

The RF Output & Test Set Config key allows you to set the RF Output Port and multiport adapter unit which is connected to the instrument by USB for download of calibration data and additional control.

This menu also allows you to set Trigger Config which is used to set the input/output type of the 4 Bi-directional Trigger ports.

Key Path	Input/Output
Preset	All settings under this key are returned to their default state when Restore Input/Output Defaults is pressed.
State Saved	Saved in State
Initial S/W Revision	A.09.49

RF Output

Specifies the RF Output Port used.

Switching from the RF Output port to one of the RFIO ports changes the transmitter performance of the instrument.

Key Path	Input/Output, RF Output & Test Set Config
Remote Command	[:SENSe] :FEED:RF:PORT:OUTPut RFOut RFIO1 RFIO2 GPSout GNSSout RFIO3 RFIO4 [:SENSe] :FEED:RF:PORT:OUTPut?
Example	:FEED:RF:PORT:OUTP RFIO1
Preset	This is unaffected by Mode Preset but is set to RFOut on a "Restore Input/Output Defaults" or "Restore System Defaults -> All"
State Saved	Saved in State
Readback	The current RF Output Port selected is read back to this key
Initial S/W Revision	A.05.01
Modified at S/W Revision	A.14.00

RF Output

The RF port that will be used for the current output.

Key Path	Input/Output, RF Output & Test Set Config, RF Output
Example	:FEED:RF:PORT:OUTP RFO
Notes	If RF Output is selected as RF Output Port, you need to choose the settings in the Half Duplex Config menu to determine which port (RFIO3 or RFIO4) will be used.
ReadBack	RF Output
Initial S/W Revision	A.05.01
Modified at S/W Revision	A.14.00

RFIO1

The RF port that will be used for the current output

Key Path	Input/Output, RF Output & Test Set Config, RF Output
Example	:FEED:RF:PORT:OUTP RFIO1
Dependencies	Not available in E6607C.
ReadBack	RFIO1
Initial S/W Revision	A.05.01

RFIO2

The RF port that will be used for the current output

Key Path	Input/Output, RF Output & Test Set Config, RF Output
----------	---

Example	:FEED:RF:PORT:OUTP RFIO2
Dependencies	Not available in E6607C.
ReadBack	RFIO2
Initial S/W Revision	A.05.01

HalfDuplex Config

The HalfDuplex Config key allows you to set “RF Input” of RF Input Port menu and ”RF Output” of RF Output Port menu, which will correspond to RFIO3 and RFIO4.

Key Path	Input/Output, RF Output & Test Set Config
State Saved	Saved in State
Initial S/W Revision	A.14.00

RF Input

Specify the RF Input port from RFIO3 and RFIO4.

Key Path	Input/Output, RF Output & Test Set Config, HalfDuplex Config
Remote Command	[:SENSe] :HDUPlex:PORT:INPut RFIO3 RFIO4
Example	:HDUPlex:PORT:INPut RFIO3 :HDUPlex:PORT:INPut?
Dependencies	If RFIO3 is selected as “RF Output”, then “RF Input” will be set to RFIO4 automatically. And if RFIO4 is selected as “RF Output”, “RF Input” will be set to RFIO3 automatically.
Preset	RFIO3
State Saved	Saved in State
Initial S/W Revision	A.14.00

RF Output

Specify the RF Output port from RFIO3 and RFIO4.

Key Path	Input/Output, RF Output & Test Set Config, HalfDuplex Config
Remote Command	[:SENSe] :HDUPlex:PORT:OUTPut RFIO3 RFIO4
Example	:HDUPlex:PORT:OUTPut RFIO3 :HDUPlex:PORT:OUTPut?
Dependencies	If RFIO3 is selected as “RF Input”, then “RF Output” will be set to RFIO4 automatically. And if RFIO4 is selected as “RF Input”, “RF Output” will be set to RFIO3 automatically.

Preset	RFIO4
State Saved	Saved in State
Initial S/W Revision	A.14.00

Output Config

Accesses keys that configure various output settings, like the frequency reference output, trigger output and analog output.

Key Path	Input/Output
Backwards Compatibility Notes	In ESA there was not a user interface to enable the Video Output (Analog Output), Trigger Output, or Gate Output. In the X-Series each of these physical connectors requires configuration, thus the user interface has been added for X-Series, along with the potential for an output you think is always on to be switched off.
Initial S/W Revision	Prior to A.02.00

Trig Out

Select the type of output signal that will be output from the Trig 1 Out, or Trig 2 Out connectors.

Key Path	Input/Output, Output Config
Remote Command	:TRIGger TRIGger1 TRIGger2[:SEquence]:OUTPut HSWP MEASuring MAIN GATE GTRigger OEVEN SPOint SSWeep SSEtTled S1Marker S2Marker S3Marker S4Marker OFF :TRIGger TRIGger1 TRIGger2[:SEquence]:OUTPut?
Example	TRIG:OUTP HSWP TRIG2:OUTP GATE
Dependencies	The second Trigger output (Trig 2 Out) does not appear in all models; in models that do not support it, the Trig 2 Out key is blanked, and sending the SCPI command for this output generates an error, "Hardware missing; Not available for this model number" In models that do not support the Trigger 2 output, this error is returned if trying to set Trig 2 Out and a query of Trig 2 Out returns OFF.
Preset	Trigger 1: Sweeping (HSWP) Trigger 2: Gate This is unaffected by a Preset but is preset to the above values on a "Restore Input/Output Defaults" or "Restore System Defaults->All"
State Saved	Saved in instrument state
Initial S/W Revision	Prior to A.02.00

Polarity

Sets the output to the Trig 1 Out, or Trig 2 Out, connector to trigger on either the positive or negative polarity.

Key Path	Input/Output, Output Config, Trig 1/2 Output
Remote Command	:TRIGger TRIGger1 TRIGger2[:SEQuence]:OUTPut:POLarity POSitive NEGative :TRIGger TRIGger1 TRIGger2[:SEQuence]:OUTPut:POLarity?
Example	TRIG1:OUTP:POL POS
Preset	This is unaffected by a Preset but is set to POSitive on a "Restore Input/Output Defaults" or "Restore System Defaults->All"
State Saved	Saved in instrument state
Initial S/W Revision	Prior to A.02.00

Off

Selects no signal to be output to the Trig 1 Out, or Trig 2 Out, connector.

Key Path	Input/Output, Output Config, Trig 1/2 Output
Example	TRIG1:OUTP OFF
Readback	Off
Initial S/W Revision	Prior to A.02.00

Sweeping (HSWP)

Selects the Sweeping Trigger signal to be output to the Trig 1 Out, or Trig 2 Out, connector when a measurement is made. This signal has historically been known as "HSWP" (High = Sweeping), and is 5 V TTL level with 50 ohm output impedence.

Key Path	Input/Output, Output Config, Trig 1/2 Output
Example	TRIG1:OUTP HSWP
Readback	Sweeping
Initial S/W Revision	Prior to A.02.00

Measuring

Selects the Measuring trigger signal to be output to the Trig 1 Out, or Trig 2 Out, connector. This signal is true while the Measuring status bit is true.

Key Path	Input/Output, Output Config, Trig 1/2 Output
-----------------	---

Example	TRIG1:OUTP MEAS
Readback	Measuring
Initial S/W Revision	Prior to A.02.00

Main Trigger

Selects the current instrument trigger signal to be output to the Trig 1 Out, or Trig 2 Out, connector.

Key Path	Input/Output, Output Config, Trig 1/2 Output
Example	TRIG1:OUTP MAIN
Readback	Main Trigger
Initial S/W Revision	Prior to A.02.00

Gate Trigger

Selects the gate trigger signal to be output to the Trig 1 Out, or Trig 2 Out, connector. This is the source of the gate timing, not the actual gate signal.

Key Path	Input/Output, Output Config, Trig 1/2 Output
Example	TRIG1:OUTP GTR
Readback	Gate Trigger
Initial S/W Revision	Prior to A.02.00

Gate

Selects the gate signal to be output to the Trig 1 Out, or Trig 2 Out, connector. The gate signal has been delayed and its length determined by delay and length settings. When the polarity is positive, a high on the Trig 1 Out, or Trig 2 Out, represents the time the gate is configured to pass the signal.

Key Path	Input/Output, Output Config, Trig 1/2 Output
Example	TRIG1:OUTP GATE
Readback	Gate
Initial S/W Revision	Prior to A.02.00

Odd/Even Trace Point

Selects either the odd or even trace points as the signal to be output to the Trig 1 Out, or Trig 2 Out, connector when performing swept spectrum analysis. When the polarity is positive, this output goes high during the time the analyzer is sweeping past the first point (Point 0) and every other following trace point. The opposite is true if the polarity is negative.

Key Path	Input/Output, Output Config, Trig 1/2 Output
Example	TRIG1:OUTP OEV
Readback	Odd/Even
Initial S/W Revision	Prior to A.02.00

Trig Out

Select the type of output signal that will be output from the Trig 1 Out, or Trig 2 Out connectors.

Key Path	Input/Output, Output Config
Remote Command	:TRIGger TRIGger1 TRIGger2[:SEquence]:OUTPut HSWP MEASuring MAIN GATE GTRigger OEVen SPOint SSweep SSETtled S1Marker S2Marker S3Marker S4Marker OFF :TRIGger TRIGger1 TRIGger2[:SEquence]:OUTPut?
Example	TRIG:OUTP HSWP TRIG2:OUTP GATE
Dependencies	The second Trigger output (Trig 2 Out) does not appear in all models; in models that do not support it, the Trig 2 Out key is blanked, and sending the SCPI command for this output generates an error, "Hardware missing; Not available for this model number" In models that do not support the Trigger 2 output, this error is returned if trying to set Trig 2 Out and a query of Trig 2 Out returns OFF.
Preset	Trigger 1: Sweeping (HSWP) Trigger 2: Gate This is unaffected by a Preset but is preset to the above values on a "Restore Input/Output Defaults" or "Restore System Defaults->All"
State Saved	Saved in instrument state
Initial S/W Revision	Prior to A.02.00

Off

Selects no signal to be output to the Trig 1 Out, or Trig 2 Out, connector.

Key Path	Input/Output, Output Config, Trig 1/2 Output
Example	TRIG1:OUTP OFF
Readback	Off
Initial S/W Revision	Prior to A.02.00

Source Marker 1

Trigger output at marker 1 in current playing Waveform file.

Key Path	Input/Output, Output Config, Trig 1/2 Output
Example	:TRIG1:OUTP S1M
ReadBack	Marker 1
Initial S/W Revision	A.05.01

Source Marker 2

Trigger output at marker 2 in current playing Waveform file.

Key Path	Input/Output, Output Config, Trig 1/2 Output
Example	:TRIG1:OUTP S2M
ReadBack	Marker 2
Initial S/W Revision	A.05.01

Source Marker 3

Trigger output at marker 3 in current playing Waveform file.

Key Path	Input/Output, Output Config, Trig 1/2 Output
Example	:TRIG1:OUTP S3M
ReadBack	Marker 3
Initial S/W Revision	A.05.01

Source Marker 4

Trigger output at marker 4 in current playing Waveform file.

Key Path	Input/Output, Output Config, Trig 1/2 Output
Example	:TRIG1:OUTP S4M
ReadBack	Marker 4
Initial S/W Revision	A.05.01

Analog Out

This menu lets you control which signal is fed to the “Analog Out” connector on the analyzer rear panel.

See ["More Information" on page 138](#)

Key Path	Input/Output, Output Config
Remote Command	:OUTPut:ANALog OFF SVIDeo LOGVIdeo LINVIdeo DAUDio

	:OUTPut:ANALog?
Example	OUTP:ANAL SVIDeo ! causes the analog output type to be Screen Video
Preset	This is unaffected by Preset but is set to DAUDio on a "Restore Input/Output Defaults" or "Restore System Defaults->All
Preset	OFF
State Saved	Saved in Input/Output State
Readback line	1-of-N selection [variable]
Backwards Compatibility Notes	Prior to A.04.00, OFF was the default functionality except when in the Analog Demod application or with Tune and Listen, in which case it was DAUDio, and there was no selection menu. So for backwards compatibility with earlier X-Series firmware versions, Auto (:OUTP:ANAL:AUTO ON) will duplicate the prior behavior. The DNWB and SANalyzer parameters, which were legal in PSA but perform no function in the X-Series, are accepted without error.
Initial S/W Revision	A.04.00

More Information

The table below gives the range for each output.

Analog Out	Nominal Range exc. (10% overrange)	Scale Factor	Notes
Off	0 V		
Screen Video	0 – 1 V open circuit	10%/division	8566 compatible
Log Video	0 – 1 V terminated	1/(192.66 dB/V)	dB referenced to mixer level, 1V out for -10 dBm at the mixer.
Linear Video	0 – 1 V terminated	100%/V	Linear referenced to Ref Level, 1 V out for RF envelope at the Ref Level.
Demod Audio	(varies with analyzer setting)		

Auto

Selects the Auto state for the Analog Output menu. In this state, the Analog Output will automatically be set to the most sensible setting for the current mode or measurement.

If you make a selection manually from the Analog Out menu, this selection will remain in force until you change it (or re-select Auto), even if you go to a mode or measurement for which the selected output does not apply.

Key Path	Input/Output, Output Config, Analog Out
Remote Command	OUTPut:ANALog:AUTO OFF ON 0 1

	OUTPut : ANALog : AUTO?
Example	OUTP:ANAL:AUTO ON
Preset	ON
State Saved	Saved in Input/Output State
Initial S/W Revision	A.04.00

Off

Turns off the analog output.

Key Path	Input/Output, Output Config, Analog Out
Example	OUTP:ANAL OFF ! causes the analog output to be off
Readback Text	Off
Initial S/W Revision	A.04.00

(Undefined variable: Primary.ProductName)
IQ Analyzer Mode Reference

5 Mode Functions

Mode

The Mode key allows you to select the available measurement applications or “Modes”. Modes are a collection of measurement capabilities packaged together to provide an instrument personality that is specific to your measurement needs. Each application software product is ordered separately by Model Number and must be licensed to be available. Once an instrument mode is selected, only the commands that are valid for that mode can be executed.

NOTE

Key operation can be different between modes. The information displayed in Help is about the current mode.

To access Help for a different Mode you must first exit Help (by pressing the Cancel (Esc) key). Then select the desired mode and re-access Help.

For more information on Modes, preloading Modes, and memory requirements for Modes, see ["More Information" on page 143](#)

Key Path	Front-panel key
Remote Command	:INSTrument[:SElect] SA RTSA SEQAN EMI BASIC WCDMA EDGE GSM WIMAXOFDMA VSA PNOISE NFIGure ADEMOD BTooth TDSCDMA CDMA2K CDMA1XEV LTE LTE TDD LTEAFDD LTEATDD MSR DVB DTMB DCTV ISDBT CMMB WLAN CWLAN CWIMAXOFDM WIMAXFIXED IDEN RLC SCPI LC VSA89601 :INSTrument[:SElect] ?
Example	:INST SA
Notes	The available parameters are dependent upon installed and licensed applications resident in the instrument. Parameters given here are an example, specific parameters are in the individual Application. A list of the valid mode choices is returned with the INST:CAT? Query.
Preset	This is unaffected by a Preset but is set on a “Restore System Defaults->All” to:
State Saved	Saved in instrument state
Backwards Compatibility SCPI	:INSTrument[:SElect] GSM provided for backwards compatibility. Mapped to EDGE GSM.
Backwards Compatibility SCPI	:INSTrument[:SElect] SANalyzer provided for ESU compatibility. When this command is received, the analyzer aliases it to the following: INST:SEL SCPI LC This results in the analyzer being placed in SCPI Language Compatibility Mode, in order to emulate the ESU Spectrum Analyzer Mode.
Backwards Compatibility SCPI	:INSTrument[:SElect] REceiver provided for ESU compatibility. When this command is received, the analyzer aliases it to the following: :INST:SEL EMI :CONF FSC

	This results in the analyzer being placed in the EMI Receiver Mode, running the Frequency Scan measurement, in order to emulate the ESU Receiver Mode.
Initial S/W Revision	Prior to A.02.00
Modified at S/W Revision	A.13.00
Example	:INST 'SA'
Notes	The query is not a quoted string. It is an enumeration as indicated in the Instrument Select table above. The command must be sequential: i.e. continued parsing of commands cannot proceed until the instrument select is complete and the resultant SCPI trees are available.
Backwards Compatibility SCPI	:INSTrument[:SElect] 'SA' 'PNOISE' 'EDGE' 'GSM' 'BASIC'
Initial S/W Revision	Prior to A.02.00

More Information

The Mode name appears on the banner after the word “Keysight” followed by the Measurement Title. For example, for the IQ Analyzer mode with the Complex Spectrum measurement running:

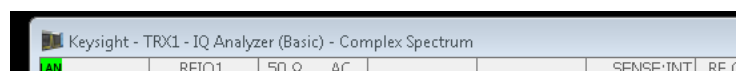

It is possible to specify the order in which the Modes appear in the Mode menu, using the Configure Applications utility (**System, Power On, Configure Applications**). It is also possible, using the same utility, to specify a subset of the available applications to load into memory at startup time, which can significantly decrease the startup time of the analyzer. During runtime, if an application that is not loaded into memory is selected (by either pressing that applications Mode key or sending that applications :INST:SEL command over SCPI), there will be a pause while the Application is loaded. During this pause a message box that says “Loading application, please wait...” is displayed.

Each application (Mode) that runs in the X-Series signal analyzers consumes virtual memory. The various applications consume varying amounts of virtual memory, and as more applications run, the memory consumption increases. Once an application is run, some of its memory remains allocated even when it is not running, and is not released until the analyzer program (xSA.exe) is shut down.

Keysight characterizes each Mode and assigns a memory usage quantity based on a conservative estimate. There is a limited amount of virtual memory available to applications (note that this is virtual memory and is independent of how much physical RAM is in the instrument). The instrument keeps track of how much memory is being used by all loaded applications – which includes those that preloaded at startup, and all of those that have been run since startup.

When you request a Mode that is not currently loaded, the instrument looks up the memory estimate for that Mode, and adds it to the residual total for all currently loaded Modes. If there is not enough virtual memory to load the Mode, a dialog box and menu will appear that gives you four options:

1. Close and restart the analyzer program without changing your configured preloads. This may free up enough memory to load the requested Mode, depending on your configured preloads
2. Clear out all preloads and close and restart the analyzer program with only the requested application preloaded, and with that application running. This choice is guaranteed to allow you to run the requested application; but you will lose your previously configured preloads. In addition, there may be little or no room for other applications, depending on the size of the requested application.
3. Bring up the Configure Applications utility in order to reconfigure the preloaded apps to make room for the applications you want to run (this will then require restarting the analyzer program with your new configuration). This is the recommended choice because it gives you full flexibility to select exactly what you want.
4. Exit the dialog box without doing anything, which means you will be unable to load the application you requested.

In each case except 4, this will cause the analyzer software to close, and you will lose all unsaved traces and results.

If you attempt to load a mode via SCPI that will exceed memory capacity, the Mode does not load and an error message is returned:

```
-225, "Out of memory;Insufficient resources to load Mode (mode name) "
```

where "mode name" is the SCPI parameter for the Mode in question, for example, SA for Spectrum Analyzer Mode.

Sequence Analyzer

Selects the Sequence Analyzer mode for sequenced measurements. Depending on licensed applications there may be a number of different measurements available in this mode. These measurements are all done on IQ captured data and can be set up to calculated on any part of the capture.

If you are using the Help feature, this mode must be currently active to access its detailed information. If it is not active, exit the Help feature (Esc key), select the mode, and re-access Help.

Key Path	Mode
Example	INST:SEL SEQAN INST:NSEL 400
Initial S/W Revision	A.05.01

IQ Analyzer (Basic)

The IQ Analyzer Mode makes general purpose frequency domain and time domain measurements. These measurements often use alternate hardware signal paths when compared with a similar measurement in the Signal Analysis Mode using the Swept SA measurement. These frequency domain and time domain measurements can be used to output I/Q data results when measuring complex modulated digital signals.

If you are using the Help feature, this mode must be currently active to access its detailed information. If it is not active, exit the Help feature (Esc key), select the mode, and re-access Help.

Key Path	Mode
Example	INST:SEL BASIC INST:NSEL 8
Initial S/W Revision	Prior to A.02.00

W-CDMA with HSPA+

Selects the W-CDMA with HSPA+ mode for general purpose measurements of signals following this standard. There are several measurements available in this mode.

If you are using the Help feature, this mode must be currently active to access its detailed information. If it is not active, exit the Help feature (Esc key), select the mode, and re-access Help.

Key Path	Mode
Example	INST:SEL WCDMA INST:NSEL 9
Initial S/W Revision	Prior to A.02.00

GSM/EDGE/EDGE Evo

Selects the GSM with EDGE mode for general purpose measurements of signals following this standard. There are several measurements available in this mode.

If you are using the Help feature, this mode must be currently active to access its detailed information. If it is not active, exit the Help feature (Esc key), select the mode, and re-access Help.

Key Path	Mode
Example	INST:SEL EDGEGSM INST:NSEL 13
Initial S/W Revision	Prior to A.02.00
Modified at S/W Revision	A.02.00

TD-SCDMA with HSPA/8PSK

Selects the TD-SCDMA mode for general purpose measurements of signals following this standard. There are several measurements available in this mode.

If you are using the Help feature, this mode must be currently active to access its detailed information. If it is not active, exit the Help feature (Esc key), select the mode, and re-access Help.

Key Path	Mode
Example	INST:SEL TDSCDMA

	INST:NSEL 211
Initial S/W Revision	Prior to A.02.00

WLAN

Selects the WLAN mode for general purpose measurements of signals following this standard. There are several measurements available in this mode.

If you are using the Help feature, this mode must be currently active to access its detailed information. If it is not active, exit the Help feature (Esc key), select the mode, and re-access Help.

Key Path	Mode
Example	INST:SEL WLAN INST:NSEL 217
Initial S/W Revision	A.09.491

89601 VSA

Selecting the 89601 VSA mode will start the 89600 VSA software. The 89600 VSA software is powerful, PC-based software, offering the industry's most sophisticated general purpose and standards specific signal evaluation and troubleshooting tools for R&D engineers. Even for proprietary and non-standard signals in SATCOM or MILCOM applications, you can make signal quality measurements with customized IQ constellation. Reach deeper into signals, gather more data on signal problems, and gain greater insight.

- Over 35 general-purpose analog and digital demodulators ranging from 2FSK to 4096QAM
- Flexible and custom IQ and OFDM signal analysis for single carrier
- Standards specific modulation analysis including:
 - Cellular: GSM/EDGE, cdma2000, W-CDMA, TD-SCDMA, LTE(FDD/TDD),
 - LTE-Advanced and more
 - Wireless networking: 802.11a/b/g, 802.11n, 802.ac, 802.16 WiMAX (fixed/mobile), WiSUN (MR-FSK PHY)
 - RFID
 - Digital satellite video and other satellite signals, radar, LMDS
 - Up to 400K bin FFT, for the highest resolution spectrum analysis
 - A full suite of time domain analysis tools, including signal capture and playback, time gating, and CCDF measurements
 - 20 simultaneous trace displays and the industry's most complete set of marker functions
 - Easy-to-use Microsoft Windows graphical user interface

For more information see the Keysight 89600 Series VSA web site at www.keysight.com/find/89600vsa

To learn more about how to use the 89600 VSA running in the X-Series, after the 89600 VSA software is running, open the 89600 VSA Help and open the "About Keysight X-Series Signal Analyzer with 89600 VSA Software" help topic.

Key Path	Mode
Example	INST:SEL VSA89601 INST:NSEL 101
Initial S/W Revision	Prior to A.02.00

LTE

Selects the LTE mode for general purpose measurements of signals following the LTE FDD standard. There are several measurements available in this mode.

If you are using the Help feature, this mode must be currently active to access its detailed information. If it is not active, exit the Help feature (Esc key), select the mode, and re-access Help.

Key Path	Mode
Example	INST:SEL LTE INST:NSEL 102
Initial S/W Revision	Prior to A.02.00

LTE TDD

Selects the LTE TDD mode for general purpose measurements of signals following the LTE TDD standard. There are several measurements available in this mode.

If you are using the Help feature, this mode must be currently active to access its detailed information. If it is not active, exit the Help feature (Esc key), select the mode, and re-access Help.

Key Path	Mode
Example	INST:SEL LTETDD INST:NSEL 105
Initial S/W Revision	A.03.00

Application Mode Number Selection (Remote Command Only)

Select the measurement mode by its mode number. The actual available choices depend upon which applications are installed in your instrument. The modes appear in this table in the same order they appear in the Mode menu (if the order is not changed by the Configure Applications utility found in the **System, Power On** menu). See "[Detailed List of Modes](#)" on page 152 for Mode details.

The Mode Number is the parameter for use with the :INSTrument:NSElect command. The Mode Parameter is the parameter for use with the :INSTrument[:SElect] command.

Mode	Mode Number	Mode Parameter
Sequence Analyzer	400	SEQAN
I/Q Analyzer (Basic)	8	BASIC
WCDMA with HSPA+	9	WCDMA
GSM/EDGE/EDGE Evo	13	EDGE GSM
Analog Demod	234	ADEMODO
Bluetooth	228	BT00th
TD-SCDMA with HSPA/8PSK	211	TDSCDMA
cdma2000	10	CDMA2K
1xEV-DO	15	CDMA1XEV
LTE	102	LTE
LTE TDD	105	LTETDD
LTE-Advanced FDD	107	LTEAFDD
LTE-Advanced TDD	108	LTEATDD
WLAN	217	WLAN
802.16 OFDM (Fixed WiMAX)	104	WIMAXFIXED

Remote Command	:INSTRUMENT:NSELECT <integer> :INSTRUMENT:NSELECT?
Example	:INST:NSEL 1
Notes	SA mode is 1 The command must be sequential: i.e. continued parsing of commands cannot proceed until the instrument select is complete and the resultant SCPI trees are available.
Preset	Not affected by Preset. Set to default mode (1 for SA mode) following Restore System Defaults.
State Saved	Saved in instrument state
Initial S/W Revision	Prior to A.02.00

Application Mode Catalog Query (Remote Command Only)

Returns a string containing a comma separated list of names of all the installed and licensed measurement modes (applications). These names can only be used with the :INSTRUMENT[:SELECT] command.

Remote Command	:INSTRUMENT:CATALOG?
Example	:INST:CAT?

Notes	Query returns a quoted string of the installed and licensed modes separated with a comma. Example: "SA,PNOISE,WCDMA"
Backwards Compatibility Notes	VSA (E4406A) :INSTRument:CATalog? returned a list of installed INSTRument:SELECT items as a comma separated list of string values: "BASIC","GSM","EDGE GSM","CDMA","NADC","PDC","WCDMA","CDMA2K","CDMA1XEV","IDEN","WIDEN","WLAN","SERVICE" X-Series uses the ESA/PSA compatible query of a string contain comma separated values: "SA,PNOISE,NFIGURE,BASIC,CDMA,CDMA2K,WCDMA,CDMA1XEV,EDGE GSM,GSM,NADC,PDC,TDSCDMA,DMODULATION,WLAN"
Initial S/W Revision	Prior to A.02.00

Application Identification (Remote Commands Only)

Each entry in the Mode Menu will have a Model Number and associated information: Version, and Options. This information is displayed in the Show System screen. The corresponding SCPI remote commands are defined here.

["Current Application Model " on page 149](#)

["Current Application Revision" on page 149](#)

["Current Application Options" on page 150](#)

Current Application Model

Returns a string that is the Model Number of the currently selected application (mode).

Remote Command	:SYSTem:APPLication[:CURRent][:NAME]?
Example	:SYST:APPL?
Notes	Query returns a quoted string that is the Model Number of the currently selected application (Mode). Example: "N9060A" String length is 6 characters.
Preset	Not affected by Preset
State Saved	Not saved in state, the value will be the selected application when a Save is done.
Initial S/W Revision	Prior to A.02.00

Current Application Revision

Returns a string that is the Revision of the currently selected application (mode).

Remote Command	:SYSTem:APPLication[:CURRent]:REVision?
-----------------------	---

Example	:SYST:APPL:REV?
Notes	Query returns a quoted string that is the Revision of the currently selected application (Mode). Example: "1.0.0.0" String length is a maximum of 23 characters. (each numeral can be an integer + 3 decimal points)
Preset	Not affected by a Preset
State Saved	Not saved in state, the value will be the selected application when a Save is done.
Initial S/W Revision	Prior to A.02.00

Current Application Options

Returns a string that is the Options list of the currently selected application (Mode).

Remote Command	:SYSTem:APPLication[:CURRent]:OPTion?
Example	:SYST:APPL:OPT?
Notes	Query returns a quoted string that is the Option list of the currently selected application (Mode). The format is the name as the *OPT? or SYSTem:OPTion command: a comma separated list of option identifiers. Example: "1FP,2FP" String length is a maximum of 255 characters.
Preset	Not affected by a Preset
State Saved	Not saved in state per se, the value will be the selected application when a Save is invoked.
Initial S/W Revision	Prior to A.02.00

Application Identification Catalog (Remote Commands Only)

A catalog of the installed and licensed applications (Modes) can be queried for their identification.

["Application Catalog Number of Entries" on page 150](#)

["Application Catalog Model Numbers" on page 151](#)

["Application Catalog Revision" on page 151](#)

["Application Catalog Options" on page 151](#)

Application Catalog Number of Entries

Returns the number of installed and licensed applications (Modes).

Remote Command	:SYSTem:APPLication:CATalog[:NAME]:COUNT?
Example	:SYST:APPL:CAT:COUN?

Preset	Not affected by Preset
State Saved	Not saved in instrument state.
Initial S/W Revision	Prior to A.02.00

Application Catalog Model Numbers

Returns a list of Model Numbers for the installed and licensed applications (Modes).

Remote Command	:SYSTem:APPLication:CATalog[:NAME]?
Example	:SYST:APPL:CAT?
Notes	Returned value is a quoted string of a comma separated list of Model Numbers. Example, if SAMS and Phase Noise are installed and licensed: "N9060A,N9068A" String length is COUNT * 7 - 1. (7 = Model Number length + 1 for comma. -1 = no comma for the 1st entry.)
Preset	Not affected by a Preset
State Saved	Not saved in instrument state.
Initial S/W Revision	Prior to A.02.00

Application Catalog Revision

Returns the Revision of the provided Model Number.

Remote Command	:SYSTem:APPLication:CATalog:REvIson? <model>
Example	:SYST:APPL:CAT:REV? 'N9060A'
Notes	Returned value is a quoted string of revision for the provided Model Number. The revision will be a null-string ("") if the provided Model Number is not installed and licensed. Example, if SAMS is installed and licensed: "1.0.0.0"
Preset	Not affected by a Preset.
State Saved	Not saved in instrument state.
Initial S/W Revision	Prior to A.02.00

Application Catalog Options

Returns a list of Options for the provided Model Number

Remote Command	:SYSTem:APPLication:CATalog:OPTion? <model>
Example	:SYST:APPL:CAT:OPT? 'N9060A'

Notes	Returned value is a quoted string of a comma separated list of Options, in the same format as *OPT? or :SYSTem:OPTion?. If the provided Model Number is not installed and licensed a null-string ("") will be returned. Example, if SAMS is installed and licensed: "2FP" String length is a maximum of 255 characters.
Preset	Not affected by a Preset
State Saved	Not saved in instrument state.
Initial S/W Revision	Prior to A.02.00

Detailed List of Modes

This section contains an alphabetical list of Modes available in the X-Series, along with a brief description of each Mode.

89601 VSA

Selecting the 89601 VSA mode will start the 89600 VSA software. The 89600 VSA software is powerful, PC-based software, offering the industry's most sophisticated general purpose and standards specific signal evaluation and troubleshooting tools for R&D engineers. Even for proprietary and non-standard signals in SATCOM or MILCOM applications, you can make signal quality measurements with customized IQ constellation. Reach deeper into signals, gather more data on signal problems, and gain greater insight.

- Over 35 general-purpose analog and digital demodulators ranging from 2FSK to 4096QAM
- Flexible and custom IQ and OFDM signal analysis for single carrier
- Standards specific modulation analysis including:
 - Cellular: GSM/EDGE, cdma2000, W-CDMA, TD-SCDMA, LTE(FDD/TDD),
 - LTE-Advanced and more
 - Wireless networking: 802.11a/b/g, 802.11n, 802.ac, 802.16 WiMAX (fixed/mobile), WiSUN (MR-FSK PHY)
 - RFID
 - Digital satellite video and other satellite signals, radar, LMDS
 - Up to 400K bin FFT, for the highest resolution spectrum analysis
 - A full suite of time domain analysis tools, including signal capture and playback, time gating, and CCDF measurements
 - 20 simultaneous trace displays and the industry's most complete set of marker functions
 - Easy-to-use Microsoft Windows graphical user interface

For more information see the Keysight 89600 Series VSA web site at www.keysight.com/find/89600vsa

To learn more about how to use the 89600 VSA running in the X-Series, after the 89600 VSA software is running, open the 89600 VSA Help and open the "About Keysight X-Series Signal Analyzer with 89600 VSA Software" help topic.

Key Path	Mode
Example	INST:SEL VSA89601 INST:NSEL 101
Initial S/W Revision	Prior to A.02.00

GSM/EDGE/EDGE Evo

Selects the GSM with EDGE mode for general purpose measurements of signals following this standard. There are several measurements available in this mode.

If you are using the Help feature, this mode must be currently active to access its detailed information. If it is not active, exit the Help feature (Esc key), select the mode, and re-access Help.

Key Path	Mode
Example	INST:SEL EDGEGSM INST:NSEL 13
Initial S/W Revision	Prior to A.02.00
Modified at S/W Revision	A.02.00

IQ Analyzer (Basic)

The IQ Analyzer Mode makes general purpose frequency domain and time domain measurements. These measurements often use alternate hardware signal paths when compared with a similar measurement in the Signal Analysis Mode using the Swept SA measurement. These frequency domain and time domain measurements can be used to output I/Q data results when measuring complex modulated digital signals.

If you are using the Help feature, this mode must be currently active to access its detailed information. If it is not active, exit the Help feature (Esc key), select the mode, and re-access Help.

Key Path	Mode
Example	INST:SEL BASIC INST:NSEL 8
Initial S/W Revision	Prior to A.02.00

LTE

Selects the LTE mode for general purpose measurements of signals following the LTE FDD standard. There are several measurements available in this mode.

If you are using the Help feature, this mode must be currently active to access its detailed information. If it is not active, exit the Help feature (Esc key), select the mode, and re-access Help.

Key Path	Mode
Example	INST:SEL LTE INST:NSEL 102
Initial S/W Revision	Prior to A.02.00

LTE TDD

Selects the LTE TDD mode for general purpose measurements of signals following the LTE TDD standard. There are several measurements available in this mode.

If you are using the Help feature, this mode must be currently active to access its detailed information. If it is not active, exit the Help feature (Esc key), select the mode, and re-access Help.

Key Path	Mode
Example	INST:SEL LTETDD INST:NSEL 105
Initial S/W Revision	A.03.00

LTE-Advanced FDD

As LTE-Advanced FDD and LTE modes are converged into one single application, the single softkey under Mode menu is designed to select the covered mode. The display mode of the LTE and LTE-Advanced FDD are distinguished by the licenses.

If you are using the Help feature, this mode must be currently active to access its detailed information. If it is not active, exit the Help feature (Esc key), select the mode, and re-access Help.

Key Path	Mode
Example	INST:SEL LTEAFDD INST:NSEL 107
Notes	When the N9080A/80B-1FP exists, the display mode name is LTE. When the N9080A/80B-1FP and N9080B-2FP all exist, the display mode name is LTE FDD & LTE-A FDD.
Backwards Compatibility SCPI	INST:SEL LTE INST:NSEL 102
Initial S/W Revision	A.14.00
Modified at S/W Revision	A.14.50

LTE-Advanced TDD

As LTE-Advanced TDD and LTE TDD modes are converged into one single application, the single softkey under Mode menu is designed to select the covered mode. The display mode of the LTE TDD and LTE-Advanced TDD are distinguished by the licenses.

If you are using the Help feature, this mode must be currently active to access its detailed information. If it is not active, exit the Help feature (Esc key), select the mode, and re-access Help.

Key Path	Mode
Example	INST:SEL LTEATDD INST:NSEL 108
Notes	When the N9082A/82B-1FP exists, the display mode name is LTE TDD. When the N9082A/82B-1FP and N9082B-2FP all exist, the display mode name is LTE TDD & LTE-A TDD.
Backwards Compatibility SCPI	INST:SEL LTETDD INST:NSEL 105
Initial S/W Revision	A.14.00
Modified at S/W Revision	A.14.50

Sequence Analyzer

Selects the Sequence Analyzer mode for sequenced measurements. Depending on licensed applications there may be a number of different measurements available in this mode. These measurements are all done on IQ captured data and can be set up to calculated on any part of the capture.

If you are using the Help feature, this mode must be currently active to access its detailed information. If it is not active, exit the Help feature (Esc key), select the mode, and re-access Help.

Key Path	Mode
Example	INST:SEL SEQAN INST:NSEL 400
Initial S/W Revision	A.05.01

TD-SCDMA with HSPA/8PSK

Selects the TD-SCDMA mode for general purpose measurements of signals following this standard. There are several measurements available in this mode.

If you are using the Help feature, this mode must be currently active to access its detailed information. If it is not active, exit the Help feature (Esc key), select the mode, and re-access Help.

Key Path	Mode
Example	INST:SEL TDSCDMA INST:NSEL 211

Initial S/W Revision	Prior to A.02.00
----------------------	------------------

W-CDMA with HSPA+

Selects the W-CDMA with HSPA+ mode for general purpose measurements of signals following this standard. There are several measurements available in this mode.

If you are using the Help feature, this mode must be currently active to access its detailed information. If it is not active, exit the Help feature (Esc key), select the mode, and re-access Help.

Key Path	Mode
Example	INST:SEL WCDMA INST:NSEL 9
Initial S/W Revision	Prior to A.02.00

WLAN

Selects the WLAN mode for general purpose measurements of signals following this standard. There are several measurements available in this mode.

If you are using the Help feature, this mode must be currently active to access its detailed information. If it is not active, exit the Help feature (Esc key), select the mode, and re-access Help.

Key Path	Mode
Example	INST:SEL WLAN INST:NSEL 217
Initial S/W Revision	A.09.491

Global Settings

Opens a menu that allows you to switch certain Meas Global parameters to a Mode Global state. These switches apply to all Modes that support global settings. No matter what Mode you are in when you set the “Global Center Frequency” switch to on, it applies to all Modes that support Global Settings.

Key Path	Mode Setup
Initial S/W Revision	Prior to A.02.00

Global Center Freq

The software maintains a Mode Global value called “Global Center Freq”.

When the **Global Center Freq** key is switched to **On** in any mode, the current mode’s center frequency is copied into the Global Center Frequency, and from then on all modes that support global settings use the

Global Center Frequency. So you can switch between any of these modes and the Center Freq will remain unchanged.

Adjusting the Center Freq of any mode which supports Global Settings, while **Global Center Freq** is **On**, will modify the Global Center Frequency.

When **Global Center Freq** is turned **Off**, the Center Freq of the current mode is unchanged, but now the Center Freq of each mode is once again independent.

When **Mode Preset** is pressed while **Global Center Freq** is **On**, the Global Center Freq is preset to the preset Center Freq of the current mode.

This function is reset to Off when the Restore Defaults key is pressed in the Global Settings menu, or when **System, Restore Defaults, All Modes** is pressed.

Key Path	Mode Setup, Global Settings
Scope	Mode Global
Remote Command	:INSTrument:COUPle:FREQuency:CENTer ALL NONE :INSTrument:COUPle:FREQuency:CENTer?
Example	INST:COUP:FREQ:CENT ALL INST:COUP:FREQ:CENT?
Preset	Set to Off on Global Settings, Restore Defaults and System, Restore Defaults, All Modes
Range	On Off
Initial S/W Revision	Prior to A.02.00

Remote Command	:GLOBal:FREQuency:CENTer[:STATe] 1 0 ON OFF :GLOBal:FREQuency:CENTer[:STATe]?
Preset	Off
Initial S/W Revision	Prior to A.02.00

Restore Defaults

This key resets all of the functions in the Global Settings menu to Off. This also occurs when **System, Restore Defaults, All Modes** is pressed.

Key Path	Mode Setup, Global Settings
Remote Command	:INSTrument:COUPle:DEFault
Example	INST:COUP:DEF
Backwards Compatibility SCPI	:GLOBal:DEFault
Initial S/W Revision	Prior to A.02.00

Mode Setup

Opens a menu that enables you to select Mode Setup parameters.

Key Path	Front-panel key
Initial S/W Revision	Prior to A.02.00

Restore Mode Defaults

Resets the state for the currently active mode by resetting the mode persistent settings to their factory default values, clearing mode data and by performing a Mode Preset. This function will never cause a mode switch. This function performs a full preset for the currently active mode; whereas, Mode Preset performs a partial preset. Restore Mode Defaults does not affect any system settings. System settings are reset by the Restore System Defaults function. This function does reset mode data; as well as settings.

Key Path	Mode Setup
Remote Command	:INSTrument:DEFault
Example	:INST:DEF
Notes	Clears all pending OPC bits. The Status Byte is set to 0. A message comes up saying: "If you are sure, press key again".
Couplings	A Restore Mode Defaults will cause the currently running measurement to be aborted and causes the default measurement to be active. It gets the mode to a consistent state with all of the default couplings set.
Initial S/W Revision	Prior to A.02.00

Preset Type (Remote Command Only)

As stated in the Backward Compatibility section, to be compatible with ESA/PSA the PRESet:TYPE command will be implemented as a no-op.

Mode	All
Remote Command	:SYSTem:PRESet:TYPE FACTory MODE USER :SYSTem:PRESet:TYPE?
Example	:SYST:PRESet:TYPE FACT
Notes	This command is supported for backward compatibility only. It is a no-op which does not change the behavior of any preset operation.
Preset	This is unaffected by Preset but is set to Mode on a "Restore System Defaults->All"
State Saved	No
Initial S/W Revision	Prior to A.02.00

(Undefined variable: Primary.ProductName)
IQ Analyzer Mode Reference

6 System Functions

File

Opens a menu that enables you to access various standard and custom Windows functions. Press any other front-panel key to exit

Key Path	Front-panel key
Initial S/W Revision	Prior to A.02.00

File Explorer

Opens the standard Windows File Explorer. The File Explorer opens in the My Documents directory for the current user.

The File Explorer is a separate Windows application, so to return to the analyzer once you are in the File Explorer, you may either:

Exit the File Explorer by clicking on the red X in the upper right corner, with a mouse

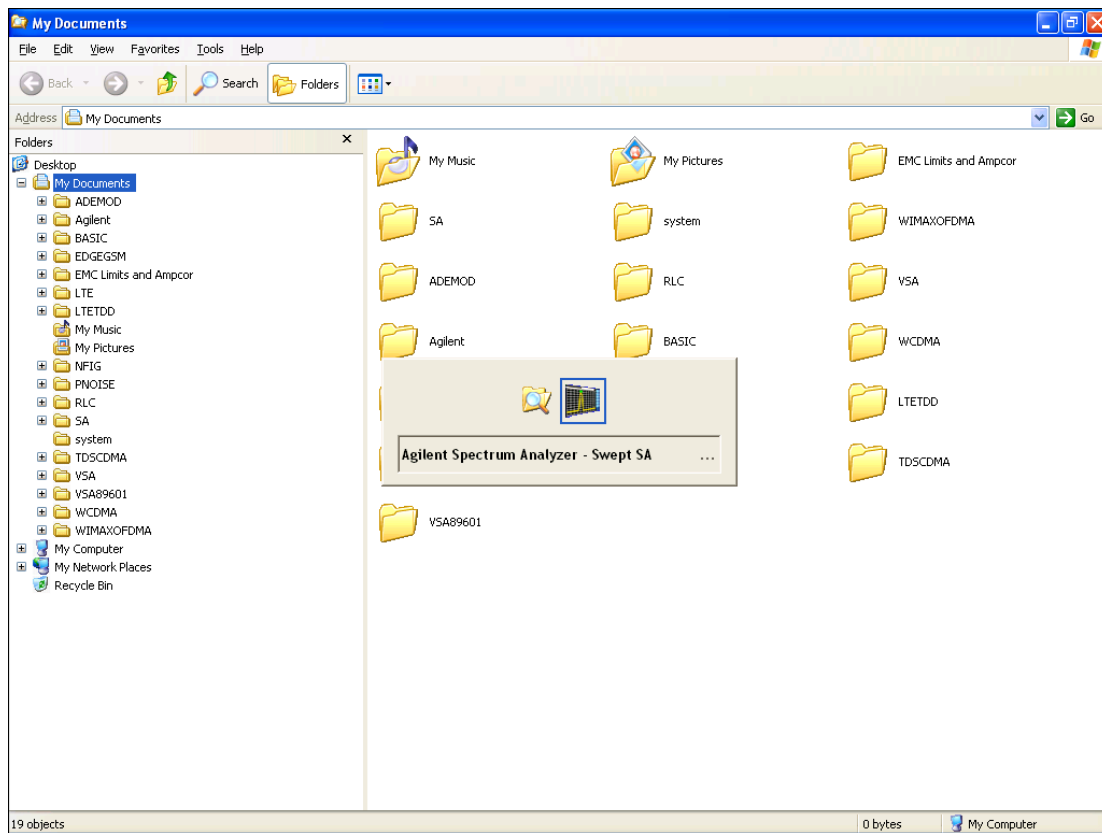

Or use Alt-Tab: press and hold the Alt key and press and release the Tab key until the Analyzer logo is showing in the window in the center of the screen, as shown above, then release the Alt key.

The ability to access File Explorer is not available if Option SF1 is installed.

Key Path	File
Initial S/W Revision	Prior to A.02.00

Print

The Print key opens a Print dialog for configured printing (for example, to the printer of your choice). Refer to your Microsoft Windows Operating System manual for more information.

Maximize/Restore Down

These keys allow the Instrument Application to be maximized and then restored to its prior state. Only one of the two keys is visible at a time. When not already maximized the Maximize Application key is visible, and when maximized, the Restore Down Application key is visible and replaces the Maximize Application key.

Maximize

This key allows you to Maximize the Instrument Application, which causes the analyzer display to fill the screen. Once the application is maximized, this key is replaced by the Restore Down key.

Key Path	File
Mode	All
Notes	No equivalent remote command for this key.
State Saved	No
Initial S/W Revision	A.05.01

Restore Down

This key allows you to Restore Down the Instrument Application and reverses the action taken by Maximize. This key is only visible when the application has been maximized, and after the Restore Down action has been completed this key is replaced by the Maximize key.

Key Path	File
Mode	All
Notes	No equivalent remote command for this key.
State Saved	No
Initial S/W Revision	A.05.01

Page Setup

The Page Setup key brings up a Windows Page Setup dialog that allows you to control aspects of the pages sent to the printer when the PRINT hardkey is pressed.

Key Path	File
Initial S/W Revision	Prior to A.02.00

Paper size, the printer paper source, the page orientation and the margins are all settable. Just like any standard Windows dialog, you may navigate the dialog using the front-panel keys, or a mouse. There are no SCPI commands for controlling these parameters.

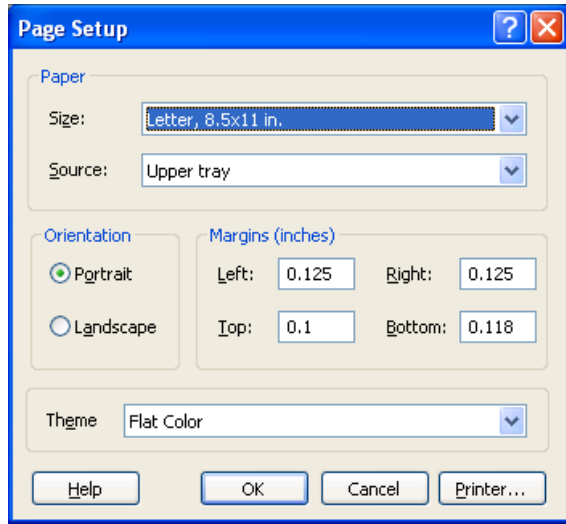

Also contained in this dialog is a drop-down control that lets you select the Theme to use when printing. For more on Themes, see information under View/Display, Display, System Display Settings, Theme. The Theme control has a corresponding SCPI command.

Parameter Name	Print Themes
Parameter Type	Enum
Mode	All
Remote Command	:SYSTEM:PRINT:THEME TDCOLOR TDMONOCHROME FCOLOR FMONOCHROME :SYSTEM:PRINT:THEME?
Example	:SYST:PRIN:THEM FCOL
Setup	:SYSTem:DEFault MISC
Preset	FCOL; not part of Preset, but is reset by Restore Misc Defaults or Restore System Defaults All and survives subsequent running of the modes.
State Saved	No
Initial S/W Revision	Prior to A.02.00

Print

This front-panel key is equivalent to performing a File, Print, OK. It immediately performs the currently configured Print to the Default printer.

The :HCOPY command is equivalent to pressing the PRINT key. The HCOPY:ABORT command can be used to abort a print which is already in progress. Sending HCOPY:ABORT will cause the analyzer to stop sending data to the printer, although the printer may continue or even complete the print, depending on how much data was sent to the printer before the user sent the ABORT command.

Key Path	Front-panel key
Remote Command	:HCOPY[:IMMEDIATE]
Initial S/W Revision	Prior to A.02.00

Key Path	SCPI command only
Remote Command	:HCOPY:ABORT
Initial S/W Revision	Prior to A.02.00

Restore Down

This key allows you to Restore Down the Instrument Application and reverses the action taken by Maximize. This key is only visible when the application has been maximized, and after the Restore Down action has been completed this key is replaced by the Maximize key.

Key Path	File
Mode	All
Notes	No equivalent remote command for this key.
State Saved	No
Initial S/W Revision	A.05.01

Minimize

The Minimize key causes the analyzer display to disappear down into the task bar, allowing you to see the

Windows Desktop. You can use Alt-Tab (press and hold the Alt  key and press and release the Tab key) to restore the analyzer display.

Key Path	File
Mode	All
Notes	No equivalent remote command for this key.
State Saved	No
Initial S/W Revision	A.05.01

Exit

This key, when pressed, will exit the Instrument Application. A dialog box is used to confirm that you intended to exit the application:

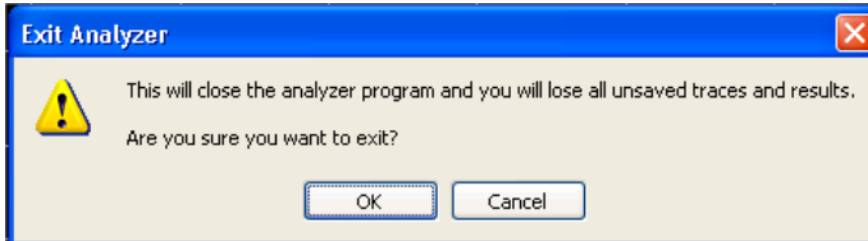

Key Path	File
Mode	All
Notes	The Instrument Application will close. No further SCPI commands can be sent. Use with caution!
Initial S/W Revision	Prior to A.02.00

Print

This front-panel key is equivalent to performing a File, Print, OK. It immediately performs the currently configured Print to the Default printer.

The :HCOPY command is equivalent to pressing the PRINT key. The HCOPY:ABORT command can be used to abort a print which is already in progress. Sending HCOPY:ABORT will cause the analyzer to stop sending data to the printer, although the printer may continue or even complete the print, depending on how much data was sent to the printer before the user sent the ABORT command.

Key Path	Front-panel key
Remote Command	:HCOPY[:IMMEDIATE]
Initial S/W Revision	Prior to A.02.00

Key Path	SCPI command only
Remote Command	:HCOPY:ABORT
Initial S/W Revision	Prior to A.02.00

System

Opens a menu of keys that access various configuration menus and dialogs.

Key Path	Front-panel key
Notes	No remote command for this key specifically.
Initial S/W Revision	Prior to A.02.00

Show

Accesses a menu of choices that enable you to select the information window you want to view.

Key Path	System
Mode	All
Remote Command	:SYSTem:SHOW OFF ERRor SYSTem HARDware LXI HWSTatistics ALIGNment SOFTware CAPplication :SYSTem:SHOW?
Example	:SYST:SHOW SYST
Notes	This command displays (or exits) the various System information screens.
Preset	OFF
State Saved	No
Range	OFF ERRor SYSTem HARDware LXI HWSTatistics ALIGNment SOFTware CAPplication
Initial S/W Revision	Prior to A.02.00

Errors

There are two modes for the Errors selection, History and Status.

The list of errors displayed in the Errors screen does not automatically refresh. You must press the Refresh key or leave the screen and return to it to refresh it.

History brings up a screen displaying the event log in chronological order, with the newest event at the top. The history queue can hold up to 100 messages (if a message has a repeat count greater than 1 it only counts once against this number of 100). Note that this count bears no relation to the size of the SCPI queue. If the queue extends onto a second page, a scroll bar appears to allow scrolling with a mouse. Time is displayed to the second.

Status brings up a screen summarizing the status conditions currently in effect. Note that the time is displayed to the second.

The fields on the Errors display are:

Type (unlabeled) - Displays the icon identifying the event or condition as an error or warning.

ID - Displays the error number.

Message - Displays the message text.

Repeat (RPT) - This field shows the number of consecutive instances of the event, uninterrupted by other events. If an event occurs 5 times with no other intervening event, the value of repeat will be 5.

If the value of Repeat is 1 the field does not display. If the value of Repeat is >1, the time and date shown are those of the most recent occurrence. If the value of repeat reaches 999,999 it stops there.

Time - Shows the most recent time (including the date) at which the event occurred.

Key Path	System, Show
Mode	All
Remote Command	:SYSTem:ERRor[:NEXT]?
Example	:SYST:ERR?
Notes	The return string has the format: “<Error Number>,<Error>” Where <Error Number> and <Error> are those shown on the Show Errors screen
Backwards Compatibility Notes	In some legacy analyzers, the Repeat field shows the number of times the message has repeated since the last time the error queue was cleared. In the X-Series, the Repeat field shows the number of times the error has repeated since the last intervening error. So the count may very well be different than in the past even for identical signal conditions Unlike previous analyzers, in the X-Series all errors are reported through the Message or Status lines and are logged to the event queue. They never appear as text in the graticule area (as they sometimes do in previous analyzers) and they are never displayed in the settings panel at the top of the screen (as they sometimes do, by changing color, in previous analyzers). As a consequence of the above, the user can only see one status condition (the most recently generated) without looking at the queue. In the past, at least in the Spectrum Analyzer, multiple status conditions might display on the right side of the graticule. In general, there is no backwards compatibility specified or guaranteed between the error numbers in the X-Series and those of earlier products. Error, event, and status processing code in customers' software will probably need to be rewritten to work with X-Series. In the legacy analyzers, some conditions report as errors and others simply turn on status bits. Conditions that report as errors often report over and over as long as the condition exists. In the X-series, all conditions report as start and stop events. Consequently, software that repeatedly queries for a condition error until it stops reporting will have to be rewritten for the X-series.
Initial S/W Revision	Prior to A.02.00

Previous Page

See ["Next Page" on page 168.](#)

Key Path	System, Show, Errors
Initial S/W Revision	Prior to A.02.00

Next Page

Next Page and Previous Page menu keys move you between pages of the log, if it fills more than one page. These keys are grayed out in some cases:

- If on the last page of the log, the Next Page key is grayed-out
- If on the first page of the log, the Previous Page key is grayed-out.
- If there is only one page, both keys are grayed out.

Key Path	System, Show, Errors
Initial S/W Revision	Prior to A.02.00

History

The History and Status keys select the Errors view. The Status key has a second line that shows a number in [square brackets]. This is the number of currently open status items.

Key Path	System, Show, Errors
Initial S/W Revision	Prior to A.02.00

Verbose SCPI On/Off

When you turn Verbose SCPI on, additional information is returned when you send the :SYSTem:ERRor? query. The additional information consists of the characters that stimulated the error. This can aid you in debugging your test programs by indicating where in the parsing of a SCPI command the instrument encountered an invalid command or query.

Specifically, with Verbose SCPI on, the SYSTem:ERRor? query is expanded to show the SCPI data received, with the indicator <Err> at the point in the stream that the error occurred.

Verbose SCPI has no effect on the Show Errors screen or front panel Message Line; it only changes the response to the :SYST:ERR? query.

See the example below, where the invalid command "SENS:BOGUS" is sent:

Normal response to :SYST:ERR (using the Telnet window):

```
SCPI> SENS:BOGUS
```

```
SCPI> SYST:ERR?
```

```
-113,"Undefined header"
```

Now after turning on Verbose SCPI:

```
SCPI> SYST:BOGUS
```

```
SCPI> SYST:ERR?
```

```
-113,"Undefined header;SYST:BOGUS<Err>"
```

Key Path	System, Show, Errors
Mode	All
Remote Command	:SYSTem:ERRor:VERBose OFF ON 0 1 :SYSTem:ERRor:VERBose?
Example	:SYST:ERR:VERB ON
Preset	This is unaffected by Preset but is set to OFF on a "Restore System Defaults->Misc"
State Saved	No
Range	On Off
Initial S/W Revision	Prior to A.02.00

Refresh

When pressed, refreshes the Show Errors display.

Key Path	System, Show, Errors
Initial S/W Revision	Prior to A.02.00

Clear Error Queue

This clears all errors in all error queues.

Note the following:

- Clear Error Queue does not affect the current status conditions.
- Mode Preset does not clear the error queue.
- Restore System Defaults will clear all error queues.
- *CLS only clears the queue if it is sent remotely and *RST does not affect any error queue.
- Switching modes does not affect any error queues.

Key Path	System, Show, Errors
Initial S/W Revision	Prior to A.02.00

Status

See "[History](#)" on page 168.

Input Overload Enable (Remote Command Only)

Input Overload errors are reported using the Input Overload status bit (bit 12 in the Measurement Integrity status register). Input Overloads (for example, ADC Overload errors) can come and go with great frequency, generating many error events (for example, for signals just on the verge of overload), and so are

not put into the SCPI error queue by default. Normally the status bit is the only way for detecting these errors remotely.

It is possible to enable Input Overload reporting to the SCPI queue, by issuing the :SYSTem:ERRor:OVERload ON command. To return to the default state, issue the :SYSTem:ERRor:OVERload OFF command. In either case, Input Overloads always set the status bit.

NOTE

For versions of firmware before A.10.01, the Input Overload was only a Warning and so was never available in the SCPI queue, although it did set the status bit. For A.10.01 and later, the Input Overload is an error and can be enabled to the SCPI queue using this command.

Key Path	SCPI only
Remote Command	:SYSTem:ERRor:OVERload[:STATe] 0 1 OFF ON
Example	:SYST:ERR:OVER 1 Enable overload errors
Preset	Set to OFF by Restore Misc Defaults (no Overload errors go to SCPI)
State Saved	Saved in instrument state.
Initial S/W Revision	A.10.01

Power Up (Remote Command Only)

This serves to show the errors encountered during the application boot-up, such as: mismatch FW-FPGA, missing Calibration data, missing hardware and construction errors.

Remote Command	:SYSTem:ERRor:PUP?
Notes	<p>If no error occurs, the return value will be: "No Power Up Errors." Return Value: <list of error strings>. <List of error strings> is an <IEEE488 Block> format. Return Value Example: "Power up errors, see details in Windows Event Log" "Unmatched FPGA Version(s), See details in Windows Event Log"</p>
Initial S/W Revision	E.14.30

System

The System screen is formatted into three groupings: product descriptive information, options tied to the hardware, and software products:

<Product Name> <Product Description>		
Product Number: N9020A		
Serial Number: US46220924		
Firmware Revision: A.01.01		
Computer Name: <hostname>		
Host ID: N9020A,US44220924		
N9020A-503	Frequency Range to 3.6 GHz	
N9020A-PFR	Precison Frequency Reference	
N9020A-P03	Preamp 3.6 GHz	
N9060A-2FP	Spectrum Analysis Measurement Suite	1.0.0.0
N9073A-1FP	WCDMA	1.0.0.0
N9073A-2FP	WCDMA with HSDPA	1.0.0.0

The Previous Page is grayed-out if the first page of information is presently displayed. The Next Page menu key is grayed-out if the last page is information is presently displayed.

Key Path	System, Show
Mode	All
Example	SYST:SHOW SYST
Backwards Compatibility Notes	The hardware statistics that are displayed in the PSA Show System screen have been moved to a dedicated Show Hardware Statistics screen in the Service Menu.
Initial S/W Revision	Prior to A.02.00

Show System contents (Remote Command Only)

A remote command is available to obtain the contents of the Show System screen (the entire contents, not just the currently displayed page).

Remote Command	:SYSTem:CONFigure[:SYSTem]?
Example	:SYST:CONF?
Notes	The output is an IEEE Block format of the Show System contents. Each line is separated with a new-line character.
Initial S/W Revision	Prior to A.02.00

Computer System description (Remote Command Only)

A remote command is available to obtain the Computer System description. The Computer System is the operating system and patch level as reported by operating system.

Remote Command	:SYSTem:CSYSem?
Example	:SYST:CSYS?
Notes	The return value is the Computer System name and service pack level.
Initial S/W Revision	Prior to A.12.00

Hardware

The show hardware screen is used to view details of the installed hardware. This information can be used to determine versions of hardware assemblies and field programmable devices, in the advent of future upgrades or potential repair needs.

The screen is formatted into two groupings: product descriptive information and hardware information. The hardware information is listed in a table format:

Hardware Information									
Agilent EXM Wireless Test Set									
Product Number: E6640A									
Serial Number: US12341234									
Instrument S/W Revision: E.14.00_R0133									
Revision Date: 1/23/2014 10:33:35 AM									
Assembly Name	Part #	Serial #	Matl Rev	Rev	OF Rev	Hw Id	Cal Date	Cal Interval	Misc
Reference	M9300A	MY53000146				0165			
Reference Carrier	M9300A	W1312-63281-23-1306-00076		01	1.2.1	0166			
Reference Plugin	M9300A	W1312-63386-30-1306-00038		01	1.3.0	0167			
Wideband Digitizer	M943063005	111111111111	001	0	0	138			
Downconverter	M943063006	111111111111	001	0	A	139			
RFIO	M943063009	111111111111	001	0	A	140			
Power Supply	M943063002	111111111111	001	0	A	141			
M9430 TRX	1234567890	SN12344321	0	0	0	142	2013.10.02	2 years	
Baseband Generator	M943063007	111111111111	002	0	0	136			
ModulatorSrcOutput	M943063008	111111111111	001	0	A	137			

The Previous Page is grayed-out if the first page of information is presently displayed. The Next Page menu key is grayed-out if the last page of information is presently displayed.

Key Path	System, Show
Mode	All
Example	SYST:SHOW HARD
Initial S/W Revision	Prior to A.02.00

System Remote Commands (Remote Commands Only)

The commands in this section have no front-panel key equivalent.

"System Powerdown (Remote Command Only)" on page 173

System Log Off (Remote Command Only)

"List installed Options (Remote Command Only)" on page 173

"Lock the Front-panel keys (Remote Command Only)" on page 173

"List SCPI Commands (Remote Command Only)" on page 174

"SCPI Version Query (Remote Command Only)" on page 174

"Date (Remote Command Only)" on page 174

"Time (Remote Command Only)" on page 175

Initial S/W Revision	Prior to A.02.00
----------------------	------------------

System Powerdown (Remote Command Only)

Remote Command	SYSTem:PDOWn [NORMal FORCe]
-----------------------	-----------------------------

Notes	Shuts down the instrument in the normal way (NORMal) or forced way (FORCe). In case there is another application with modified data pending for saving, the application prompt the user. The system waits until the user responds in the normal mode. It will go off after 20 seconds of wait in the force mode and all data will be lost.
-------	--

List installed Options (Remote Command Only)

Lists the installed options that pertain to the instrument (signal analyzer). .

Mode	All
------	-----

Remote Command	:SYSTem:OPTions?
-----------------------	------------------

Example	:SYST:OPT?
----------------	------------

Notes	The return string is a comma separated list of the installed options. For example: "503,P03,PFR" :SYSTem:OPTions? and *OPT? are the same.
-------	---

State Saved	No
-------------	----

Initial S/W Revision	Prior to A.02.00
----------------------	------------------

Lock the Front-panel keys (Remote Command Only)

Disables the instrument keyboard to prevent local input when the instrument is controlled remotely. Annunciation showing a "K" for "Klock" (keyboard lock) alerts the local user that the keyboard is locked. Klock is similar to the GPIB Local Lockout function; namely that no front-panel keys are active with the exception of the Power Standby key. (The instrument is allowed to be turned-off if Klock is ON.) The Klock command is used in remote control situations where Local Lockout cannot be used.

Although primary intent of Klock is to lock-out the front panel, it will lock-out externally connected keyboards through USB. Klock has no effect on externally connected pointing devices (mice).

The front panel 'Local' key (Cancel/Esc) has no effect if Klock is ON.

Mode	All
Remote Command	:SYSTem:KLOCK OFF ON 0 1 :SYSTem:KLOCK?
Example	:SYST:KLOC ON
Notes	Keyboard lock remains in effect until turned-off or the instrument is power-cycled
Preset	Initialized to OFF at startup, unaffected by Preset
State Saved	No
Initial S/W Revision	Prior to A.02.00

List SCPI Commands (Remote Command Only)

Outputs a list of the valid SCPI commands for the currently selected Mode.

Remote Command	:SYSTem:HELP:HEADers?
Example	:SYST:HELP:HEAD?
Notes	The output is an IEEE Block format with each command separated with the New-Line character (hex 0x0A)
Initial S/W Revision	Prior to A.02.00

SCPI Version Query (Remote Command Only)

Returns the SCPI version number with which the instrument complies. The SCPI industry standard changes regularly. This command indicates the version used when the instrument SCPI commands were defined.

Remote Command	:SYSTem:VERSion?
Example	:SYST:VERS?
Initial S/W Revision	Prior to A.02.00

Date (Remote Command Only)

The recommended access to the Date, Time, and Time zone of the instrument is through the Windows native control (Control Panel or accessing the Task Bar). You may also access this information remotely, as shown in this command and Time (below).

Sets or queries the date in the instrument.

Mode	All
------	-----

Remote Command	:SYSTem:DATE "<year>,<month>,<day>" :SYSTem:DATE?
Example	:SYST:DATE "2006,05,26"
Notes	<year> is the four digit representation of year. (for example, 2006) <month> is the two digit representation of year. (for example. 01 to 12) <day> is the two digit representation of day. (for example, 01 to 28, 29, 30, or 31) depending on the month and year Unless the current account has Power User or Administrator privileges, an error will be generated by this command and no action will be taken.
Initial S/W Revision	Prior to A.02.00

Time (Remote Command Only)

Sets or queries the time in the instrument.

Mode	All
Remote Command	:SYSTem:TIME "<hour>,<minute>,<second>" :SYSTem:TIME?
Example	:SYST:TIME "13,05,26"
Notes	<hour> is the two digit representation of the hour in 24 hour format <minute> is the two digit representation of minute <second> is the two digit representation of second Unless the current account has Power User or Administrator privileges, an error will be generated by this command and no action will be taken.
Initial S/W Revision	Prior to A.02.00

Module Name (Remote Command Only)

Query only. This will return the name of the instance as displayed on the xSA main window.

Mode	All
Remote Command	:SYSTem:MODule:NAME?
Example	:SYST:MOD:NAME?
Notes	If the first instance displays on the xSA main window, the return string is "TRX1". If the second instance displays on the main window, the return string is "TRX2". If the third instance displays on the main window, the return string is "TRX3". If the fourth instance displays on the main window, the return string is "TRX4".
Preset	Not affected by Preset, reset to "Left" with Restore System Defaults Misc.

State Saved	No
Initial S/W Revision	A.13.80

Module Index (Remote Command Only)

Query only. This will return the index of this xSA instance. This index is used as the device number in a VISA address (“hlislip#”).

Mode	All
Remote Command	:SYSTem:MODule:INDex?
Example	:SYST:MOD:IND?
Notes	It returns 0 if this instance’s device number in a VISA address is 0. It returns 1 if this instance’s device number in a VISA address is 1.
Preset	Not affected by Preset, reset to 0 with Restore System Defaults Misc.
State Saved	No
Initial S/W Revision	A.13.80

Module Mnemonic (Remote Command Only)

Query only. This will return the mnemonic of the instance as used in the command line “/Process:<mnemonic>” argument.

Mode	All
Remote Command	:SYSTem:MODule:MNEMonic?
Example	:SYST:MOD:MNEM?
Notes	This will return the mnemonic of the instance as used in the command line “/Process:<mnemonic>” argument.
Preset	Not affected by Preset and Restore System Defaults Misc.
State Saved	No
Initial S/W Revision	A.13.80

Module List (Remote Command Only)

Query only. This will return the list of defined mnemonics that can be used in the command line “/Process:<mnemonic>” argument with corresponding configuration information. The comma separated return values are: mnemonic, display name, Enabled/Disabled, VISA device id (instr# or hislip#), telnet port, socket port, Physics port, Physics configuration tag.

Mode	All
------	-----

Remote Command	:SYSTem:MODule:LIST?
Example	:SYST:MOD:LIST?
Notes	<p>Example:</p> <p>it returns:</p> <p>TRX1,TRX1,Enabled,0,5023,5025,3574,E6650AModules.config#TRX1</p> <p>TRX2,TRX2,Disabled,1,5123,5125,3575,E6650AModules.config#TRX2</p> <p>TRX3,TRX3,Disabled,2,5223,5225,3576,E6650AModules.config#TRX3</p> <p>TRX4,TRX4,Disabled,3,5323,5325,3577,E6650AModules.config#TRX4</p>
Preset	Not affected by Preset, reset to 0 with Restore System Defaults Misc.
State Saved	No
Initial S/W Revision	A.13.80

Module Enable (Remote Command Only)

Query and command. The query SYST:MOD:ENAB? "<mnemonic>" returns "0" for disabled, "1" for enabled. The command SYST:MOD:ENAB "<mnemonic>" 0|1 will disable/enable the configuration.

Notes: Enabling a configuration that does not have a HW will result in run-time errors when trying to start that configuration. Trying to disable the default configuration will result in the error: -221, "Setting conflict:Cannot disable default process configuration '<mnemonic>'".

Example:

```
}
```

```
SCPI>>syst:mod:enab? "TRX1"
```

```
<<1
```

```
SCPI>>syst:mod:enab? "TRX2"
```

```
<<0
```

```
SCPI>>syst:err?
```

```
<<+0,"No error"
```

```
SCPI>>syst:mod:enab "TRX1",0
```

```
SCPI>>syst:err?
```

```
<<-221,"Settings conflict;Cannot disable default process configuration 'TRX1'"
```

Mode	All
Remote Command	:SYSTem:MODule:ENABle? "<mnemonic>" :SYSTem:MODule:ENABle "<mnemonic>",0 1
Example	

	:SYST:MOD:ENAB? "TRX1"
	:SYST:MOD:ENAB "TRX4",0

Preset	Not affected by Preset and Restore System Defaults Misc.
State Saved	No
Initial S/W Revision	A.13.80

Module Default (Remote Command Only)

Query and command. The query SYST:MOD:DEF? returns the mnemonic of the default configuration. The command SYST:MOD:DEF "mnemonic" will set that configuration as the default. If the configuration was disabled, the module default command on it will enable this configuration.

Example:

```
SCPI>>syst:mod:def?
<<"TRX1"
SCPI>>syst:mod:enab "TRX2",0
SCPI>>syst:mod:enab? "TRX2"
<<0
SCPI>>syst:mod:def "TRX2"
SCPI>>syst:mod:enab? "TRX2"
<<1
SCPI>>syst:mod:def?
<<"TRX2"
```

Mode	All
Remote Command	:SYSTem:MODule:DEFault? :SYSTem:MODule:DEFault "<mnemonic>"
Example	:SYST:MOD:DEF? :SYST:MOD:DEF "TRX1"

Preset	Not affected by Preset, reset to "Left" with Restore System Defaults Misc.
State Saved	No
Initial S/W Revision	A.13.80

Module Model Number (Remote Command Only)

Query only. The query ":SYST:MODule:MODEl?" will return model number of the current module.

Mode	All
Remote Command	:SYSTem:MODule:MODe1?
Example	:SYSTem:MODule:MODe1?
Notes	This query will return model number. e.g. "M9430A"
Preset	Not affected by Preset,
State Saved	No
Initial S/W Revision	E.14.14

Module Model Serial Number (Remote Command Only)

Query only. The query ":SYST: MODule:SERial?" will return model serial number of the current module.

Mode	All
Remote Command	:SYSTem:MODule:SERial?
Example	:SYSTem:MODule:SERial?
Notes	This query will return model serial number like "SN12344321"
Preset	Not affected by Preset
State Saved	No
Initial S/W Revision	E.14.14

Power On

Enables you to select how the instrument should power on. The options are: Mode and Input/Output Defaults, User Preset and Last State.

Key Path	System
Mode	All
Remote Command	:SYSTem: PON:TYPE MODE USER LAST :SYSTem: PON:TYPE?
Example	:SYST: PON:TYPE MODE
Preset	This is unaffected by a Preset but is set to Mode on a "Restore System Defaults->All"
State Saved	No
Backwards Compatibility SCPI	:SYSTem: PON:TYPE PRESet the "PRESet" parameter is supported for backward compatibility only and behaves the same as MODE.
Backwards Compatibility Notes	The Preset Type key in legacy analyzers has been removed, and the Power On toggle key has been replaced by this 1-of-N key in the System menu.
Initial S/W Revision	Prior to A.02.00

Mode and Input/Output Defaults

When the analyzer is powered on in Mode and Input/Output Defaults, it performs a Restore Mode Defaults to all modes in the instrument and also performs a Restore Input/Output Defaults.

Persistent parameters (such as Amplitude Correction tables or Limit tables) are not affected at power on, even though they are normally cleared by Restore Input/Output Defaults and/or Restore Mode Defaults.

Key Path	System, Power On
Mode	All
Example	SYST:PON:TYPE MODE
Readback Text	Defaults
Initial S/W Revision	Prior to A.02.00

User Preset

Sets **Power On** to **User Preset**. When the analyzer is powered on in User Preset, it will User Preset each mode and switch to the power-on mode. Power On User Preset will not affect any settings beyond what a normal User Preset affects.

NOTE

An instrument could never power up for the first time in User Preset.

Key Path	System, Power On
Mode	All
Example	SYST:PON:TYPE USER
Readback Text	User Preset
Backwards Compatibility Notes	Power On User Preset will cause the instrument to power up in the power-on mode, not the last mode the instrument was in prior to shut down. Also, Power On User Preset will User Preset all modes. This does not exactly match legacy behavior.
Initial S/W Revision	Prior to A.02.00

Last State

Sets **Power On** to **Last**. When the analyzer is powered on, it will put all modes in the last state they were in prior to when the analyzer was put into Power Standby and it will wake up in the mode it was last in prior to powering off the instrument. The saving of the active mode prior to shutdown happens behind the scenes when a controlled shutdown is requested by using the front panel power **Standby** key or by using the remote command `SYSTem:PDOWn`. The non-active modes are saved as they are deactivated and recalled by Power On Last State.

NOTE

An instrument can never power up for the first time in Last.

If line power to the analyzer is interrupted, for example by pulling the line cord plug or by switching off power to a test rack, Power On Last State may not work properly. For proper operation, Power On Last State depends on you shutting down the instrument using the Standby key or the SYSTem:PDOWn SCPI command. This will ensure the last state of each mode is saved and can be recalled during a power up.

Key Path	System, Power On
Mode	All
Example	SYST:PON:TYPE LAST
Notes	Power on Last State only works if you have done a controlled shutdown prior to powering on in Last. If a controlled shutdown is not done when in Power On Last State, the instrument will power up in the last active mode, but it may not power up in the active mode's last state. If an invalid mode state is detected, a Mode Preset will occur. To control the shutdown under remote control use the :SYSTem:PDOWn command.
Readback Text	Last State
Backwards Compatibility Notes	It is no longer possible to power-up the analyzer in the last mode the analyzer was running with that mode in the preset state. (ESA/PSA SYST:PRESET:TYPE MODE with SYST:PON:PRESET) You can power-on the analyzer in the last mode the instrument was running in its last state (SYST:PON:TYPE LAST), or you can specify the mode to power-up in its preset state (SYST:PON:MODE <mode>).
Initial S/W Revision	Prior to A.02.00

Power On Application

Accesses a menu that lists the available Modes and lets you select which Mode is to be the power-on application.

This application is used for Power On Type “Mode and Input/Output Defaults” and Restore System Defaults All.

Key Path	System, Power On
Mode	All
Remote Command	:SYSTem:PON:MODE SA BASIC ADEMOD NFIGURE PNOISE CDMA2K TDSCDMA VSA VSA89601 WCDMA WIMAXOFDMA :SYSTem:PON:MODE?
Example	SYST:PON:MODE SA
Notes	The list of possible modes (and remote parameters) to choose from is dependent on which modes are installed in the instrument.
Preset	This is unaffected by a Preset but is set on a “Restore System Defaults->All” to:
State Saved	No
Initial S/W Revision	Prior to A.02.00

Configure Applications

The Configure Applications utility can be used to:

- select applications for preload
- determine how many applications can fit in memory at one time
- specify the order of the Modes in the Mode menu.

This utility consists of a window with instructions, a set of “Select Application” checkboxes, a “fuel bar” style memory gauge, and keys that help you set up your configuration.

For more information, see the following topics:

["Preloading Applications" on page 182](#)

["Access to Configure Applications utility" on page 182](#)

["Virtual memory usage" on page 183](#)

Key Path	System, Power On
Example	:SYST:SHOW CAPP Displays the Config Applications screen
Initial S/W Revision	A.02.00

Preloading Applications

During runtime, if a Mode that is not preloaded is selected using the Mode menu or sending SCPI commands, there will be a pause while the Application is loaded. During this pause a message that says “Loading application, please wait ...” is displayed. Once loaded, the application stays loaded, so the next time you select it during a session, there is no delay.

Preloading enables you to “preload” at startup, to eliminate the runtime delay. Preloading an application will cause it to be loaded into the analyzer’s memory when the analyzer program starts up. If you do this, the delay will increase the time it takes to start up the analyzer program, but this may be preferable to having to wait the first time you select an application. Note that, once an application is loaded into memory, it cannot be unloaded without exiting and restarting the analyzer program.

Note that there are more applications available for the X-Series than can fit into Windows Virtual Memory. By allowing you to choose which licensed applications to load at startup, the Configure Applications utility allows you to make optimal use of your memory.

Access to Configure Applications utility

A version of the utility runs the first time you power up the analyzer after purchasing it from Keysight. The utility automatically configures preloads so that as many licensed applications as possible are preloaded while keeping the total estimated virtual memory usage below the limit. This auto-configuration only takes place at the very first run, and after analyzer software upgrades.

You may, at any time, manually call up the Configure Applications utility by pressing System, Power On, Configure Applications, to find a configuration that works best for you, and then restart the analyzer program.

The utility may also be called if, during operation of the analyzer, you attempt to load more applications than can fit in memory at once.

Virtual memory usage

There are more applications available for the X-Series than can fit into memory at any one time, so the Configure Applications utility includes a memory tracker that serves two purposes:

1. It will not let you preload more applications than will fit into memory at once.
2. You can determine how many of your favorite applications can reside in memory at one time.

The utility provides a graphical representation of the amount of memory (note that the memory in question here is Virtual memory and is a limitation imposed by the operating system, not by the amount of physical memory you have in your analyzer). You select applications to preload by checking the boxes on the left. Checked applications preload at startup. The colored fuel bar indicates the total memory required when all the checked applications are loaded (either preloaded or selected during runtime).

Here is what the fuel bar colors mean:

RED: the applications you have selected cannot all fit into the analyzer's memory. You must deselect applications until the fuel bar turns yellow.

YELLOW: the applications you have selected can all fit into the analyzer's memory, but there is less than 10% of the memory left, probably not enough to load any other applications, either via preload or by selecting a Mode while the analyzer is running..

GREEN: The indicator is green when <90% of the memory limit is consumed. This means the applications you have selected can all fit into the analyzer's memory with room to spare. You will likely be able to load one or more other applications without running out of memory.

Select All

Marks all applications in the selection list. This allows you to enable all applications licensed on the instrument for pre-loading, or is a convenience for selecting all applications in one operation and then letting you deselect individual applications.

Key Path	System, Power On, Configure Applications
Initial S/W Revision	A.02.00

Deselect All

Clears the marks from all applications in the selection list, except the Power On application. The Power On application cannot be eliminated from the pre-load list.

Key Path	System, Power On, Configure Applications
Initial S/W Revision	A.02.00

Move Up

The application list is the order that applications appear in the Mode Menu. This key enables you to shift the selected application up in the list, thus moving the selected application earlier in the Mode Menu.

Key Path	System, Power On, Configure Applications
Initial S/W Revision	A.02.00

Move Down

The application list is the order that applications appear in the Mode Menu. This key enables you to shift the selected application down in the list, thus moving the selected application later in the Mode Menu.

Key Path	System, Power On, Configure Applications
Initial S/W Revision	A.02.00

Select/Deselect

Toggles the currently highlighted application in the list.

Key Path	System, Power On, Configure Applications
Initial S/W Revision	A.02.00

Save Changes and Exit

Applies the configuration of the applications list. The marked applications will be pre-loaded in memory the next time the instrument application is started, and the order of the applications in the list will be the order of the applications in the Mode Menu.

After saving your changes, the analyzer asks you if you would like it to restart so that your changes can take effect (see dialog box, below). If you choose not to restart, the changes will not take effect until the next time you shut down and restart the analyzer.

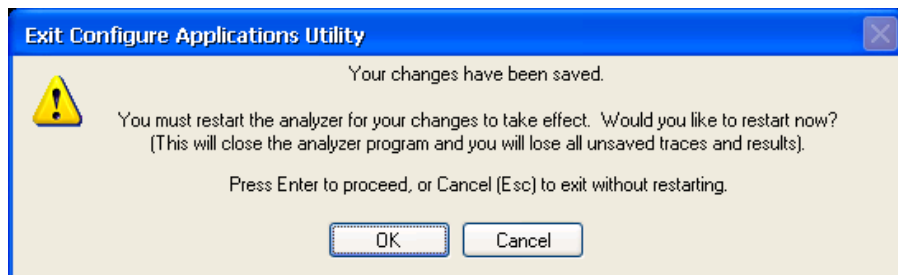

Key Path	System, Power On, Configure Applications
Remote Command	:SYSTem:PUP:PROcess
Example	:SYST:PUP:PROC This is the SCPI command for restarting the analyzer. You must Wait after this

	command for the instrument application to restart
Notes	The softkey will be grayed-out when the virtual memory of the selected applications exceeds 100% of the limit.
Notes	You cannot use *WAI or *OPC? to synchronize operation after a restart. This command stops and restarts the instrument application, thus the SCPI operation is terminated and restarted. A remote program must use fixed wait time to resume sending commands to the instrument. The wait time will be dependent upon which applications are pre-loaded.
Initial S/W Revision	A.02.00
Modified at S/W Revision	A.04.00

Exit Without Saving

Pressing this key will exit the Configure Applications utility without saving your changes.

Key Path	System, Power On, Configure Applications
Initial S/W Revision	A.02.00
Modified at S/W Revision	A.04.00

Restore Power On Defaults

This selection causes the Power On Type and Power On Application settings to be a reset to their default values. This level of Restore System Defaults does not affect any other system settings, mode settings and does not cause a mode switch. The Power On key, under the Restore System Defaults menu, causes the same action.

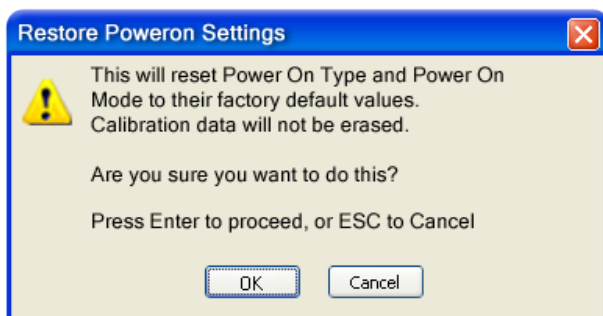

If you press any key other than OK or Enter, it is construed as a Cancel, because the only path that will actually cause the reset to be executed is through OK or Enter.

Key Path	System, Power On
Example	:SYST:DEF PON
Initial S/W Revision	Prior to A.02.00

Configure Applications - Instrument boot-up

At start-up of the analyzer program a dialog box similar to the one under the **System, Power On, Configure Applications** key will be displayed allowing you to choose which licensed applications are to be loaded. This dialog will only be displayed if the memory required to pre-load all of the licensed applications exceeds the Virtual Memory available.

Configure Applications - Windows desktop

The Configure Applications Utility may be run from the Windows Desktop. The utility is launched by double-



clicking the icon on the desktop, which brings-up a dialog box similar to the one under the **System, Power On, Configure Applications** key, allowing you to choose which licensed applications are to be loaded when the analyzer program starts up. This dialog box has mouse buttons on it that do the job the softkeys normally do in the **System, Power On, Configure Applications** menu.

Configure Applications - Remote Commands

The following topics provide details on using remote commands to configure the list of applications you want to load into the instrument memory or query the Virtual Memory utilization for your applications.

- "Configuration list (Remote Command Only)" on page 186
- "Configuration Memory Available (Remote Command Only)" on page 187
- "Configuration Memory Total (Remote Command Only)" on page 187
- "Configuration Memory Used (Remote Command Only)" on page 187
- "Configuration Application Memory (Remote Command Only)" on page 187

Configuration list (Remote Command Only)

This remote command is used to set or query the list of applications to be loaded in-memory.

Remote Command	:SYSTem:PON:APPLication:LLISt <string of INSTRument:SElect names> :SYSTem:PON:APPLication:LLISt?
Example	:SYST:PON:APPL:LLIS "SA,BASIC,WCDMA"
Notes	<string of INSTRument:SElect names> are from the enums of the :INSTRument:SElect command. The order of the <INSTRument:SElect names> is the order that the applications are loaded into memory, and the order that they appear in the Mode Menu. Error message -225 "Out of Memory" is reported when more applications are listed than can reside in Virtual Memory. When this occurs, the existing applications load list is unchanged.
Preset	Not affected by Preset
State Saved	Not saved in instrument state
Initial S/W Revision	A.02.00

Configuration Memory Available (Remote Command Only)

This remote command is used to query the amount of Virtual Memory remaining.

Remote Command	:SYSTem:PON:APPLication:VMEMory[:AVAILable]?
Example	:SYST:PON:APPL:VMEM?
Preset	Not affected by Preset
Initial S/W Revision	A.02.00

Configuration Memory Total (Remote Command Only)

This remote command is used to query the limit of Virtual Memory allowed for applications.

Remote Command	:SYSTem:PON:APPLication:VMEMory:TOTal?
Example	:SYST:PON:APPL:VMEM:TOT?
Preset	Not affected by Preset
Initial S/W Revision	A.02.00

Configuration Memory Used (Remote Command Only)

This remote command is a query of the amount of Virtual Memory used by all measurement applications.

Remote Command	:SYSTem:PON:APPLication:VMEMory:USED?
Example	:SYST:PON:APPL:VMEM:USED?
Preset	Not affected by Preset
Initial S/W Revision	A.02.00

Configuration Application Memory (Remote Command Only)

This remote command is used to query the amount of Virtual Memory a particular application consumes.

Remote Command	:SYSTem:PON:APPLication:VMEMory:USED:NAME? <INSTRument:SElect name>
Example	:SYST:PON:APPL:VMEM:USED:NAME? CDMA2K
Notes	<INSTRument:SElect name> is from the enums of the :INSTRument:SElect command Value returned will be 0 (zero) if the name provided is invalid.
Preset	Not affected by Preset
Initial S/W Revision	Prior to A.02.00

Alignments

The Alignments Menu controls and displays the automatic alignment of the instrument, and provides the ability to restore the default alignment values.

The current setting of the alignment system is displayed in the system Settings Panel along the top of the display, including a warning icon for conditions that may cause specifications to be impacted.



Key Path	System
Initial S/W Revision	Prior to A.02.00

Align Now

Accesses alignment processes that are immediate action operations. They perform complete operations and run until they are complete.

Key Path	System, Alignments
Initial S/W Revision	Prior to A.02.00

All (Daily use)

Immediately executes an alignment of all subsystems which includes both the source and the analyzer in the TRX module. The “All” alignment is sufficient to maintain specified performance, provided that (1) the TRX’s internal temperature has not drifted more than +/-5 degree C since the previous alignment, and (2) no more than 8 hours have elapsed since the previous “All” alignment., and (3) no more than 1 week has elapsed since these three alignments have all been run: IF, RF, and Source, and (4) a 45 minute warm-up period between power-up of the TRX and invoking the “All” alignment. The instrument stops any measurement currently underway, performs the alignment, then restarts the measurement from the beginning (similar to pressing the **Restart** key).

If an interfering user signal is present at the RF Input, the alignment is performed on all subsystems except the RF. After completion, the Error Condition message “Align skipped: 50 MHz interference” or “Align skipped: 4.8 GHz interference” is generated. In addition the Error Condition message “Align Now, RF required” is generated, and bits 11 and 12 are set in the Status Questionable Calibration register.

The query form of the remote commands (:CALibration[:ALL]? or *CAL?) invokes the alignment of all subsystems and returns a success or failure value. An interfering user signal is not grounds for failure; if the alignment was able to succeed on all portions but unable to align the RF because of an interfering signal, the resultant will be the success value.

Successful completion of **Align Now, All** will clear the “Align Now, All required” Error Condition, and clear bit 14 in the Status Questionable Calibration register. It will also begin the elapsed time counter for Last Align Now, All Time, and capture the Last Align Now, All Temperature.

If the Align RF subsystem succeeded in aligning (no interfering signal present), the elapsed time counter begins for Last Align Now, RF Time, and the temperature is captured for the Last Align Now, RF Temperature. In addition the Error Conditions “Align skipped: 50 MHz interference” and “Align skipped: 4.8 GHz interference” are cleared, the Error Condition “Align Now, RF required” is cleared, and bits 11 and 12 are cleared in the Status Questionable Calibration register

Align Now, All can be interrupted by pressing the Cancel (ESC) front-panel key or remotely with Device Clear followed by the :ABORT SCPI command. When this occurs the Error Condition message “Align Now, All required” is generated, and bit 14 is set in the Status Questionable Condition register. This is because new alignment data may be employed for an individual subsystem, but not a cohesive set of data for all subsystems.

In many cases, you might find it more convenient to change alignments to Normal, instead of executing Align Now, All. When the Auto Align process transitions to Normal, the analyzer will immediately start to update only the alignments that have expired, thus efficiently restoring the alignment process.

NOTE

In EXF, Source ARB play will be turned off and the source states will not be restored after **Align Now, All**.

Key Path	System, Alignments, Align Now
Mode	All
Remote Command	:CALibration[:ALL] :CALibration[:ALL]?
Example	:CAL
Notes	:CALibration[:ALL]? returns 0 if successful :CALibration[:ALL]? returns 1 if failed :CALibration[:ALL]? is the same as *CAL? While Align Now, All is performing the alignment, bit 0 in the Status Operation register is set. Completion, or termination, will clear bit 0 in the Status Operation register. This command is sequential; it must complete before further SCPI commands are processed. Interrupting the alignment from remote is accomplished by invoking Device Clear followed by the :ABORT command. Successful completion will clear bit 14 in the Status Questionable Calibration register. An interfering user signal is not grounds for failure of Align Now, All. However, bits 11 and 12 are set in the Status Questionable Calibration register to indicate Align Now, RF is required. An interfering user supplied signal will result in the instrument requiring an Align Now, RF with the interfering signal removed.
Couplings	Initializes the time for the Last Align Now, All Time. Records the temperature for the Last Align Now, All Temperature. If Align RF component succeeded, initializes the time for the Last Align Now, RF Time. If Align RF component succeeded, records the temperature for the Last Align Now, RF Temperature.
Status Bits/OPC dependencies	Bits 11, 12, or 14 may be set in the Status Questionable Calibration register.
Initial S/W Revision	Prior to A.02.00

Mode	All
Remote Command	*CAL?
Example	*CAL?
Notes	<p>*CAL? returns 0 if successful</p> <p>*CAL? returns 1 if failed</p> <p>:CALibration[:ALL]? is the same as *CAL?</p> <p>See additional remarks described with :CALibration[:ALL]?</p> <p>Everything about :CALibration[:ALL]? is synonymous with *CAL? including all conditions, status register bits, and couplings</p>
Initial S/W Revision	Prior to A.02.00

Mode	All
Remote Command	:CALibration[:ALL]:NPENding
Example	CAL:NPEN
Notes	<p>:CALibration[:ALL]:NPENding is the same as :CALibration[:ALL] including all conditions, status register bits, except this scpi command does not BLOCK the scpi session, so the user should use status register bits to query if the calibration is successfully completed or not.</p> <p>Typical usage is:</p> <ol style="list-style-type: none"> 1) :CALibration:ALL:NPENding (Start a calibration) 2) :STATus:OPERation:CONDition? (Check if the calibration is completed or not, If bit 0 is set, then the system is doing calibration, the user should repeat this scpi query until the bit is cleared) 3):STATus:QUEStionable:CALibration:CONDition? (Check if there are any errors/failures in previous calibration procedure
Initial S/W Revision	X.14.20

All but RF

Immediately executes an alignment of all subsystems except the RF subsystem which includes both the source and the analyzer in the TRX module . The instrument will stop any measurement currently underway, perform the alignment, and then restart the measurement from the beginning (similar to pressing the Restart key). This can be used to align portions of the instrument that are not impacted by an interfering user input signal.

This operation might be chosen instead of **All** if you do not want the device under test to experience a large change in input impedance, such as a temporary open circuit at the analyzer input.

The query form of the remote commands (:CALibration:NRF?) will invoke the alignment and return a success or failure value.

Successful completion of Align Now, All but RF will clear the “Align Now, All required” Error Condition, and clear bit 14 in the Status Questionable Calibration register. If “Align Now, All required” was in effect prior to executing the All but RF, the Error Condition message “Align Now, RF required” is generated and bit 12 in

the Status Questionable Calibration register is set. It will also begin the elapsed time counter for Last Align Now, All Time, and capture the Last Align Now, All Temperature.

Align Now, All but RF can be interrupted by pressing the Cancel (ESC) front-panel key or remotely with Device Clear followed by the :ABORt SCPI command. When this occurs the Error Condition message “Align Now, All required” is generated, and bit 14 is set in the Status Questionable Condition register. This is because new alignment data may be used for an individual subsystem, but not a full new set of data for all subsystems.

NOTE

In EXF, Source ARB play will be turned off and the source states will not be restored after **Align Now, All but RF**.

Key Path	System, Alignments, Align Now
Mode	All
Remote Command	:CALibration:NRF :CALibration:NRF?
Example	:CAL:NRF
Notes	:CALibration:NRF? returns 0 if successful :CALibration:NRF? returns 1 if failed While Align Now, All but RF is performing the alignment, bit 0 in the Status Operation register is set. Completion, or termination, will clear bit 0 in the Status Operation register. This command is sequential; it must complete before further SCPI commands are processed. Interrupting the alignment from remote is accomplished by invoking Device Clear followed by the :ABORt command. Successful completion will clear bit 14 in the Status Questionable Calibration register and set bit 12 if invoked with “Align Now, All required”.
Couplings	Initializes the time for the Last Align Now, All Time. Records the temperature for the Last Align Now, All Temperature.
Status Bits/OPC dependencies	Bits 12 or 14 may be set in the Status Questionable Calibration register.
Initial S/W Revision	Prior to A.02.00

Mode	All
Remote Command	:CALibration:NRF:NPENding
Example	CAL:NRF:NPEN
Notes	:CALibration:NRF:NPENding is the same as :CALibration:NRF including all conditions, status register bits, except that this scpi command does not BLOCK the scpi session, so the user should use status register bits to query if the calibration is successfully completed or not. Typical usage is: 1):CALibration:NRF:NPENding (start theAll but RF calibration) 2):STATus:OPERation:CONDition? (If bit 0 is set, then the system is doing calibration, the user should do re-query until this bit is cleared)

	3):STATus:QUEStionable:CALibration:CONDition? (to check if there are any errors/failures in previous calibration procedure)
Initial S/W Revision	X.14.20

RF (Weekly use)

Immediately executes an alignment of the RF subsystem which includes both the source and the analyzer in the TRX module . The instrument stops any measurement currently underway, performs the alignment, then restarts the measurement from the beginning (similar to pressing the **Restart** key).

This alignment corrects slow-rate drift which does not impair specifications for time periods shorter than one week. Thus, it is required to perform this alignment on a weekly basis to maintain specifications. This alignment typically takes >2 minutes to complete.

This operation might be desirable if the alignments had been set to not include RF alignments, or if previous RF alignments could not complete because of interference which has since been removed.

If an interfering user signal is present at the RF Input, the alignment will terminate and generate the Error Condition message “Align skipped: 50 MHz interference” or “Align skipped: 4.8 GHz interference”, and Error Condition “Align Now, RF required”. In addition, bits 11 and 12 will be set in the Status Questionable Calibration register.

The query form of the remote commands (:CALibration:RF?) will invoke the alignment of the RF subsystem and return a success or failure value. An interfering user signal is grounds for failure.

Successful completion of Align Now, RF will begin the elapsed time counter for Last Align Now, RF Time, and capture the Last Align Now, RF Temperature.

Align Now, RF can be interrupted by pressing the Cancel (ESC) front-panel key or remotely with Device Clear followed by the :ABORt SCPI command. When this occurs, the Error Condition message “Align Now, RF required” is generated, and bit 12 is set in the Status Questionable Condition register. None of the new alignment data is used.

NOTE

In EXF, Source ARB play will be turned off and the source states will not be restored after **Align Now, All but RF**.

Key Path	System, Alignments, Align Now
Mode	All
Remote Command	:CALibration:RF :CALibration:RF?
Example	:CAL:RF
Notes	:CALibration:RF? returns 0 if successful :CALibration:RF? returns 1 if failed (including interfering user signal) While Align Now, RF is performing the alignment, bit 0 in the Status Operation register is set. Completion, or termination, will clear bit 0 in the Status Operation register. This command is sequential; it must complete before further SCPI commands are processed. Interrupting the alignment from remote is accomplished by invoking Device Clear followed by the

	<p>:ABORt command.</p> <p>Successful completion clears the Error Conditions “Align skipped: 50 MHz interference” and “Align skipped: 4800 MHz interference” and the Error Conditions “Align RF failed” and “Align Now, RF required”, and clears bits 3, 11, and 12 in the Status Questionable Calibration register.</p> <p>A failure encountered during alignment will generate the Error Condition message “Align RF failed” and set bit 3 in the Status Questionable Calibration register.</p> <p>An interfering user signal will result in bits 11 and 12 to be set in the Status Questionable Calibration register to indicate Align Now, RF is required.</p> <p>An interfering user supplied signal will result in the instrument requiring an Align Now, RF with the interfering signal removed.</p>
Couplings	<p>Initializes the time for the Last Align Now, RF Time.</p> <p>Records the temperature for the Last Align Now, RF Temperature.</p>
Status Bits/OPC dependencies	Bits 11, 12, or 14 may be set in the Status Questionable Calibration register.
Initial S/W Revision	Prior to A.02.00
Mode	All
Remote Command	:CALibration:RF:NPENding
Example	CAL:RF:NPEN
Notes	<p>:CALibration:RF:NPENding is the same as :CALibration:RF including all conditions, status register bits, except that this scpi command does not BLOCK the scpi session, so the user should use status register bits to query if the calibration is successfully completed or not.</p> <p>Typical usage is:</p> <ol style="list-style-type: none"> 1):CALibration:RF:NPENding (Start a RF calibration) 2):STATus:OPERation:CONDition? (If bit 0 is set, then the system is doing calibration, the user should do re-query until this bit is cleared) 3):STATus:QUESTionable:CALibration:CONDition? (to check if there are any errors/failures in previous calibration procedure)
Initial S/W Revision	X.14.20

Source (Weekly use)

Accesses source alignment processes that are immediate action operations. They perform complete operations and run until they are complete.

Immediately executes an IQ alignment, and power level alignment. The instrument stops any sequence of the source, performs the alignment, then restarts the sequence from the beginning.

This alignment corrects slow-rate drift which does not impair specifications for time periods shorter than one week. Thus, it is required to perform this alignment on a weekly basis to maintain specifications. This alignment typically takes >2 minutes to complete.

There is no alert available for the source alignment. The operators have the responsibility to check temperature shift since last Align Now, Source to determine if the source alignment needs to be executed.

Key Path	System, Alignments, Align Now
Mode	All
Remote Command	:CALibration:INTernal:SOURce[:ALL] :CALibration:INTernal:SOURce[:ALL]?
Example	:CAL:INT:SOUR
Notes	:CAL:SOUR? Initiates an Alignment and returns 0 if successful :CAL:SOUR? Initiates an Alignment and returns 1 if failed
Couplings	Initializes the time for the Last Align Source Now, All Time. Records the temperature for the Last Align Source Now, All Temperature.
Initial S/W Revision	A.05.00

Mode	All
Remote Command	:CALibration:INTernal:SOURce[:ALL]:NPENding
Example	CAL:INT:SOUR:NPEN
Notes	:CALibration:INTernal:SOURce[:ALL]:NPENding is the same as :CALibration:INTernal:SOURce[:ALL] including all conditions, status register bits, except that this scpi command does not BLOCK the scpi session, so the user should use status register bits to query if the calibration is successfully completed or not. Typical usage is: 1):CALibration:INTernal:SOURce:NPENding (start an internal source calibration) 2):STATus:OPERation:CONDition? (Check if the calibration is completed or not, If bit 0 is set, then the system is doing calibration, the user should repeat this scpi query until the bit is cleared) 3):STATus:QUEStionable:CALibration:EXTended:FAILure:CONDition? (Check if bit 14 is set or not. If this bit is set, that means there are some errors in previous internal source calibration)
Initial S/W Revision	X.14.20

IF Alignment (Weekly use)

Immediately executes an alignment of the IF subsystem which includes both the source and the analyzer in the TRX module. The instrument stops any measurement currently underway, perform the alignment, and then restart the measurement from the beginning (similar to pressing the Restart key). This alignment corrects slow-rate which the drift does not impair specifications for time periods shorter than one week. Thus, it is required to perform this alignment on a weekly basis to maintain specifications. This alignment typically takes >4 minutes to complete.

A failure of IF will set the Error Condition “Align IF failed” and set bit 4 in the Status Questionable Calibration register. A failure will not employ new IF alignment data.

Successful completion of IF will clear the Error Condition “Align IF failed” and clear bit 6 in the Status Questionable Calibration register.

Align IF can be interrupted by pressing the Cancel (ESC) front-panel key or from remote with Device Clear followed by the :ABORt SCPI command. When this occurs, no new IF alignment data will be employed.

The query form of the remote commands (:CALibration:IF?) will invoke the alignment of the IF subsystem and return a success or failure value.

Note: In EXF, Source ARB play will be turned off and the source states will not be restored after IF Alignment.

Key Path	System, Alignments, Align Now
Mode	All
Remote Command	:CALibration:IF :CALibration:IF?
Example	:CAL:IF
Notes	:CALibration:IF? returns 0 if successful :CALibration:IF? returns 1 if failed While Align Now, IF is performing the alignment, bit 0 in the Status Operation register is set. Completion, or termination, will clear bit 0 in the Status Operation register. This command is sequential; it must complete before further SCPI commands are processed. Interrupting the alignment from remote is accomplished by invoking Device Clear followed by the :ABORt command. Successful completion will clear bit 14 in the Status Questionable Calibration register.
Preset	Not affected by Preset and Restore System Defaults Misc.
State Saved	No
Initial S/W Revision	E.14.00

Mode	All
Remote Command	:CALibration:IF:NPENding
Example	CAL:IF:NPEN
Notes	:CALibration:IF:NPENding is the same as :CALibration:IF including all conditions, status register bits, except that this scpi command does not BLOCK the scpi session, so the user should use status register bits to query if the calibration is successfully completed or not. Typical usage is: 1) :CALibration:IF:NPENding (Start a IF calibration) 2) :STATus:OPERation:CONDition? (Check if the calibration is completed or not, If bit 0 is set, then the system is doing calibration, the user should repeat this scpi query until the bit is cleared) 3) :STATus:QUEStionable:CALibration:CONDition? (Check if bit 4 is set or not. If this bit is set, that means there are some errors in previous internal source calibration)
Initial S/W Revision	X.14.20

Show Alignment Statistics

Shows alignment information you can use to ensure that the instrument is operating in a specific manner. The Show Alignment Statistics screen is where you can view time and temperature information.

Values which are displayed are only updated when the Show Alignment Statistics screen is invoked, they are not updated while the Show Alignment Statistics screen is being displayed. The remote commands that access this information obtain current values.

An example of the Show Alignment Statistics screen would be similar to:

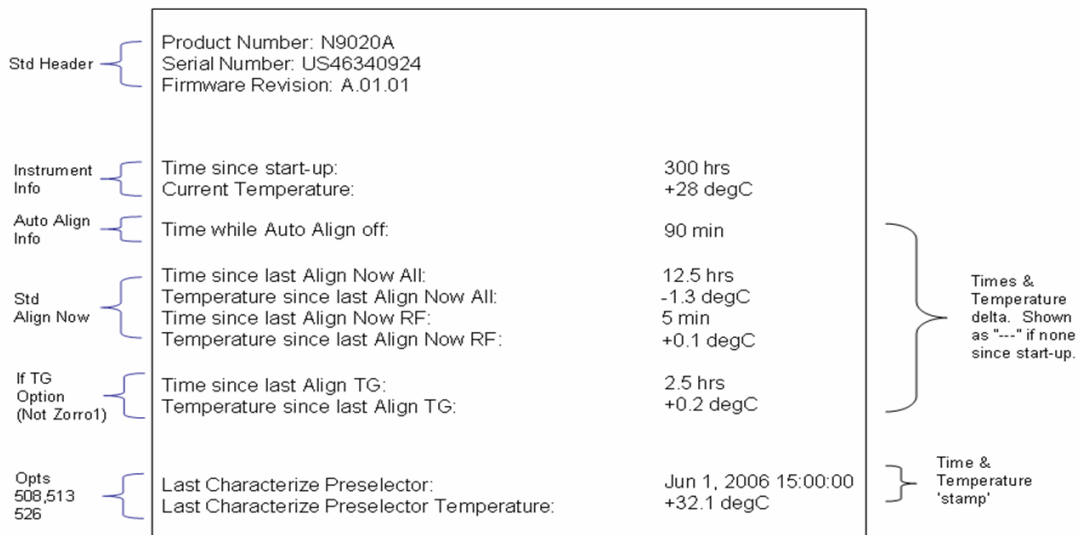

A successful Align Now, RF will set the Last Align RF temperature to the current temperature, and reset the Last Align RF time. A successful Align Now, All or Align Now, All but RF will set the Last Align Now All temperature to the current temperature, and reset the Last Align Now All time. A successful Align Now, All will also reset the Last Align RF items if the RF portion of the Align Now succeeded.

Key Path	System, Alignments
Mode	All
Notes	The values displayed on the screen are only updated upon entry to the screen and not updated while the screen is being displayed.
Initial S/W Revision	Prior to A.02.00

Key Path	Visual annotation in the Show Alignment Statistics screen
Mode	All
Remote Command	:SYSTem:PON:TIME?
Example	:SYST:PON:TIME?
Notes	Value is the time since the most recent start-up in seconds.

State Saved	No
Initial S/W Revision	Prior to A.02.00

Key Path	Visual annotation in the Show Alignment Statistics screen
Mode	All
Remote Command	:CALibration:TEMPerature:CURRent?
Example	:CAL:TEMP:CURR?
Notes	Value is in degrees Centigrade. Value is invalid if using default alignment data (Align Now, All required)
State Saved	No
Initial S/W Revision	Prior to A.02.00

Key Path	Visual annotation in the Show Alignment Statistics screen
Mode	All
Remote Command	:CALibration:TIME:LALL?
Example	:CAL:TIME:LALL?
Notes	Value is the elapsed time, in seconds, since the last successful Align Now, All or Align Now, All but RF was executed.
State Saved	No
Initial S/W Revision	Prior to A.02.00

Key Path	Visual annotation in the Show Alignment Statistics screen
Mode	All
Remote Command	:CALibration:TEMPerature:LALL?
Example	:CAL:TEMP:LALL?
Notes	Value is in degrees Centigrade at which the last successful Align Now, All or Align Now, All but RF was executed.
State Saved	No
Initial S/W Revision	Prior to A.02.00

Key Path	Visual annotation in the Show Alignment Statistics screen
Mode	All
Remote Command	:CALibration:TIME:LRF?
Example	:CAL:TIME:LRF?

Notes	Value is the elapsed time, in seconds, since the last successful Align Now, RF was executed, either individually or as a component of Align Now, All.
State Saved	No
Initial S/W Revision	Prior to A.02.00

Key Path	Visual annotation in the Show Alignment Statistics screen
Mode	All
Remote Command	:CALibration:TEMPerature:LRF?
Example	:CAL:TEMP:LRF?
Notes	Value is in degrees Centigrade at which the last successful Align Now, RF was executed, either individually or as a component of Align Now, All.
State Saved	No
Initial S/W Revision	Prior to A.02.00

Key Path	SCPI Only
Mode	All
Remote Command	:CALibration:TIME:LIF?
Example	:CAL:TIME:LIF?
Notes	Value is the elapsed time, in seconds, since the last successful Align IF was executed.
State Saved	No
Initial S/W Revision	A.14.50

Key Path	SCPI Only
Mode	All
Remote Command	:CALibration:TEMPerature:LIF?
Example	:CAL:TEMP:LIF?
Notes	Value is in degrees Centigrade at which the last successful Align IF was executed.
State Saved	No
Initial S/W Revision	A.14.50

Restore Align Defaults

Initializes the alignment user interface settings, not alignment data, to the factory default values. Align Now, All must be executed if the value of the Timebase DAC results in a change.

For front panel operation, you are prompted to confirm action before setting the alignment parameters to factory defaults:

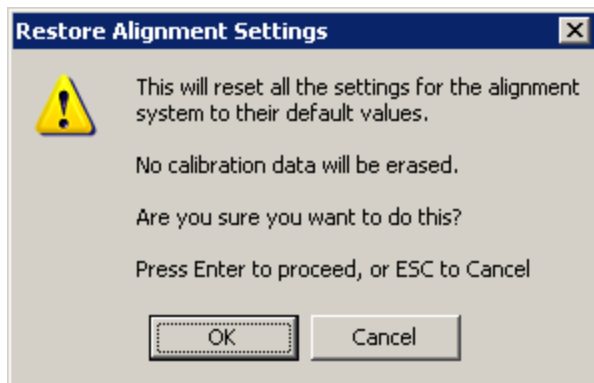

The parameters affected are:

Parameter	Setting
Timebase DAC	Calibrated
Timebase DAC setting	Calibrated value
Auto Align State	Normal (if the instrument is not operating with default alignment data, Off otherwise)
Auto Align All but RF	Off
Auto Align Alert	Time & Temperature

Key Path	System, Alignments
Mode	All
Example	:SYST:DEF ALIG
Notes	Alignment processing that results as the transition to Auto Alignment Normal will be executed sequentially; thus *OPC? or *WAI will wait until the alignment processing is complete.
Initial S/W Revision	Prior to A.02.00

Execute Expired Alignments (Remote Command Only)

Alignments can be expired in the situation where Auto Align is in the state of Partial or Off. This feature runs the alignments that have expired. This is different than performing an Align All, Now operation. Align All, Now performs an alignment of all subsystems regardless of whether they are needed or not, with Execute Expired Alignments, only the individual subsystems that have become due are aligned.

Mode	All
Remote Command	:CALibration:EXPIred?
Example	:CAL:EXP?
Notes	:CALibration:EXPIred? returns 0 if successful

	:CALibration:EXPIred? returns 1 if failed
Initial S/W Revision	Prior to A.02.00

I/O Config

Activates a menu for identifying and changing the I/O configuration for remote control.

Key Path	System
Initial S/W Revision	Prior to A.02.00

SCPI LAN

Activates a menu for identifying and changing the SCPI over a LAN configuration. There are a number of different ways to send SCPI remote commands to the instrument over LAN. It can be a problem to have multiple users simultaneously accessing the instrument over the LAN. These keys limit that somewhat by disabling the telnet, socket, and/or SICL capability.

Key Path	System, I/O Config
Initial S/W Revision	Prior to A.02.00

SCPI Telnet

Turns the SCPI LAN telnet capability On or Off allowing you to limit SCPI access over LAN through telnet.

Key Path	System, I/O Config, SCPI LAN
Mode	All
Remote Command	:SYSTem:COMMunicate:LAN:SCPI:TELNet:ENABle OFF ON 0 1 :SYSTem:COMMunicate:LAN:SCPI:TELNet:ENABle?
Example	:SYST:COMM:LAN:SCPI:TELN:ENAB OFF
Preset	This is unaffected by Preset but is set to ON with a "Restore System Defaults->Misc"
State Saved	No
Range	On Off
Initial S/W Revision	Prior to A.02.00

SCPI Socket

Turns the capability of establishing Socket LAN sessions On or Off. This allows you to limit SCPI access over LAN through socket sessions.

Key Path	System, I/O Config, SCPI LAN
Mode	All
Remote Command	:SYSTem:COMMunicate:LAN:SCPI:SOCKet:ENABle OFF ON 0 1 :SYSTem:COMMunicate:LAN:SCPI:SOCKet:ENABle?
Example	:SYST:COMM:LAN:SCPI:SOCK:ENAB OFF
Preset	This is unaffected by a Preset but is set to ON with a “Restore System Defaults->Misc”
State Saved	No
Range	On Off
Initial S/W Revision	Prior to A.02.00

SICL Server

Turns the SICL server capability On or Off, enabling you to limit SCPI access over LAN through the SICL server. (SICL IEEE 488.2 protocol.)

Parameter	Description	Setting
Maximum Connections	The maximum number of connections that can be accessed simultaneously	5
Instrument Name	The name (same as the remote SICL address) of your analyzer	inst0
Instrument Logical Unit	The unique integer assigned to your analyzer when using SICL LAN	8
Emulated GPIB Name	The name (same as the remote SICL address) of the device used when communicating with your analyzer	gpib7
Emulated GPIB Logical Unit	The unique integer assigned to your device when it is being controlled using SICL LAN	8
Emulated GPIB Address	The emulated GPIB address assigned to your transmitter tester when it is a SICL server (the same as your GPIB address)	18

Key Path	System, I/O Config, SCPI LAN
Mode	All
Remote Command	:SYSTem:COMMunicate:LAN:SCPI:SICL:ENABle OFF ON 0 1 :SYSTem:COMMunicate:LAN:SCPI:SICL:ENABle?
Example	:SYST:COMM:LAN:SCPI:SICL:ENAB OFF
Preset	This is unaffected by Preset, but is set to ON with a “Restore System Defaults->Misc”
State Saved	No
Range	On Off
Initial S/W Revision	Prior to A.02.00

HiSLIP Server

Turns the HiSLIP server capability On or Off, enabling you to limit SCPI access over LAN through the HiSLIP server.

HiSLIP stands for High Speed LAN Instrument Protocol and is part of the IVI-6.1 specification.

Here is an example of a VISA connection string used to connect to the HiSLIP Server on an X-Series Spectrum Analyzer:

```
TCPIP0::a-n9030a-93016::hislip0::INSTR
```

In the example above, hislip0 is the HiSLIP device name that VISA users must include in their HiSLIP VISA Address strings. Your HiSLIP device name may be different depending on your VISA settings.

Key Path	System, I/O Config, SCPI LAN
Mode	All
Remote Command	:SYSTem:COMMunicate:LAN:SCPI:HISLip:ENABle OFF ON 0 1 :SYSTem:COMMunicate:LAN:SCPI:HISLip:ENABle?
Example	:SYST:COMM:LAN:SCPI:HISL:ENAB OFF
Preset	This is unaffected by Preset, but is set to ON with a “Restore System Defaults->Misc”
State Saved	No
Range	On Off
Initial S/W Revision	A.11.00

SCPI Socket Control Port (Remote Command Only)

Returns the TCP/IP port number of the control socket associated with the SCPI socket session. This query enables you to obtain the unique port number to open when a device clear is to be sent to the instrument. Every time a connection is made to the SCPI socket, the instrument creates a peer control socket. The port number for this socket is random. The user must use this command to obtain the port number of the control socket. To force a device clear on this socket, open the port and send the string “DCL” to the instrument.

If this SCPI command is sent to a non SCPI Socket interface, then 0 is returned.

Mode	All
Remote Command	:SYSTem:COMMunicate:LAN:SCPI:SOCKet:CONTrol?
Example	:SYST:COMM:LAN:SCPI:SOCK:CONT?
Preset	This is unaffected by Preset or “Restore System Defaults->Misc”.
State Saved	No
Range	0 to 65534
Min	0
Max	65534
Initial S/W Revision	Prior to A.02.00

System IDN Response

This key allows you to specify a response to the *IDN? query, or to return the analyzer to the Factory response if you have changed it.

To choose the factory-set response, press the **Factory** key.

To specify your own response, press the **User** key, and enter your desired response.

If your test software is expecting the response to indicate Agilent Technologies as the Manufacturer, you can conveniently configure the response by pressing the Agilent key.

Key Path	System, I/O Config
Mode	All
Remote Command	
Notes	<ul style="list-style-type: none"> • This affects the response given in all Modes of the Analyzer, unless the current Mode has also specified a custom response, in which case the current Mode's custom IDN response takes precedence over the System's, but only while that Mode is the current Mode.. • It survives shutdown and restart of the software and therefore survives a power cycle
Preset	This is unaffected by Preset but is set to Factory on a "Restore System Defaults-> Misc"
State Saved	No
Initial S/W Revision	A.06.00
Modified at S/W Revision	x.14.50

Factory

This key selects the factory setting, for example:

"Keysight Technologies,E6650A,MY00012345,E.14.50"

where the fields are manufacturer, model number, serial number, firmware revision.

Key Path	System, I/O Config, IDN Response
Example	:SYST:IDN:CONF FACT
Initial S/W Revision	A.06.0

User

This key allows you to specify your own response to the *IDN? query. You may enter your desired response with the Alpha Editor or a plugin PC keyboard.

When you press this key, the active function becomes the current User string with the cursor at the end. This makes it easy to edit the existing string.

If you enter a null string (for example, by clearing the User String while editing and then pressing **Done**) the analyzer automatically reverts to the Factory setting.

Key Path	System, I/O Config, IDN Response
Example	:SYST:IDN:CONF USER
Initial S/W Revision	A.06.00

Restore Defaults

Provides incremental initialization of the system setting groups along with supporting a comprehensive reset of the entire instrument back to a factory default state. The menu selections are the groups of system settings and when one is selected, that particular group of system settings is reset back to their default values.

Key Path	System
Mode	All
Remote Command	:SYSTem:DEFault [ALL] ALIGn INPut MISC MODes PON
Example	SYST:DEF
State Saved	No
Initial S/W Revision	Prior to A.02.00

Restore Input/Output Defaults

Causes the group of settings and data associated with Input/Output front-panel key to be a reset to their default values. This level of Restore System Defaults does not affect any other system settings, mode settings and does not cause a mode switch. .

Confirmation is required to restore the Input/Output setting. The confirmation dialog is:

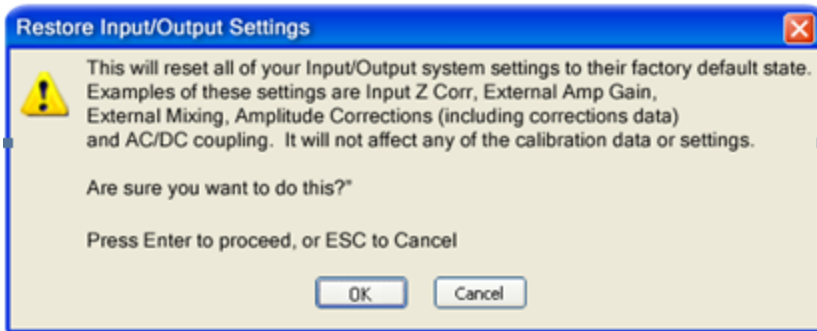

Key Path	System, Restore System Defaults
Example	:SYST:DEF INP
Initial S/W Revision	Prior to A.02.00

Restore Power On Defaults

This selection causes the Power On settings to be a reset to their default value. This level of Restore System Defaults does not affect any other system settings, mode settings and does not cause a mode switch. The Power On settings and their default values are Power On Type reset to Mode and Input/Output Defaults and Power On Application reset to whatever the factory set as its default value.

Confirmation is required to restore the factory default values. The confirmation dialog is:

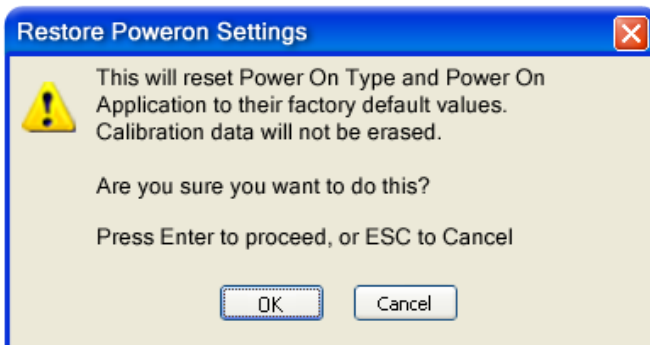

Key Path	System, Restore System Defaults
Example	:SYST:DEF PON
Initial S/W Revision	Prior to A.02.00

Restore Align Defaults

This selection causes the Alignment system settings to be a reset to their default values. This does not affect any Alignment data stored in the system. This level of Restore System Defaults does not affect any other system settings, mode settings and does not cause a mode switch.

After performing this function, it may impact the auto-alignment time of the instrument until a new alignment baseline has been established.

Confirmation is required to restore the factory default values. The confirmation dialog is:

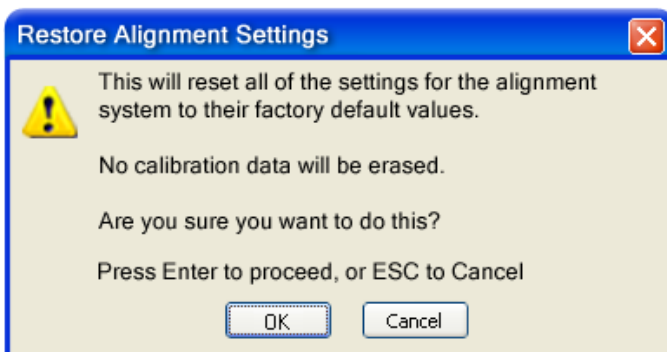

Key Path	System, Restore System Defaults
Example	:SYST:DEF ALIG
Initial S/W Revision	Prior to A.02.00

Restore Misc Defaults

This selection causes miscellaneous system settings to be reset to their default values. With this reset, you lose the GPIB address and it is reset to 18, so this should be used with caution. This level of Restore System Defaults does not affect any other system settings, mode settings and does not cause a mode switch. This miscellaneous group contains the rest of the settings that have not been part of the other Restore System Defaults groups. The following table is a complete list of settings associated with this group:

Miscellaneous Setting	Default Value
Verbose SCPI	Off
The SYST:PRES:TYPE	MODE
Auto File Name Number	000
Save Type	State
State Save To	Register 1
Screen Save To	SCREEN000.png
DISP:ENABLE	ON
Full Screen	Off
SCPI Telnet	ON
SCPI Socket	ON
SICL Server	ON
Softkey Language	English
System Annotation	ON
Display Theme	TDCOLOR
System IDN Response	Factory result of *IDN?
System IDN Response selection	Factory

Confirmation is required to restore the factory default values. The confirmation dialog is:

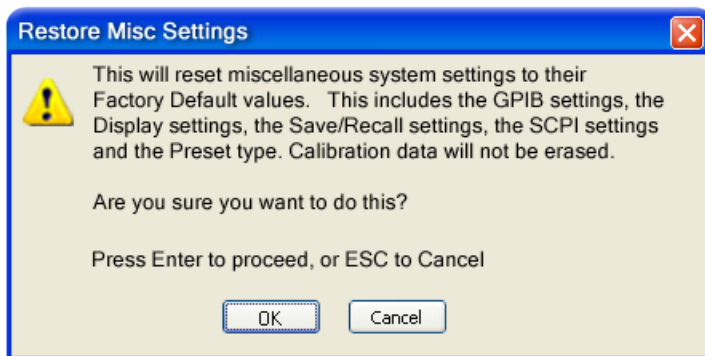

Key Path	System, Restore System Defaults
Example	:SYST:DEF MISC
Initial S/W Revision	Prior to A.02.00
Modified at S/W Revision	x.14.50

Restore Mode Defaults (All Modes)

This selection resets all of the modes in the instrument back to their default state just as a Restore Mode Defaults does and it switches the instrument to the power-on mode and causes the default measurement for the power-on mode to be active. This level of Restore System Defaults does not affect any system settings, but it does affect the state of all modes and does cause a mode switch unless the instrument was already in the power-on mode.

Confirmation is required to restore the factory default values. The confirmation dialog is:

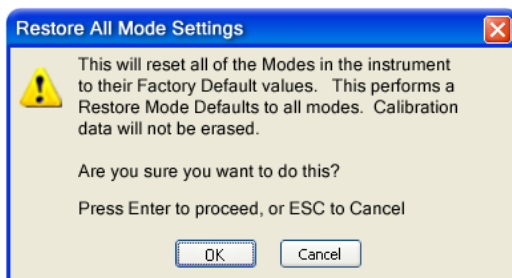

Key Path	System, Restore System Defaults
Example	:SYST:DEF MOD
Couplings	An All Mode will cause the currently running measurement to be aborted, mode switch to the power-on mode and activate the default measurement for the power-on mode.. It gets the mode to a consistent state with all of the default couplings set.
Initial S/W Revision	Prior to A.02.00

All

This performs a comprehensive reset of ALL analyzer settings to their factory default values. It resets all of the system setting groups, causes a Restore Mode Defaults for all modes in the instrument, and switches back to the power-on mode. It does not affect the User Preset file or any user saved files.

Confirmation is required to restore the factory default values. The confirmation dialog is:

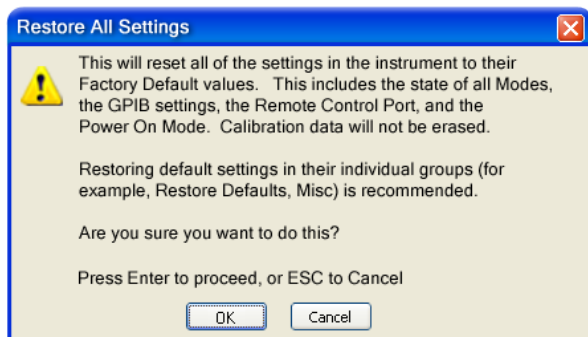

NOTE

If you are using an Keysight USB External Mixer, then you will need to perform a Refresh USB Mixer Connection after Restoring All Defaults.

Key Path	System, Restore System Defaults
Example	:SYST:DEF ALL
Notes	If using Keysight USB External Mixer, perform a Refresh USB Mixer Connection (SCPI command :MIX:BAND USB) following a Restore All Defaults.
Couplings	An All will cause the currently running measurement to be aborted and get all modes to a consistent state, so it is unnecessary to couple any settings.
Initial S/W Revision	Prior to A.02.00
Modified at S/W Revision	A.14.00

Control Panel...

Opens the Windows Control Panel. The Control Panel is used to configure certain elements of Windows that are not configured through the hardkey/softkey System menus.

NOTE

This feature is not available if option SF1 is installed.

The Control Panel is a separate Windows application, so to return to the analyzer once you are in the Control Panel, you may either:

Exit the Control Panel by clicking on the red X in the upper right hand corner, with a mouse

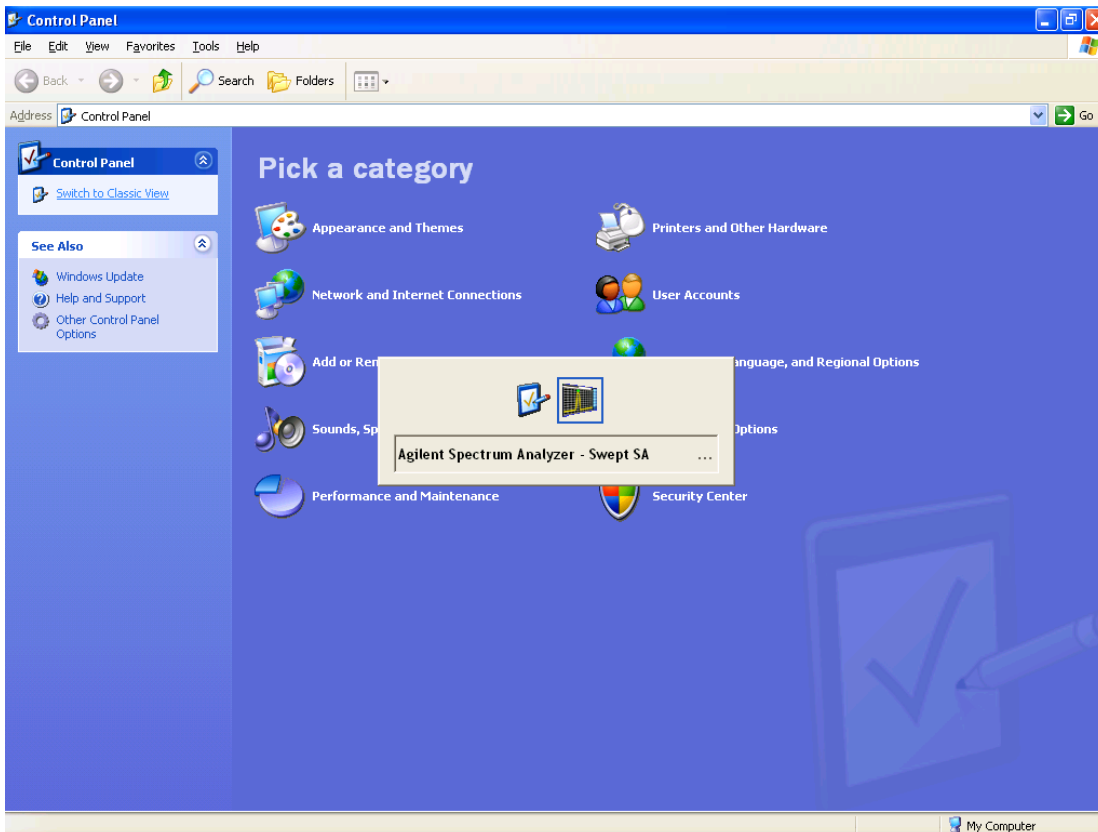

Or use Alt-Tab: press and hold the Alt  key and press and release the Tab key until the Analyzer logo is showing in the window in the center of the screen, as above, then release the Alt key.

Key Path	System
Notes	No remote command for this key.
Initial S/W Revision	Prior to A.02.00

Licensing...

Opens the license explorer.

NOTE This feature is not available if option SF1 is installed.

For Help on this key, select Help in the menu bar at the top of the license explorer window.

Key Path	System
Notes	No equivalent remote command for this key.
Backwards Compatibility Notes	In ESA the SCPI command for displaying the Show Licenses screen is: :SYSTem:CONFIgure:LKEY:STATe OFF ON 0 1:SYSTem:CONFIgure:LKEY:STATe?

	There are no equivalent SCPI commands in the X-Series for displaying the License Explorer.
Initial S/W Revision	Prior to A.02.00

Remote Command	:SYSTem:LKEY <"OptionInfo">, <"LicenseInfo">
Example	SYST:LKEY "N9073A-1FP", "027253AD27F83CDA5673A9BA5F427FDA5E4F25AEB1017638211AC9F60D9C639FE539735909C551DE0A91"
Notes	The <"OptionInfo"> contains the feature and the version. You must specify the feature but can omit the version. If you omit the version, the system regards it as the latest one, since the system knows which version is supported for each feature. The <"LicenseInfo"> contains the signature, the expiration date, and serial number for transport if transportable. You must specify the signature, but you can omit the other information. If you omit the expiration date, the system regards it as permanent. If you omit the serial number, the system regards it as non-transportable. As a result, this supports reverse compatibility.
Initial S/W Revision	Prior to A.02.00

Remote Command	:SYSTem:LKEY:DELeTe <"OptionInfo">,<"LicenseInfo">
Example	SYST:LKEY:DEL 'N9073A-1FP', "027253AD27F83CDA5673A9BA5F427FDA5E4F25AEB1017638211AC9F60D9C639FE539735909C551DE0A91"
Notes	The <"OptionInfo"> contains the feature and the version. You must specify the feature but can omit the version. If you omit the version, the system regards it as the latest one, if more than one version is installed. The <"LicenseInfo"> contains the signature, the expiration date, and whether or not be transportable. You must specify the signature, but you can omit the other information. If you omit the expiration date, the system regards it as permanent. If you omit the transportability, the system regards it as non-transportable. As a result, this supports reverse compatibility.
Initial S/W Revision	Prior to A.02.00

Remote Command	:SYSTem:LKEY:LIST?
Notes	Return Value: An <arbitrary block data> of all the installed instrument licenses. The format of each license is as follows. <Feature>,<Version>,<Signature>,<Expiration Date>,<Serial Number for Transport>

Return Value Example:

#3136

N9073A-1FP,1.000,B043920A51CA

N9060A-2FP,1.000,4D1D1164BE64

N9020A-508,1.000,389BC042F920

N9073A-1F1,1.000,5D71E9BA814C,13-aug-2005

<arbitrary block data> is:

#NMMM<data>

Where:

N is the number of digits that describes the number of MMM characters. For example if the data was 55 bytes, N would be 2.

MMM would be the ASCII representation of the number of bytes. In the previous example, N would be 55.

<data> ASCII contents of the data

Initial S/W Revision	Prior to A.02.00
----------------------	------------------

Remote Command	:SYSTem:LKEY? <"OptionInfo">
-----------------------	------------------------------

Example	SYST:LKEY? "N9073A-1FP"
----------------	-------------------------

Notes	The <"OptionInfo"> contains the feature and the version. You must specify the feature but can omit the version. If you omit the version, the system regards it as the latest one.
-------	---

Return Value:

<"LicenseInfo"> if the license is valid, null otherwise.

<"LicenseInfo"> contains the signature, the expiration date, and serial number if transportable.

Return Value Example:

"B043920A51CA"

Initial S/W Revision	Prior to A.02.00
----------------------	------------------

Remote Command	:SYSTem:HID?
-----------------------	--------------

Notes	Return value is the host ID as a string
-------	---

Initial S/W Revision	Prior to A.02.00
----------------------	------------------

Security

Accesses capabilities for operating the instrument in a security controlled environment.

Key Path	System
----------	---------------

Initial S/W Revision	A.04.00
----------------------	---------

USB

The Windows operating system can be configured to disable write access to the USB ports for users who are in a secure environment where transferring data from the instrument is prohibited. This user interface is a convenient way for the customer to disable write access to USB.

Key Path	System, Security
Mode	All
Scope	Mode Global
Remote Command	:SYSTem:SECurity:USB:WPRotect[:ENABLE] ON OFF 0 1 :SYSTem:SECurity:USB:WPRotect[:ENABLE]?
Example	:SYST:SEC:USB:WPR ON Will set USB ports to Read-only
Notes	When the USB ports are in Read-only mode then no data can be stored to USB, including the internal USB memory used for a back-up location for the calibration data.
Dependencies	This key is grayed-out unless the current user has administrator privileges.
Preset	This is unaffected by Preset or any Restore System Defaults. An Agilent Recovery will set the USB to write protect OFF
State Saved	No
Range	Read-Write Read only
Initial S/W Revision	A.04.00

Read-Write

Selection for allowing full read-write access to the USB ports.

Key Path	System, Security, USB
Example	:SYST:SEC:USB:WPR OFF Will set USB ports to Read-Write
Initial S/W Revision	A.04.00

Read only

Selection for disabling write access to the USB ports.

Key Path	System, Security, USB
Example	:SYST:SEC:USB:WPR ON Will set USB ports to Read only
Initial S/W Revision	A.04.00

Diagnostics

The Diagnostics key in the System menu gives you access to basic diagnostic capabilities of the instrument.

Key Path	System
Initial S/W Revision	Prior to A.02.00

Show Hardware Statistics

Provides a display of various hardware statistics. The statistics include the following:

- High and Low temperature extremes
- Elapsed time that the instrument has been powered-on (odometer)

The display should appear listing the statistics, product number, serial number, and firmware revision.

Hardware Statistical Information	
Agilent MXA Signal Analyzer	
Product Number: N9020A	
Serial Number: US00061145	
Instrument S/W Revision: A.12.00	
Revision Date: 7/11/2012 12:11:10 PM	
Component Name	Value
MechAtten #1 Count Total	457304
Calibrator Switch Cycles	105953
AC/DC Switch Cycles	114240
2 dB #1 Mechanical Atten Cycles	112655
2 dB #2 Mechanical Atten Cycles	124456
MechAtten #2 Count Total	472265
6 dB Mechanical Atten Cycles	115302
10 dB Mechanical Atten Cycles	93602
20 dB Mechanical Atten Cycles	144781
30 dB Mechanical Atten Cycles	118580
Low Noise Path Switch	45668
Preselector Bypass Cycles	31133
High temperature operating extreme	45.75
Low temperature operating extreme	-23.9375
Elapsed Time (On-Time)(hours)	134164

In some CXA models this field is called "Fixed Atten"

Some CXA models omit these fields

Only shown if LNP installed

Only shown if MPB installed

The CXA models in which the AC/DC Switch field is called Fixed Atten and that omit the mechanical attenuation fields are the N9000A–503/507 models.

Modular HWs only have time and temperature information in Show Hardware Statistics.

The data will be updated only when the Show Hardware Statistics menu key is pressed, it will not be updated while the screen is displayed.

The tabular data should be directly printable.

Key Path	System, Diagnostics
Mode	All
Notes	The values displayed on the screen are only updated upon entry to the screen and not updated while the screen is being displayed.
Initial S/W Revision	Prior to A.02.00

SCPI for Show Hardware Statistics (Remote Commands Only)

Each of the hardware statistic items can be queried via SCPI.

- Error! Reference source not found.
- Error! Reference source not found.
- Error! Reference source not found.

Advanced

Accesses advanced diagnostic capabilities performed in the factory or under instructions from repair procedures. This menu key is only visible when the logged-in user is "saservice".

NOTE This feature is not available if option SF1 is installed.

The first access to the Advanced Diagnostic Menu after invoking the instrument application will require an authentication, which is to enter the Service Code. Subsequent accesses to the Advanced Diagnostic Menu are unimpeded. The Authentication dialog looks like:

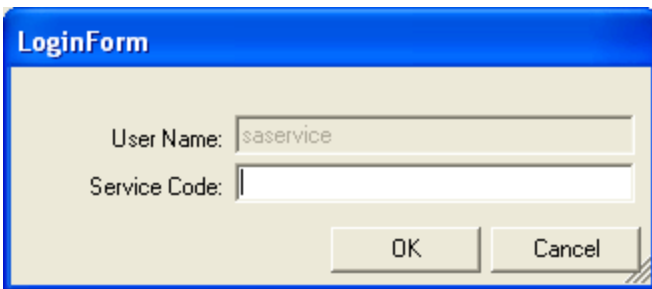

"OK" is the default key thus the Enter key is used to complete the entry. If invalid Service Code is entered authentication is not granted and you are provided the following dialog:

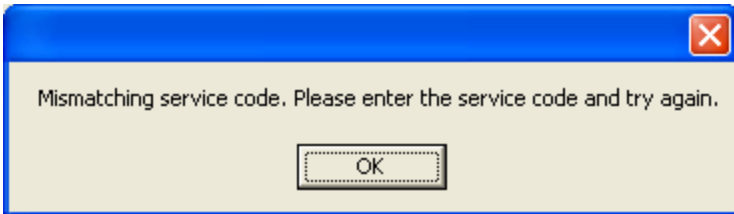

Key Path	System, Diagnostics
Notes	Password is required to access this menu.
Initial S/W Revision	Prior to A.02.00

Key Recorder

Access the Key Recorder feature. The full details to the Key Recorder are in the [Key Recorder How-to document](#).

Key Path	System, Diagnostics, Advanced
Initial S/W Revision	Prior to A.02.00

Key Recorder On/Off

See the [Key Recorder How-to document](#), listed here is the table information for LP/SEP use:

Key Path	System, Diagnostics, Advanced, Key Recorder
Mode	All
Notes	The startup of the key recorder is controlled by a registry entry, refer to the key recorder document listed above.
Preset	Not affected by Preset.
State Saved	No
Range	On Off
Initial S/W Revision	Prior to A.02.00

Show Keystroke History...

Launches Notepad with the key recorder history file loaded. See the [Key Recorder How-to document](#), listed here is the table information for LP/SEP use:

Key Path	System, Diagnostics, Advanced, Key Recorder
Notes	Operator is responsible for exiting Notepad and returning focus to the Instrument Application.
Initial S/W Revision	Prior to A.02.00

Self test

This key gives you access to diagnostic capabilities for self tests of the instrument.

Key Path	System, Diagnostics
Initial S/W Revision	Prior to A.10.00

All Self Test

This key invokes all the self tests defined in the Diagnostics Self Test section.

Key Path	System, Diagnostics, Self Test
Remote Command	SYSTem:TEST:WCTS:[ALL]
Example	SYST:TEST:WCTS:[ALL]
Initial S/W Revision	A.12.50

FEC Self Test

This key invokes the EXT E6607C front end control self test. When operation is complete, the generated test summary information is appended to log file E:\Agilent\Instrument\FECTestLog.txt. This test summary file can be retrieved from the instrument using the MMEM set of SCPI command, once you have the fully qualified the path and file name.

If the self test fails, the following error message will be generated:

“-330, Self-test failed, see log file E:\Agilent\Instrument\FECTestLog.txt”

If the self test passes, an advisory message “FEC self-test completed successfully” is generated.

Key Path	System, Diagnostics, Self Test
Remote Command	SYSTem:TEST:WCTS:FEC
Example	SYST:TEST:WCTS:FEC
Notes	Access log with command : MMEM:DATA? "E:\ Agilent\Instrument\FECTestLog.txt"
Initial S/W Revision	A.12.50

Show Result

This key gives you access to show results of the following self tests:

- Source self-test results
- E6607C embedded MPA or E6640A/E6650A RFIO self-test results
- E6607C FEC self-test results

Key Path	System, Diagnostics, Self Test
Initial S/W Revision	A.12.50

FEC Self Test Results

Provides a display of last FEC test results, the display should appear listing model number, serial number and test time at the top of display, and then list test date/time, test name, measured value, valid range and pass/fail of each FEC test item, the tabular data should be directly printable.

Key Path	System, Diagnostics, Self Test, Show Results
Remote Command	SYSTem:TEST:WCTS:SHOW:RESult FEC
Example	SYST:TEST:WCTS:SHOW:RES FEC
Initial S/W Revision	A.12.50

The example of FEC self test result display is as follows:

FEC Self Test Results					
Produce Number: E6607C					
Serial Number: MY51380437					
Instrument S/W: 11/16/2012 2:51:19 PM					
FpgaVersionTest					
Date	Time(GMT)	Name	MeasValue	ValidRange	Result
11/23/2012	16:13:56	Analog_FPGA	16.000	>= 16.000	Pass
11/23/2012	16:13:56	Digital_FPGA	50.000	>= 46.000	Pass
11/23/2012	16:13:56	CRFS_FPGA	38.000	>= 38.000	Pass
PowerSupplyTest					
Date	Time(GMT)	Name	MeasValue	ValidRange	Result
11/23/2012	16:13:56	ABUS_+32CHK	31.904	30.900 - 32.900	Pass
11/23/2012	16:13:56	ABUS_+12CHK	12.296	10.800 - 13.200	Pass
11/23/2012	16:13:56	+10VA	9.935	9.600 - 10.200	Pass
11/23/2012	16:13:56	+5VA	4.995	4.900 - 5.100	Pass
11/23/2012	16:13:56	+3.3VA	3.299	3.200 - 3.400	Pass
11/23/2012	16:13:56	-3.3VA	-3.311	-3.400 - - 3.200	Pass
11/23/2012	16:13:56	ACOM	0.00	-0.200 - 0.200	Pass
11/23/2012	16:13:56	-5VA	-5.036	-5.100 - - 4.900	Pass
11/23/2012	16:13:56	-6.1VA	-5.880	-6.200 - - 5.700	Pass

11/23/2012	16:13:56	-10VA	-10.116	-10.200 -- 9.800	Pass
11/23/2012	16:13:56	ABUS_-2.5V_REF	-2.508	-2.520 -- 2.470	Pass
11/23/2012	16:13:56	ABUS_+2.5V_REF	2.508	2.480 - 2.520	Pass
11/23/2012	16:13:56	ABUS_-10VPALC	-10.047	-10.200 -- 9.800	Pass
11/23/2012	16:13:57	ABUS_DET_MOD_FLT	18.000	7.800 - 100.000	Pass

Show FEC Self Test Results contents (Remote Command Only)

A remote command is available to obtain the contents of the Show FEC Self Test Results screen (the entire contents, not just the currently displayed page).

Remote Command	SYSTem:TEST:WCTS:FEC:RESult?
Example	SYST:TEST:WCTS:FEC:RES?
Notes	The output is an IEEE Block format of the Show FEC Self Test Results contents. Each line is separated with a new-line character.
Initial S/W Revision	A.12.50

	Keysight Converged	PSA
IP Address	SYSTem:COMMunicate:LAN:ADDRes <string> SYSTem:COMMunicate:LAN:ADDRes?	:SYSTem:COMMunicate:LAN[SELF]:IP <string> :SYSTem:COMMunicate:LAN[SELF]:IP?
Gateway	SYSTem:COMMunicate:LAN:DGATeway <string> SYSTem:COMMunicate:LAN:DGATeway?	:SYSTem:COMMunicate:LAN[SELF]:GATEway <string> :SYSTem:COMMunicate:LAN[SELF]:GATEway?
Subnet Mask	SYSTem:COMMunicate:LAN:SMASk <string> SYSTem:COMMunicate:LAN:SMASk?	:SYSTem:COMMunicate:LAN[SELF]:SUBNetmask <string> :SYSTem:COMMunicate:LAN[SELF]:SUBNetmask?

Internet Explorer...

This key launches Microsoft Internet Explorer. A mouse and external keyboard are highly desired for using Internet Explorer. When Internet Explorer is running, close Internet Explorer to return focus to the Instrument Application (or use Alt-Tab).

Key Path	System
Mode	All
Notes	No equivalent remote command for this key.
Initial S/W Revision	A.05.01

(Undefined variable: Primary.ProductName)
IQ Analyzer Mode Reference

7 Trigger Functions

Trigger

Accesses a menu of keys to control the selection of the trigger source and the setup of each of the trigger sources. The analyzer is designed to allow triggering from a number of different sources, for example, Free Run, Video, External, RF Burst, and so forth.

The TRIG:SOURCe command (below) will specify the trigger source for the currently selected input (RF or I/Q). If you change inputs, the new input remembers the trigger source it was last programmed to for the current measurement, and uses that trigger source. You can directly set the trigger source for each input using the TRIGger:RF:SOURce and TRIGger:IQ:SOURce commands (later in this section). When in External Mixing, the analyzer uses the RF trigger source.

Note the inclusion of the <measurement> parameter in the command below. Because each measurement remembers its own Trigger Source, the command must be qualified with the measurement name. Note that for the Swept SA measurement this is not the case; for backwards compatibility, no <measurement> parameter is used when setting the Trigger Source for the Swept SA measurement.

See ["Trigger Source Presets" on page 221](#)

See ["RF Trigger Source" on page 224](#)

See ["I/Q Trigger Source" on page 225](#)

See ["More Information" on page 226](#)

Key Path	Front-panel key
Remote Command	<pre>:TRIGger:<measurement>[:SEquence]:SOURce EXTernal1 EXTernal2 IMMediate LINE FRAMe RFBurst VIDeo IF ALARm LAN IQMag IDEMod QDEMod IINPut QINPut AIQMag TV :TRIGger:<measurement>[:SEquence]:SOURce?</pre> <p>where <measurement> is the measurement for which you wish to set the Source (blank for the Swept SA measurement)</p>
Example	<pre>TRIG:ACP:SOUR EXT1</pre> <p>Selects the external 1 trigger input for the ACP measurement and the selected input</p> <pre>TRIG:SOUR VID</pre> <p>Selects video triggering for the Swept SA (SANalyzer) measurement in the Spectrum Analyzer mode. For SAN, do not use the <measurement> keyword. Only send this form in the Spectrum Analyzer mode or you will get an Undefined Header error</p>
Notes	<p>Not all measurements have all the trigger sources available to them. Check the trigger source documentation for your specific measurement to see what sources are available.</p> <p>Not all trigger sources are available for each input. See the "RF Trigger Source" on page 224 and "I/Q Trigger Source" on page 225 commands for detailed information on which trigger sources are available for each input.</p> <p>Other trigger-related commands are found in the INITiate and ABORt SCPI command subsystems.</p> <p>*OPC should be used after requesting data. This will hold off any subsequent changes to the selected trigger source, until after the sweep is completed and the data is returned.</p> <p>Available ranges and presets can vary from mode to mode.</p>
Dependencies	<p>In some models, there is no second External input. In these models, the External 2 key is blanked and</p>

	the EXternal2 parameter will generate a "Hardware missing; Not available for this model number" message.
Preset	See table below
Status Bits/OPC dependencies	The Status Operation Register bit 5 "Waiting for Trigger" is set at the same time as the Sweeping or Measuring bit is set. It is cleared when the trigger actually occurs (that is, after the trigger event occurs and all the applicable trigger criteria have been met). A corresponding pop-up message ("Waiting for trigger") is generated if no trigger signal appears after approximately 2 sec. This message goes away when a trigger signal appears.
Backwards Compatibility SCPI	:TRIGger[:SEquence]:SOURce EXternal For backward compatibility, the parameter EXternal is mapped to EXternal1
Backwards Compatibility SCPI	[:SENSe]:<measurement>:TRIGger:SOURce This backwards compatibility alias command is provided for ESA/PSA compatibility This backwards compatibility command does not apply to the Swept SA measurement, for that just use :TRIGger:SOURce This backwards compatibility command does not apply to the monitor spectrum, log plot and spot frequency measurements
Backwards Compatibility SCPI	[:SENSe]:<measurement>:TRIGger:SOURce IF In earlier instruments, the parameter IF was used by apps for the video trigger, so using the IF parameter selects VIDeo triggering. Sending IF in the command causes VID to be returned to a query.
Backwards Compatibility SCPI	[:SENSe]:ACPr:TRIGger:SOURce This backwards Compatibility SCPI command is provided to support the same functionality as [:SENSe]:ACPr:TRIGger:SOURce (PSA W-CDMA, PSA cdma2000 and PSA 1xEVDO) due to the fact that the ACPr node conflicts with the ACPower node.
Initial S/W Revision	Prior to A.02.00
Modified at S/W Revision	A.03.00

Trigger Source Presets

Here are the Trigger Source Presets for the various measurements:

Meas	Mode	Preset for RF	Preset for IQ	Notes
Swept SA	SA	IMM	IQ not supported	
CHP	SA, WCDMA, C2K, WIMAX OFDMA, 1xEVDO, DVB-T/H, DTMB, LTE, LTETDD, CMMB, ISDB-T, Digital Cable TV, MSR	IMM	IQ not supported	
OBW	SA, WCDMA, C2K, WIMAX OFDMA,	1xEVDO: EXT1 others: IMM	IQ not supported	For 1xEVDO mode, the trigger source is coupled with the gate state, as well as the gate

	TD-SCDMA, 1xEVDO, LTE, LTETDD, CMMB, ISDB-T, MSR			source. When the trigger source changes to RFBurst, External1 or External2, the gate state is set to on, and the gate source is set identically with the trigger source. When the trigger source changes to IMMEDIATE, VIDEO, LINE, FRAME or IF, the gate state is set to off.
CCDF	SA, WCDMA, C2K, WIMAX OFDMA, TD-SCDMA, 1xEV-DO, DVB-T/H, DTMB, LTE, LTETDD, CMMB, ISDB-T, Digital Cable TV, MSR	WIMAX OFDMA: RFBurst LTETDD: BTS: External 1 MS: Periodic Timer TD-SCDMA and 1xEV-DO: BTS: External 1 MS: RFBurst SA, WCDMA, C2K, LTE, CMMB, ISDB-T, DVB-T/H, DTMB, Digital Cable TV, MSR: IMMEDIATE	TD-SCDMA and 1xEV-DO: BTS: External 1 MS: IQMag LTETDD: BTS: External 1 MS: Periodic Timer Others: IMM	For TD-SCDMA: Trigger source is coupled with radio device. When radio device changes to BTS, trigger source will be changed to EXTERNAL1. When radio device changes to MS, trigger source will be set as RFBurst for RF or IQ Mag for BBIQ. When TriggerSource is RFBurst or IQ Mag, Measure Interval is grayed out.
ACP	SA, WCDMA, C2K, WIMAX OFDMA, TD-SCDMA, 1xEVDO, DVB-T/H, DTMB, LTE, LTETDD, CMMB, ISDB-T, Digital Cable TV, MSR	IMM	IQ not supported	
Tx Power	SA, GSM, TD-SCDMA	SA, GSM: RFBurst TD-SCDMA: EXTERNAL	IMM	TD-SCDMA doesn't support the Line and Periodic Timer parameters. When the mode is TD-SCDMA, if the Radio Device is switched to BTS, the value will be changed to External 1 and if the Radio device is switched to MS, the value will be changed to RFBurst
SPUR	SA, WCDMA, C2K, WIMAX OFDMA, TD-SCDMA, 1xEV-DO, DVB-T/H, LTE, LTETDD, MSR	IMM	IQ not supported	
SEM	SA, WCDMA, C2K, WIMAX OFDMA, TD-SCDMA, 1xEVDO, DVB-	1xEVDO(BTS): EXTERNAL1 All others: IMMEDIATE	IQ not supported	

	T/H, DTMB, LTE, LTETDD, CMMB, ISDB-T, Digital Cable TV, MSR			
CDP	WCDMA	IMM	IMM	
RHO	WCDMA	IMM	IMM	
PCON	WCDMA	IMM	IMM	
QPSK	WCDMA, C2K, 1xEVDO	All except CDMA1xEVDO: IMMediate CDMA1xEVDO: EXT1	IMM	
MON	All except SA and BASIC	IMM	IQ not supported	
WAV		LTETDD: BTS: External 1 MS: Periodic Timer GSM/EDGE: RFBurst All others: IMMediate	LTETDD: BTS: External 1 MS: Periodic Timer GSM/EDGE: IQMag All others: IMMMediate	
PVT	WIMAXOFDMA	RFB	IMM	
EVM	WIMAXOFDMA, DVB-T/H, DTMB, LTE, LTETDD, CMMB, ISDB-T, Digital Cable TV	All but CMMB: IMM CMMB: Periodic Timer	All but CMMB: IMM CMMB: External 1	LTE, LTETDD supports Free Run, Video and External 1 only.
SPEC	BASIC	IMM	IMM	
LOG Plot	PN	IMM	IQ not supported	
Spot Freq	PN	IMM	IQ not supported	
GMSK PVT	EDGE/GSM	RFB	IMM	
GMSK PFER	EDGE/GSM	RFB	IQMag	
GMSK ORFS	EDGE/GSM	RF Burst	IQ not supported	
EDGE PVT	EDGE/GSM	RFB	IMM	

EDGE EVM	EDGE/GSM	RFB	IQMag
EDGE ORFS	EDGE/GSM	Periodic Timer	IQ not supported
Combined WCDMA	WCDMA	IMM	IQ not supported
Combined GSM	EDGE/GSM	RFB	IQ not supported
List Power Step	WCDMA, EDGE/GSM	IMM	IQ not supported
Transmit On/Off Power	LTETDD	LTETDD: BTS: External 1 MS: Periodic Timer	LTETDD: BTS: External 1 MS: Periodic Timer
Transmit Analysis	BLUETOOTH	RFB	IQ not supported
Adjacent Channel Power	BLUETOOTH	IMM	IQ not supported
LE In-band Emissions	BLUETOOTH	IMM	IQ not supported
EDR In-band Spurious Emissions	BLUETOOTH	Periodic Timer	IQ not supported
Conformance EVM	LTE, LTETDD, MSR	IMM	IMM

RF Trigger Source

The **RF Trigger Source** command selects the trigger to be used for the specified measurement when RF is the selected input. The RF trigger source can be queried and changed even while another input is selected, but it is inactive until RF becomes the selected input.

Note the inclusion of the <measurement> parameter in the command below. Because each measurement remembers its own Trigger Source, the command must be qualified with the measurement name. Note that for the Swept SA measurement this is not the case; for backwards compatibility, no <measurement> parameter is used when setting the Trigger Source for the Swept SA measurement.

Remote Command	<code>:TRIGger:<measurement>[:SEquence]:RF:SOURce EXTernal1 EXTernal2 IMMEDIATE LINE FRAME RFBurst VIDEO IF ALARm LAN TV</code> <code>:TRIGger:<measurement>[:SEquence]:RF:SOURce?</code>
-----------------------	--

Example	<code>TRIG:ACP:RF:SOUR EXT1</code> Selects the external 1 trigger input for the ACP measurement and the RF input
----------------	---

	<p>TRIG:RF:SOUR VID</p> <p>Selects video triggering for the SANalyzer measurement and the RF input. For SAN, do not use the <measurement> keyword.</p>
Notes	<p>Not all measurements have all the trigger sources available to them. Check the trigger source documentation for your specific measurement to see what sources are available.</p> <p>Not all trigger sources are available for each input. For the RF Trigger Source, the following trigger sources are available:</p> <ul style="list-style-type: none"> –IMMediate - free run triggering –VIDeo - triggers on the video signal level –LINE - triggers on the power line signal –EXTernal1 (or EXTernal) - triggers on an externally connected trigger source marked “Trigger 1 In” on the rear panel –EXTernal2 - triggers on an externally connected trigger source marked “Trigger 2 In” on the front panel. In some models, there is no second External input. In these models, the External 2 key is blanked and the EXTernal2 parameter will generate a “Hardware missing; Not available for this model number” message –RFBurst - triggers on the bursted frame –FRAMe - triggers on the periodic timer –IF (video) - same as video, for backwards compatibility only <p>*OPC should be used after requesting data. This will hold off any subsequent changes to the selected trigger source, until after the sweep is completed and the data is returned.</p> <p>Available ranges, and presets can vary from mode to mode.</p>
Status Bits/OPC dependencies	<p>The Status Operation Register bit 5 "Waiting for Trigger" is set at the same time as the Sweeping or Measuring bit is set. It is cleared when the trigger actually occurs (that is, after the trigger event occurs and all the applicable trigger criteria have been met). A corresponding pop-up message ("Waiting for trigger") is generated if no trigger signal appears after approximately 2 sec. This message goes away when a trigger signal appears.</p>
Initial S/W Revision	Prior to A.02.00

I/Q Trigger Source

This command selects the trigger to be used for the specified measurement when I/Q (which requires option BBA) is the selected input. The I/Q trigger source can be queried and changed even while another input is selected, but it is inactive until I/Q becomes the selected input.

Remote Command	<pre>:TRIGger:<measurement>[:SEquence]:IQ:SOURce EXTernal1 EXTernal2 IMMediate IQMag IDEMod QDEMod IINPut QINPut AIQMag :TRIGger:<measurement>[:SEquence]:IQ:SOURce?</pre>
Example	<p>TRIG:WAVeform:SOUR IQM</p> <p>Selects I/Q magnitude triggering for the IQ Waveform measurement and the I/Q input</p>
Notes	<p>Not all measurements have all the trigger sources available to them. Check the trigger source documentation for your specific measurement to see what sources are available.</p> <p>Not all trigger sources are available for each input. For the I/Q Trigger Source, the following trigger sources are available:</p>

	<ul style="list-style-type: none"> –IMMediate - free run triggering –EXternal1 (or EXternal) - triggers on an externally connected trigger source on the rear panel –EXternal2 - triggers on an externally connected trigger source on the front panel –IQMag - triggers on the magnitude of the I/Q signal –IDEMod - triggers on the I/Q signal's demodulated I voltage –QDEMod - triggers on the I/Q signal's demodulated Q voltage –IINPut - triggers on the I channel's ADC voltage –QINPut - triggers on the Q channel's ADC voltage –AIQMag - triggers on the magnitude of the auxiliary receiver channel I/Q signal <p>*OPC should be used after requesting data. This will hold off any subsequent changes to the selected trigger source, until after the sweep is completed and the data is returned.</p> <p>Available ranges, and from mode to mode presets can vary</p>
Status Bits/OPC dependencies	The Status Operation Register bit 5 "Waiting for Trigger" is set at the same time as the Sweeping or Measuring bit is set. It is cleared when the trigger actually occurs (that is, after the trigger event occurs and all the applicable trigger criteria have been met). A corresponding pop-up message ("Waiting for trigger") is generated if no trigger signal appears after approximately 2 sec. This message goes away when a trigger signal appears.
Initial S/W Revision	Prior to A.02.00

More Information

The trigger menus let you select the trigger source and trigger settings for a sweep or measurement. In triggered operation (basically, any trigger source other than Free Run), the analyzer will begin a sweep or measurement only with the selected trigger conditions are met, generally when your trigger source signal meets the specified trigger level and polarity requirements. (In FFT measurements, the trigger controls when the data acquisition begins for FFT conversion.)

For each of the trigger sources, you may define a set of operational parameters or settings which will be applied when that source is selected as the current trigger source. Examples of these settings are Trigger Level, Trigger Delay, and Trigger Slope. You may apply different settings for each source; so, for example, you could have a Trigger Level of 1v for External 1 trigger and –10 dBm for Video trigger.

Once you have established the settings for a given trigger source, they generally will remain unchanged for that trigger source as you go from measurement to measurement within a Mode (although the settings do change as you go from Mode to Mode). Furthermore, the trigger settings within a Mode are the same for the **Trigger** menu, the **Gate Source** menu, and the **Sync Source** menu that is part of the **Periodic Timer Trigger Setup** menu. That is, if **Ext1** trigger level is set to 1v in the **Trigger** menu, it will appear as 1v in both the **Gate Source** and the **Sync Source** menus. For these reasons the trigger settings commands are not qualified with the measurement name, the way the trigger source commands are.

The settings setup menu can be accessed by pressing the key for the current trigger source a second time. For example, one press of Video selects the Video trigger as the source. The Video key becomes highlighted and the hollow arrow on the key turns black. Now a second press of the key takes you into the Video Trigger Setup menu.

Trigger Setup Parameters:

The following examples show trigger setup parameters using an external trigger source.

Example 1 illustrates the trigger conditions with negative slope and no trigger occurs during trigger Holdoff time.

Example 2 illustrates the trigger conditions with positive slope, trigger delay, and auto trigger time.

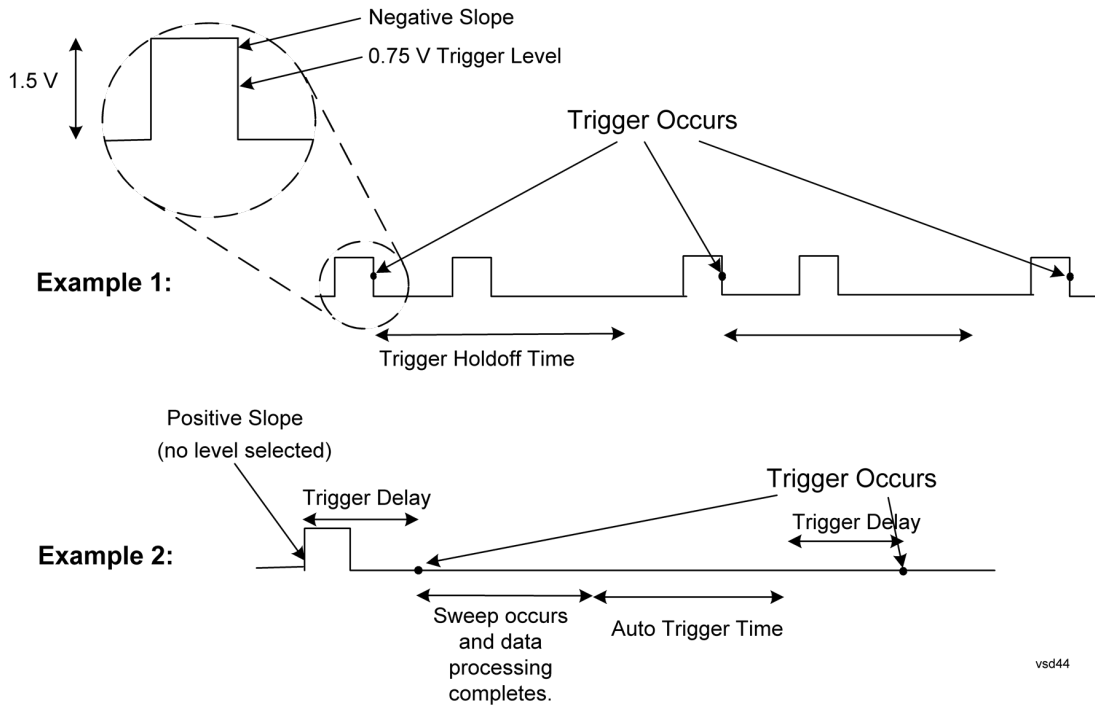

vsd44

Free Run

Pressing this key, when it is not selected, selects free-run triggering. Free run triggering occurs immediately after the sweep/measurement is initiated.

Key Path	Trigger
Example	TRIG:SOUR IMM Swept SA measurement TRIG:<meas>:SOUR IMM Measurements other than Swept SA
State Saved	Saved in instrument state
Status Bits/OPC dependencies	The Status Operation Register bit 5 "Waiting for Trigger" is set at the same time as the Sweeping or Measuring bit is set. It is cleared when the trigger actually occurs (that is, after the trigger event occurs and all the applicable trigger criteria have been met). A corresponding pop-up message ("Waiting for trigger") is generated if no trigger signal appears after approximately 2 sec. This message goes away when a trigger signal appears.
Initial S/W Revision	Prior to A.02.00

Video (IF Envelope)

Pressing this key, when it is not selected, selects the video signal as the trigger. The Video trigger condition is met when the video signal (the filtered and detected version of the input signal, including both RBW and VBW filtering) crosses the video trigger level.

NOTE

When the detector selected for all active traces is the average detector, the video signal for triggering does not include any VBW filtering.

The video trigger level is shown as a labeled line on the display. The line is displayed as long as video is the selected trigger source.

Pressing this key, when it is already selected, accesses the video trigger setup functions.

Key Path	Trigger
Example	TRIG:SOUR VID Swept SA measurement TRIG:<meas>:SOUR VID Measurements other than Swept SA
Notes	Log Plot and Spot Frequency measurements do not support Video Trigger
Dependencies	Video trigger is allowed in average detector mode.
State Saved	Saved in instrument state
Status Bits/OPC dependencies	The Status Operation Register bit 5 "Waiting for Trigger" is set at the same time as the Sweeping or Measuring bit is set. It is cleared when the trigger actually occurs (that is, after the trigger event occurs and all the applicable trigger criteria have been met). A corresponding pop-up message ("Waiting for trigger") is generated if no trigger signal appears after approximately 2 sec. This message goes away when a trigger signal appears.
Backwards Compatibility Notes	In the past, the Average detector was not available when Video triggering was on, and consequently, functions that set the detector to average (such as Marker Noise or Band/Intvl Power) were not available when the video trigger was on. Similarly, Video triggering was not available when the detector was Average. In the X-Series, these restrictions are removed.
Initial S/W Revision	Prior to A.02.00

Trigger Level

Sets a level for the video signal trigger. When the video signal crosses this level, with the chosen slope, the trigger occurs. This level is displayed with a horizontal line only if **Video** is the selected trigger source.

Key Path	Trigger, Video
Remote Command	:TRIGger[:SEquence]:VIDeo:LEVel <ampl> :TRIGger[:SEquence]:VIDeo:LEVel?
Example	TRIG:VID:LEV -40 dBm
Notes	When sweep type = FFT, the video trigger uses the amplitude envelope in a bandwidth wider than the FFT width as a trigger source. This might often be useful, but does not have the same relationship between the displayed trace and the trigger level as in swept triggering. Amplitude Corrections are not taken into account by the Video Trig Level. For example, if you have

given yourself effective gain with an amplitude correction factor, the Video Trigger will not fire until you have dropped the trigger line that far below the displayed signal level, rather than simply dropping it down to the displayed signal level.

Note that other corrections, specifically External Gain and Ref Level Offset, modify the actual trace data as it is taken and therefore ARE taken into account by Trig Level.

Couplings	This same level is used for the Video trigger source in the Trigger menu and for the Video selection in the Gate Source menu.
Preset	Set the Video Trigger Level -25 dBm on Preset. When the Video Trigger Level becomes the active function, if the value is off screen, set it to either the top or bottom of screen, depending on which direction off screen it was.
State Saved	Saved in instrument state
Min	-170 dBm
Max	+30 dBm
Default Unit	Depends on the current selected Y axis unit
Backwards Compatibility SCPI	:TRIGger[:SEquence]:IF:LEVel :TRIGger[:SEquence]:IF:LEVel?
Backwards Compatibility Notes	This alias is provided for backward compatibility with VSA/PSA comms apps.
Initial S/W Revision	Prior to A.02.00

Trig Slope

Controls the trigger polarity. It is set positive to trigger on a rising edge and negative to trigger on a falling edge.

Key Path	Trigger, Video
Remote Command	:TRIGger[:SEquence]:VIDeo:SLOPe POSitive NEGative :TRIGger[:SEquence]:VIDeo:SLOPe?
Example	TRIG:VID:SLOP NEG
Preset	POSitive
State Saved	Saved in instrument state
Backwards Compatibility SCPI	:TRIGger[:SEquence]:IF:SLOPe NEGative POSitive :TRIGger[:SEquence]:IF:SLOPe? For backward compatibility with VSA/PSA comms apps
Backwards Compatibility Notes	The legacy :TRIGger[:SEquence]:SLOPe command affects the slopes for the VID, LINE, EXT1, EXT2, and RFB triggers.
Initial S/W Revision	Prior to A.02.00

Remote Command	:TRIGger[:SEquence]:SLOPe POSitive NEGative :TRIGger[:SEquence]:SLOPe?
Example	TRIG:SLOP NEG
Preset	POSitive
State Saved	Saved in instrument state
Backwards Compatibility Notes	In ESA/PSA, the Trigger Slope was global to all triggers. In the X-Series, the slope can be set individually for each Trigger Source. For backward compatibility, the global SLOPe command updates all instances of trigger slope (VID, LINE, EXT1, EXT2, TV, RFB). The query returns the trigger slope setting of the currently selected trigger source.
Initial S/W Revision	Prior to A.02.00

Trig Delay

Controls a time delay during that the analyzer will wait to begin a sweep after meeting the trigger criteria. You can use negative delay to pre-trigger the instrument in the time domain or FFT, but not in swept spans.

Key Path	Trigger, Video
Remote Command	:TRIGger[:SEquence]:VIDeo:DELaY <time> :TRIGger[:SEquence]:VIDeo:DELaY? :TRIGger[:SEquence]:VIDeo:DELaY:STATe OFF ON 0 1 :TRIGger[:SEquence]:VIDeo:DELaY:STATe?
Example	TRIG:VID:DEL:STAT ON TRIG:VID:DEL 100 ms
Notes	Video trigger delay may be set to negative values, in time domain, FFT and even swept. It makes intuitive sense in time domain and works well in FFT mode where the bandwidth of the filter before the video trigger is about 1.25 span. In swept spans, negative settings of Trig Delay are treated as a zero setting within the internal hardware and the advisory message "Neg. Trig Delay unavailable in Swept Mode, zero delay used." is generated when such a delay is set.
Preset	Off, 1 us
State Saved	Saved in instrument state
Min	-150 ms
Max	+500 ms
Default Unit	s
Backwards Compatibility Notes	! For backward compatibility with VSA/PSA comms apps :TRIGger[:SEquence]:IF:DELaY :TRIGger[:SEquence]:DELaY The legacy :TRIGger[:SEquence]:DELaY command affects the delay for the VID, LINE, EXT1, EXT2, and RFB triggers.
Initial S/W Revision	Prior to A.02.00

Remote Command	:TRIGger[:SEquence]:DELay <time> :TRIGger[:SEquence]:DELay? :TRIGger[:SEquence]:DELay:STATE OFF ON 0 1 :TRIGger[:SEquence]:DELay:STATE?
Example	TRIG:DEL 1 ms
Preset	1 us
State Saved	Saved in instrument state
Backwards Compatibility Notes	In ESA/PSA, the Trigger Delay was global to all triggers. In the X-Series, the delay can be set individually for each Trigger Source. For backward compatibility, the global DELay command updates all instances of trigger slope (VID, LINE, EXT1, EXT2) except TV and RFBurst. The query returns the trigger delay setting of the currently selected trigger source.
Initial S/W Revision	Prior to A.02.00

Remote Command	:TRIGger[:SEquence]:OFFSet <time> :TRIGger[:SEquence]:OFFSet? :TRIGger[:SEquence]:OFFSet:STATE OFF ON 0 1 :TRIGger[:SEquence]:OFFSet:STATE?
Example	TRIG:OFFS ON TRIG:OFFS -100 ms
Notes	These are ESA commands for trigger offset that allowed you to use a positive or negative delay when in zero span and in a Res BW >= 1 kHz. For ESA compatibility, X-series analyzers keep track of this offset and adds it to the Trigger Delay for VIDEo, LINE, EXTernal1 or EXTernal2 whenever the value is sent to the hardware, if in Zero Span and RBW >= 1 kHz.
Preset	Off, 0 s
State Saved	Saved in instrument state
Min	-11 s
Max	+11 s
Initial S/W Revision	Prior to A.02.00

External 1

Pressing this key, when it is not selected, selects an external input signal as the trigger. A new sweep/measurement will start when the external trigger condition is met using the external 1 input connector on the rear panel.

Pressing this key, when it is already selected, accesses the external 1 trigger setup menu.

Key Path	Trigger
Example	TRIG:SOUR EXT1 Swept SA measurement TRIG:<meas>:SOUR EXT1 Measurements other than Swept SA

Dependencies	Grayed out if in use by Point Trigger in the Source Setup menu. Forced to Free Run if already selected and Point Trigger is set to External 1.
State Saved	Saved in instrument state
Status Bits/OPC dependencies	The Status Operation Register bit 5 "Waiting for Trigger" is set at the same time as the Sweeping or Measuring bit is set. It is cleared when the trigger actually occurs (that is, after the trigger event occurs and all the applicable trigger criteria have been met). A corresponding pop-up message ("Waiting for trigger") is generated if no trigger signal appears after approximately 2 sec. This message goes away when a trigger signal appears.
Initial S/W Revision	Prior to A.02.00

Trigger Level

Sets the value where the external 1 trigger input will trigger a new sweep/measurement.

Key Path	Trigger, External 1
Remote Command	:TRIGger[:SEquence]:EXTernal1:LEVel <level> :TRIGger[:SEquence]:EXTernal1:LEVel?
Example	TRIG:EXT1:LEV 0.4 V
Couplings	This same level is used for the Ext1 trigger source in the Trigger menu, for the Ext1 selection in the Periodic Timer sync source (in the Trigger menu and in the Gate Source menu), and also for the Ext1 selection in the Gate Source menu.
Preset	1.2 V
State Saved	Saved in instrument state
Min	-5 V
Max	5 V
Default Unit	V
Backwards Compatibility SCPI	:TRIGger[:SEquence]:EXTernal:LEVel For backward compatibility, the parameter EXTernal is mapped to EXTernal1
Backwards Compatibility SCPI	:TRIGger[:SEquence]:FRAMe:EXTernal1:LEVel
Initial S/W Revision	Prior to A.02.00

Trig Slope

Controls the trigger polarity. It is set positive to trigger on a rising edge and negative to trigger on a falling edge.

Key Path	Trigger, External 1
Remote Command	:TRIGger[:SEquence]:EXTernal1:SLOPe POSitive NEGative

	:TRIGger[:SEquence]:EXTernal1:SLOPe?
Example	TRIG:EXT1:SLOP NEG
Couplings	This same slope is used in the Ext1 selection for the trigger source in the Trigger menu and for the period timer sync source (in the Trigger menu and in the Gate Source menu).
Preset	POSitive
State Saved	Saved in instrument state
Backwards Compatibility SCPI	:TRIGger[:SEquence]:EXTernal:SLOPe For backward compatibility, the parameter EXTernal is mapped to EXTernal1
Backwards Compatibility SCPI	:TRIGger[:SEquence]:FRAMe:EXTernal1:SLOPe
Backwards Compatibility Notes	The legacy :TRIGger[:SEquence]:SLOPe command affects the slopes for the VID, LINE, EXT1, EXT2, and RFB triggers.
Initial S/W Revision	Prior to A.02.00

Trig Delay

Controls a time delay during which the analyzer will wait to begin a sweep after meeting the trigger criteria. You can use negative delay to pre-trigger the instrument in time domain or FFT, but not in swept spans.

Key Path	Trigger, External 1
Remote Command	:TRIGger[:SEquence]:EXTernal1:DELAy <time> :TRIGger[:SEquence]:EXTernal1:DELAy? :TRIGger[:SEquence]:EXTernal1:DELAy:STATe OFF ON 0 1 :TRIGger[:SEquence]:EXTernal1:DELAy:STATe?
Example	TRIG:EXT1:DEL:STAT ON TRIG:EXT1:DEL 100 ms
Notes	Video trigger delay may be set to negative values, in time domain, FFT and even swept. It makes intuitive sense in time domain and works well in FFT mode where the bandwidth of the filter before the video trigger is about 1.25 span. In swept spans, negative settings of Trig Delay are treated as a zero setting within the internal hardware and the advisory message "Neg. Trig Delay unavailable in Swept Mode, zero delay used." is generated when such a delay is set.
Preset	Off, 1.000 us
State Saved	Saved in instrument state
Min	-150 ms
Max	+500 ms
Default Unit	s
Backwards Compatibility SCPI	:TRIGger[:SEquence]:EXTernal:DELAy For backward compatibility, the parameter EXTernal is mapped to EXTernal1
Backwards Compatibility	The legacy :TRIGger[:SEquence]:DELAy command affects the delay for the VID, LINE, EXT1, EXT2,

Notes	and RFB triggers. The legacy :TRIGger[:SEQuence]:OFFSet command is supported for the VIDEO, LINE, EXT1, and EXT2 triggers.
Initial S/W Revision	Prior to A.02.00

Zero Span Delay Comp On/Off

In zero span, there is a natural delay in the signal path, which comes from the RBW filter. This is usually desirable, as it allows you to trigger on events and also see those events, because the signal is delayed from the trigger event. However, in some cases it is desirable to eliminate this delay, so that trigger events line up exactly with the zero time point in zero span. You can use the **Zero Span Delay Comp On/Off** feature to enable or disable zero span delay compensation.

Key Path	Trigger, External 1
Remote Command	:TRIGger[:SEQuence]:EXTernal1:DELAy:COMPensation OFF ON 0 1 :TRIGger[:SEQuence]:EXTernal1:DELAy:COMPensation?
Example	TRIG:EXT1:DEL:COMP ON
Dependencies	No effect except in zero-span, but not locked out in nonzero spans. Blanked in modes that do not support zero-span measurements. If the SCPI command is sent when the key is blanked, an error is returned: -221, "Settings conflict; Feature not supported for this measurement" In analyzers shipping N9060A, this feature requires N9060A-7FP.
Preset	OFF
State Saved	Saved in instrument state
Initial S/W Revision	A.11.00

External 2

Pressing this key, when it is not selected, selects an external input signal as the trigger. A new sweep/measurement will start when the external trigger condition is met using the external 2 input connector. The external trigger 2 input connector is on the rear panel.

Pressing this key, when it is already selected, accesses the external 2 trigger setup menu.

Key Path	Trigger
Example	TRIG:SOUR EXT2 Swept SA measurement TRIG:<meas>:SOUR EXT2 Measurements other than Swept SA
Dependencies	In some models, there is no second External input. In these models, the External 2 key is blanked and the EXTernal2 parameter will generate a "Hardware missing; Not available for this model number" message. Grayed out if in use by Point Trigger in the Source Setup menu. Forced to Free Run if already selected and Point Trigger is set to External 2.

State Saved	Saved in instrument state
Status Bits/OPC dependencies	The Status Operation Register bit 5 "Waiting for Trigger" is set at the same time as the Sweeping or Measuring bit is set. It is cleared when the trigger actually occurs (that is, after the trigger event occurs and all the applicable trigger criteria have been met). A corresponding pop-up message ("Waiting for trigger") is generated if no trigger signal appears after approximately 2 sec. This message goes away when a trigger signal appears.
Initial S/W Revision	Prior to A.02.00
Modified at S/W Revision	A.03.00

Trigger Level

Sets the value where the external 2 trigger input will trigger a new sweep/measurement.

Key Path	Trigger, External 2
Remote Command	:TRIGger[:SEquence]:EXTernal2:LEVel :TRIGger[:SEquence]:EXTernal2:LEVel?
Example	TRIG:EXT2:LEV 1.1 V
Couplings	This same level is used for the Ext2 trigger source in the Trigger menu, for the Ext2 selection in the Periodic Timer sync source (in the Trigger menu and in the Gate Source menu), and also for the Ext2 selection in the Gate Source menu.
Preset	1.2 V
State Saved	Saved in instrument state
Min	-5 V
Max	5 V
Default Unit	V
Backwards Compatibility SCPI	:TRIGger[:SEquence]:FRAMe:EXTernal2:LEVel
Initial S/W Revision	Prior to A.02.00

Trig Slope

Controls the trigger polarity. It is set positive to trigger on a rising edge and negative to trigger on a falling edge.

Key Path	Trigger, External 2
Remote Command	:TRIGger[:SEquence]:EXTernal2:SLOPe POSitive NEGative :TRIGger[:SEquence]:EXTernal2:SLOPe?
Example	TRIG:EXT2:SLOP NEG
Couplings	This same slope is used in the Ext2 selection for the trigger source in the Trigger menu and for the period timer sync source (in the Trigger menu and in the Gate Source menu).

Preset	POSitive
State Saved	Saved in instrument state
Backwards Compatibility SCPI	:TRIGger[:SEQuence]:FRAMe:EXTernal2:SLOPe
Backwards Compatibility Notes	The legacy :TRIGger[:SEQuence]:SLOPe command affects the slopes for the VID, LINE, EXT1, EXT2, and RFB triggers.
Initial S/W Revision	Prior to A.02.00

Trig Delay

Controls a time delay during which the analyzer will wait to begin a sweep after meeting the trigger criteria. You can use negative delay to pre-trigger the instrument in time domain or FFT, but not in swept spans.

Key Path	Trigger, External 2
Remote Command	:TRIGger[:SEQuence]:EXTernal2:DELay <time> :TRIGger[:SEQuence]:EXTernal2:DELay? :TRIGger[:SEQuence]:EXTernal2:DELay:STATe OFF ON 0 1 :TRIGger[:SEQuence]:EXTernal2:DELay:STATe?
Example	TRIG:EXT2:DEL:STAT ON TRIG:EXT2:DEL 100 ms
Notes	Video trigger delay may be set to negative values, in time domain, FFT and even swept. It makes intuitive sense in time domain and works well in FFT mode where the bandwidth of the filter before the video trigger is about 1.25 span. In swept spans, negative settings of Trig Delay are treated as a zero setting within the internal hardware and the advisory message "Neg. Trig Delay unavailable in Swept Mode, zero delay used." is generated when such a delay is set.
Preset	Off, 1.000 us
State Saved	Saved in instrument state
Min	-150 ms
Max	500 ms
Default Unit	s
Backwards Compatibility Notes	The legacy :TRIGger[:SEQuence]:DELay command affects the delay for the VID, LINE, EXT1, EXT2, and RFB triggers. The legacy :TRIGger[:SEQuence]:OFFSet command is supported for the VIDEo, LINE, EXT1, and EXT2 triggers.
Initial S/W Revision	Prior to A.02.00

Zero Span Delay Comp On/Off

In zero span, there is a natural delay in the signal path, which comes from the RBW filter. This is usually desirable, as it allows you to trigger on events and also see those events, because the signal is delayed

from the trigger event. However, in some cases it is desirable to eliminate this delay, so that trigger events line up exactly with the zero time point in zero span. You can use the **Zero Span Delay Comp On/Off** feature to enable or disable zero span delay compensation.

Key Path	Trigger, External 2
Remote Command	:TRIGger[:SEquence]:EXTernal2:DELay:COMPensation OFF ON 0 1 :TRIGger[:SEquence]:EXTernal2:DELay:COMPensation?
Example	TRIG:EXT2:DEL:COMP ON
Dependencies	No effect except in zero-span, but not locked out in nonzero spans. Blanked in modes that do not support zero-span measurements. If the SCPI command is sent when the key is blanked, an error is returned: -221, "Settings conflict; Feature not supported for this measurement" In analyzers shipping N9060A, this feature requires N9060A-7FP.
Preset	OFF
State Saved	Saved in instrument state
Initial S/W Revision	A.11.00

RF Burst

Pressing this key, when it is not selected, selects the RF Burst as the trigger. A new sweep/measurement will start when an RF burst envelope signal is identified from the signal at the RF Input connector. Pressing this key, when it is already selected, accesses the RF Burst trigger setup menu.

In some models, a variety of burst trigger circuitry is available, resulting in various available burst trigger bandwidths. The analyzer automatically chooses the appropriate trigger path based on the hardware configuration and other settings of the analyzer.

Key Path	Trigger
Example	TRIG:SOUR RFB Swept SA measurement TRIG:<meas>:SOUR RFB Measurements other than Swept SA
State Saved	Saved in instrument state
Status Bits/OPC dependencies	The Status Operation Register bit 5 "Waiting for Trigger" is set at the same time as the Sweeping or Measuring bit is set. It is cleared when the trigger actually occurs (that is, after the trigger event occurs and all the applicable trigger criteria have been met). A corresponding pop-up message ("Waiting for trigger") is generated if no trigger signal appears after approximately 2 sec. This message goes away when a trigger signal appears.
Backwards Compatibility Notes	The legacy command: :TRIGger[:SEquence]:RFBurst:FSElectivity[:STATe] OFF ON 0 1 is not supported in the X-Series, as the hardware to do Frequency Selective burst triggers does not exist in X-Series.
Initial S/W Revision	Prior to A.02.00
Modified at S/W Revision	A.04.00

Absolute Trigger Level

Sets the absolute trigger level for the RF burst envelope.

When using the External Mixing path, the Absolute Trigger Level is uncalibrated because the factory default was set to accommodate the expected IF levels for the RF path.

Key Path	Trigger, RF Burst
Scope	Meas Global
Remote Command	:TRIGger[:SEquence]:RFBurst:LEVel:ABSolute <ampl> :TRIGger[:SEquence]:RFBurst:LEVel:ABSolute?
Example	TRIG:RFB:LEV:ABS 10 dBm sets the trigger level of the RF burst envelope signal to the absolute level of 10 dBm
Notes	Sending this command does not switch the setting from relative to absolute; to switch it you need to send the :TRIGger[:SEquence]:RFBurst:LEVel:TYPE command, below. Amplitude Corrections are not taken into account by the Absolute Trigger Level. For example, if you have given yourself effective gain with an amplitude correction factor, the Absolute Trigger will not fire until you have set the trigger level that far below the displayed signal level, rather than simply to the displayed signal level. This is only true for Amplitude Corrections, not External Gain or Ref Level Offset functions. If mode is Bluetooth, the default value is -50 dBm.
Couplings	This same level is used for the RF Burst trigger source in the Trigger menu, for the RF Burst selection in the Periodic Timer sync source (in the Trigger menu and in the Gate Source menu), and also for the RF Burst selection in the Gate Source menu
Preset	-20 dBm
State Saved	Saved in instrument state
Min	-200 dBm
Max	100 dBm
Default Unit	depends on the current selected Y-Axis unit
Backwards Compatibility SCPI	:TRIGger[:SEquence]:FRAME:RFBurst:LEVel:ABSolute
Initial S/W Revision	Prior to A.02.00
Modified at S/W Revision	A.04.00

Key Path	Trigger, RF Burst
Remote Command	:TRIGger[:SEquence]:RFBurst:LEVel:TYPE ABSolute RELative :TRIGger[:SEquence]:RFBurst:LEVel:TYPE?
Example	TRIG:RFB:LEV:TYPE REL sets the trigger level type of the RF burst trigger to Relative.
Preset	ABSolute
State Saved	Saved in instrument state

Initial S/W Revision	Prior to A.02.00
Modified at S/W Revision	A.04.00

Relative Trigger Level

Sets the relative trigger level for the RF burst envelope.

In some models, the relative burst trigger function is implemented in hardware. In other models, without the advanced triggering hardware required, the relative burst trigger function is implemented in software in some measurements, and is unavailable in other measurements.

When implemented in software, the relative RF Burst trigger function is implemented as follows:

1. The measurement starts with the absolute RF Burst trigger setting. If it cannot get a trigger with that level, auto trigger fires and the acquisition starts anyway. After the acquisition, the measurement searches for the peak in the acquired waveform and saves it.
2. Now, in the next cycle of the measurement, the measurement determines a new absolute RF Burst level based on the peak value from the first measurement and the Relative RF Burst Trigger Level (always 0 or negative dB) set by the user. The following formula is used:
3. absolute RF Burst level = peak level of the previous acquisition + relative RF Burst level
4. If the new absolute RF Burst level differs from the previous by more than 0.5 dB, the new level is sent to the hardware; otherwise it is not updated (to avoid slowing down the acquisition)

Steps 2 and 3 repeat for subsequent measurements.

Key Path	Trigger, RF Burst
Scope	Meas Global
Remote Command	:TRIGger[:SEQuence]:RFBurst:LEVel:RELative <rel_ampl> :TRIGger[:SEQuence]:RFBurst:LEVel:RELative?
Example	TRIG:RFB:LEV:REL -10 dB sets the trigger level of the RF burst envelope signal to the relative level of -10 dB
Notes	Sending this command does not switch the setting from absolute to relative; to switch it you need to send the :TRIGger[:SEQuence]:RFBurst:LEVel:TYPE command, above. The relative trigger level is not available in some measurements. In those measurements the RELative parameter, and the :TRIGger[:SEQuence]:RFBurst:LEVel:TYPE command (above), will generate an error if sent.
Dependencies	This key is grayed out and Absolute Trigger Level selected if the required hardware is not present in your analyzer and the current measurement does not support Relative triggering.
Preset	-6 dB GSM: -25 dB
State Saved	Saved in instrument state
Min	-45 dB

Max	0 dB
Default Unit	dB or dBc
Backwards Compatibility SCPI	:TRIGger[:SEquence]:RFBurst:LEVel This legacy command is aliased to :TRIGger[:SEquence]:RFBurst:LEVel:RELative because the PSA had ONLY relative burst triggering
Initial S/W Revision	Prior to A.02.00
Modified at S/W Revision	A.04.00

Trigger Slope

It is set positive to trigger on a rising edge and negative to trigger on a falling edge.

Key Path	Trigger, RF Burst
Remote Command	:TRIGger[:SEquence]:RFBurst:SLOPe POSitive NEGative :TRIGger[:SEquence]:RFBurst:SLOPe?
Example	TRIG:RFB:SLOP NEG
Couplings	This same slope is used in the RF Burst selection for the trigger source in the Trigger menu and for the period timer sync source (in the Trigger menu and in the Gate Source menu).
Preset	POSitive
State Saved	Saved in instrument state
Backwards Compatibility SCPI	:TRIGger[:SEquence]:FRAME:RFBurst:SLOPe
Backwards Compatibility Notes	The legacy :TRIGger[:SEquence]:SLOPe command affects the slopes for the VID, LINE, EXT1, EXT2, and RFB triggers.
Initial S/W Revision	Prior to A.02.00

Trig Delay

Controls a time delay during which the analyzer will wait to begin a sweep after meeting the trigger criteria. You can use negative delay to pre-trigger the instrument in time domain or FFT, but not in swept spans.

Key Path	Trigger, RF Burst
Remote Command	:TRIGger[:SEquence]:RFBurst:DELay <time> :TRIGger[:SEquence]:RFBurst:DELay? :TRIGger[:SEquence]:RFBurst:DELay:STATe OFF ON 0 1 :TRIGger[:SEquence]:RFBurst:DELay:STATe?
Example	TRIG:RFB:DEL:STAT ON TRIG:RFB:DEL 100 ms

Notes	Video trigger delay may be set to negative values, in time domain, FFT and even swept. It makes intuitive sense in time domain and works well in FFT mode where the bandwidth of the filter before the video trigger is about 1.25 span. In swept spans, negative settings of Trig Delay are treated as a zero setting within the internal hardware and the advisory message "Neg. Trig Delay unavailable in Swept Mode, zero delay used." is generated when such a delay is set.
Preset	Off, 1.000 us
State Saved	Saved in instrument state
Min	-150 ms
Max	500 ms
Default Unit	s
Backwards Compatibility Notes	The legacy :TRIGger[:SEQuence]:DELAy command affects the delay for the VID, LINE, EXT1, EXT2, and RFB triggers.
Initial S/W Revision	Prior to A.02.00

Periodic Timer (Frame Trigger)

Pressing this key, when it is not selected, selects the internal periodic timer signal as the trigger. Triggering occurrences are set by the **Period** parameter, which is modified by the **Sync Source** and **Offset**. Pressing this key, when it is already selected, accesses the periodic timer trigger setup functions.

If you do not have a sync source selected (it is Off), then the internal timer will not be synchronized with any external timing events.

Key Path	Trigger
Example	TRIG:SOUR FRAM Swept SA measurement TRIG:<meas>:SOUR FRAM Measurements other than Swept SA
State Saved	Saved in instrument state
Readback	[Sync: <value of Sync Source>], for example, [Sync: External 1]
Status Bits/OPC dependencies	The Status Operation Register bit 5 "Waiting for Trigger" is set at the same time as the Sweeping or Measuring bit is set. It is cleared when the trigger actually occurs (that is, after the trigger event occurs and all the applicable trigger criteria have been met). A corresponding pop-up message ("Waiting for trigger") is generated if no trigger signal appears after approximately 2 sec. This message goes away when a trigger signal appears.
Initial S/W Revision	Prior to A.02.00

Periodic Timer Triggering:

This feature selects the internal periodic timer signal as the trigger. Trigger occurrences are set by the **Periodic Timer** parameter, which is modified by the **Sync Source** and **Offset**.

The figure below shows the action of the periodic timer trigger. Before reviewing the figure, we'll explain some uses for the periodic trigger.

A common application is measuring periodic burst RF signals for which a trigger signal is not easily available. For example, we might be measuring a TDMA radio which bursts every 20 ms. Let's assume that the 20 ms period is very consistent. Let's also assume that we do not have an external trigger source available that is synchronized with the period, and that the signal-to-noise ratio of the signal is not high enough to provide a clean RF burst trigger at all of the analysis frequencies. For example, we might want to measure spurious transmissions at an offset from the carrier that is larger than the bandwidth of the RF burst trigger. In this application, we can set the Periodic Timer to a 20.00 ms period and adjust the offset from that timer to position our trigger just where we want it. If we find that the 20.00 ms is not exactly right, we can adjust the period slightly to minimize the drift between the period timer and the signal to be measured.

A second way to use this feature would be to use **Sync Source** temporarily, instead of **Offset**. In this case, we might tune to the signal in a narrow span and use the RF Burst trigger to synchronize the periodic timer. Then we would turn the sync source off so that it would not miss-trigger. Miss-triggering can occur when we are tuned so far away from the RF burst trigger that it is no longer reliable.

A third example would be to synchronize to a signal that has a reference time element of much longer period than the period of interest. In some CDMA applications, it is useful to look at signals with a short periodicity, by synchronizing that periodicity to the "even-second clock" edge that happens every two seconds. Thus, we could connect the even-second clock trigger to Ext1 and use then Ext1 as the sync source for the periodic timer.

The figure below illustrates this third example. The top trace represents the even-second clock. It causes the periodic timer to synchronize with the leading edge shown. The analyzer trigger occurs at a time delayed by the accumulated offset from the period trigger event. The periodic timer continues to run, and triggers continue to occur, with a periodicity determined by the analyzer time base. The timer output (labeled "late event") will drift away from its ideal time due to imperfect matching between the time base of the signal being measured and the time base of the analyzer, and also because of imperfect setting of the period parameter. But the synchronization is restored on the next even-second clock event. ("Accumulated offset" is described in the in the **Offset** function section.)

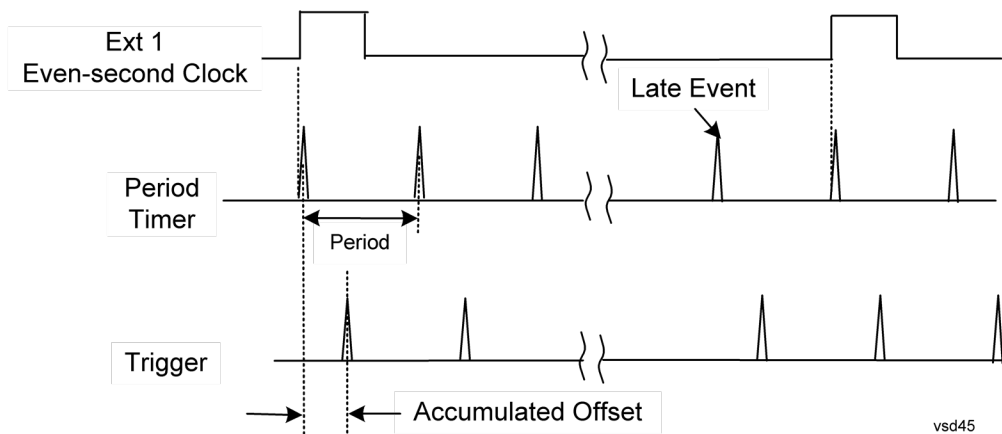

Period

Sets the period of the internal periodic timer clock. For digital communications signals, this is usually set to the frame period of your current input signal. In the case that sync source is not set to OFF, and the external sync source rate is changed for some reason, the periodic timer is synchronized at the every external synchronization pulse by resetting the internal state of the timer circuit.

Key Path	Trigger, Periodic Timer
Remote Command	:TRIGger[:SEquence]:FRAMe:PERiod <time> :TRIGger[:SEquence]:FRAMe:PERiod?
Example	TRIG:FRAM:PER 100 ms
Dependencies	The invalid data indicator turns on when the period is changed, until the next sweep/measurement completes.
Couplings	The same period is used in the Gate Source selection of the period timer.
Preset	20 ms GSM: 4.615383
State Saved	Saved in instrument state
Min	100.000 ns
Max	559.0000 ms
Default Unit	S
Initial S/W Revision	Prior to A.02.00

Offset

Adjusts the accumulated offset between the periodic timer events and the trigger event. Adjusting the accumulated offset is different than setting an offset, and requires explanation.

The periodic timer is usually not synchronized with any external events, so the timing of its output events has no absolute meaning. Since the timing relative to external events (RF signals) is important, you need to be able to adjust (offset) it. However, you have no direct way to see when the periodic timer events occur. All that you can see is the trigger timing. When you want to adjust the trigger timing, you will be changing the internal offset between the periodic timer events and the trigger event. Because the absolute value of that internal offset is unknown, we will just call that the accumulated offset. Whenever the Offset parameter is changed, you are changing that accumulated offset. You can reset the displayed offset using Reset Offset Display. Changing the display does not change the value of the accumulated offset, and you can still make additional changes to accumulated offset.

To avoid ambiguity, we define that an increase in the "offset" parameter, either from the knob or the SCPI adjust command, serves to delay the timing of the trigger event.

Key Path	Trigger, Periodic Timer
Remote Command	:TRIGger[:SEquence]:FRAMe:OFFSet <time> :TRIGger[:SEquence]:FRAMe:OFFSet?
Example	TRIG:FRAM:OFFS 1.2 ms
Notes	The front panel interface (for example, the knob), and this command, adjust the accumulated offset, which is shown on the active function display. However, the actual amount sent to the hardware each time the offset is updated is the delta value, that is, the current accumulated offset value minus the previous accumulated offset value. Note that the accumulated offset value is essentially arbitrary; it represents the accumulated offset from the last time the offset was zeroed (with the Reset Offset Display key).

	<p>Note that this command does not change the period of the trigger waveform. Note also that Offset is used only when the sync source is set to OFF, otherwise delay is used, see section "Trig Delay" on page 251.</p> <p>An increase in the "offset" parameter, either from the knob or the SCPI adjust command, serves to delay the timing of the trigger event.</p>
Notes	<p>When the SCPI command is sent the value shown on the key (and the Active Function, if this happens to be the active function) is updated with the new value. However, the actual amount sent to the hardware is the delta value, that is, the current accumulated offset value minus the previous accumulated offset value.</p> <p>The SCPI query simply returns the value currently showing on the key.</p>
Dependencies	The invalid data indicator turns on when the offset is changed, until the next sweep/measurement completes.
Couplings	The same offset is used in the Gate Source selection of the period timer.
Preset	0 s
State Saved	Saved in instrument state
Min	-10.000 s
Max	10.000 s
Default Unit	S
Initial S/W Revision	Prior to A.02.00

Offset Adjust (Remote Command Only)

This remote command does not work at all like the related front panel keys. This command lets you advance the phase of the frame trigger by the amount you specify.

It does not change the period of the trigger waveform. If the command is sent multiple times, it advances the phase of the frame trigger an additional amount each time it is sent. Negative numbers are permitted.

Remote Command	<code>:TRIGger[:SEquence]:FRAMe:ADJust <time></code>
Example	<code>TRIG:FRAM:ADJ 1.2 ms</code>
Notes	<p>Note also that Offset is used only when the sync source is set to OFF, otherwise delay is used, see section "Trig Delay" on page 251</p> <p>An increase in the "offset" parameter, either from the knob or the SCPI adjust command, serves to delay the timing of the trigger event.</p>
Notes	<p>The front panel interface (for example, the knob) and the <code>:TRIG:FRAM:OFFS</code> command adjust the accumulated offset, which is shown on the active function display. However, the actual amount sent to the hardware is the delta value, that is, the current offset value minus the previous offset value.</p> <p>When the SCPI command is sent the value shown on the key (and the Active Function, if this happens to be the active function) is updated by increasing it (or decreasing it if the value sent is negative) by the amount specified in the SCPI command.</p> <p>This is a "command only" SCPI command, with no query.</p>
Dependencies	The invalid data indicator turns on when the offset is changed, until the next sweep/measurement completes.

Couplings	The same offset is used in the Gate Source selection of the period timer.
Preset	0 s
State Saved	Saved in instrument state
Min	-10.000 s
Max	10.000 s
Default Unit	S
Initial S/W Revision	Prior to A.02.00

Reset Offset Display

Resets the value of the periodic trigger offset display setting to 0.0 seconds. The current displayed trigger location may include an offset value defined with the **Offset** key. Pressing this key redefines the currently displayed trigger location as the new trigger point that is 0.0 s offset. The **Offset** key can then be used to add offset relative to this new timing.

Key Path	Trigger, Periodic Timer
Remote Command	:TRIGger[:SEquence]:FRAMe:OFFSet:DISPlay:RESet
Example	TRIG:FRAM:OFFS:DISP:RES
Initial S/W Revision	Prior to A.02.00

Sync Source

Selects a signal source for you to synchronize your periodic timer trigger to, otherwise you are triggering at some arbitrary location in the frame. Synchronization reduces the precision requirements on the setting of the period.

For convenience you may adjust the level and slope of the selected sync source in a conditional branch setup menu accessed from the Sync Source menu. Note that these settings match those in the **Trigger** and **Gate Source** menus; that is, each trigger source has only one value of level and slope, regardless of which menu it is accessed from.

Key Path	Trigger, Periodic Timer
Remote Command	:TRIGger[:SEquence]:FRAMe:SYNC EXTernal1 EXTernal2 RFBurst OFF :TRIGger[:SEquence]:FRAMe:SYNC?
Example	TRIG:FRAM:SYNC EXT2
Dependencies	In some models, there is no second External input. In these models, the External 2 key is blanked and the EXTernal2 parameter will generate a "Hardware missing; Not available for this model number" message.
Preset	Off GSM/EDGE, MSR,LTE,LTETDD: RFBurst

State Saved	Saved in instrument state
Readback	The current setting is read back to this key and it is also Readback to the previous Periodic Timer trigger key.
Backwards Compatibility SCPI	:TRIGger[:SEquence]:FRAMe:SYNC EXTernal For backward compatibility, the parameter EXTernal is mapped to EXTernal1
Initial S/W Revision	Prior to A.02.00
Modified at S/W Revision	A.03.00, A.14.00

Off

Turns off the sync source for your periodic trigger. With the sync source off, the timing will drift unless the signal source frequency is locked to the analyzer frequency reference.

Key Path	Trigger, Periodic Timer, Sync Source
Example	TRIG:FRAM:SYNC OFF
Readback	Off
Initial S/W Revision	Prior to A.02.00

External 1

Pressing this key, when it is not selected, selects an external input signal as the trigger. A new sweep/measurement will start when the external trigger condition is met using the external 1 input connector on the rear panel.

Pressing this key, when it is already selected, accesses the external 1 trigger setup menu.

Key Path	Trigger
Example	TRIG:SOUR EXT1 Swept SA measurement TRIG:<meas>:SOUR EXT1 Measurements other than Swept SA
Dependencies	Grayed out if in use by Point Trigger in the Source Setup menu. Forced to Free Run if already selected and Point Trigger is set to External 1.
State Saved	Saved in instrument state
Status Bits/OPC dependencies	The Status Operation Register bit 5 "Waiting for Trigger" is set at the same time as the Sweeping or Measuring bit is set. It is cleared when the trigger actually occurs (that is, after the trigger event occurs and all the applicable trigger criteria have been met). A corresponding pop-up message ("Waiting for trigger") is generated if no trigger signal appears after approximately 2 sec. This message goes away when a trigger signal appears.
Initial S/W Revision	Prior to A.02.00

Trigger Level

Sets the value where the external 1 trigger input will trigger a new sweep/measurement.

Key Path	Trigger, External 1
Remote Command	:TRIGger[:SEquence]:EXTernal1:LEVel <level> :TRIGger[:SEquence]:EXTernal1:LEVel?
Example	TRIG:EXT1:LEV 0.4 V
Couplings	This same level is used for the Ext1 trigger source in the Trigger menu, for the Ext1 selection in the Periodic Timer sync source (in the Trigger menu and in the Gate Source menu), and also for the Ext1 selection in the Gate Source menu.
Preset	1.2 V
State Saved	Saved in instrument state
Min	-5 V
Max	5 V
Default Unit	V
Backwards Compatibility SCPI	:TRIGger[:SEquence]:EXTernal:LEVel For backward compatibility, the parameter EXTernal is mapped to EXTernal1
Backwards Compatibility SCPI	:TRIGger[:SEquence]:FRAME:EXTernal1:LEVel
Initial S/W Revision	Prior to A.02.00

Trig Slope

Controls the trigger polarity. It is set positive to trigger on a rising edge and negative to trigger on a falling edge.

Key Path	Trigger, External 1
Remote Command	:TRIGger[:SEquence]:EXTernal1:SLOPe POSitive NEGative :TRIGger[:SEquence]:EXTernal1:SLOPe?
Example	TRIG:EXT1:SLOP NEG
Couplings	This same slope is used in the Ext1 selection for the trigger source in the Trigger menu and for the period timer sync source (in the Trigger menu and in the Gate Source menu).
Preset	POSitive
State Saved	Saved in instrument state
Backwards Compatibility SCPI	:TRIGger[:SEquence]:EXTernal:SLOPe For backward compatibility, the parameter EXTernal is mapped to EXTernal1
Backwards Compatibility SCPI	:TRIGger[:SEquence]:FRAME:EXTernal1:SLOPe
Backwards Compatibility Notes	The legacy :TRIGger[:SEquence]:SLOPe command affects the slopes for the VID, LINE, EXT1, EXT2, and RFB triggers.
Initial S/W Revision	Prior to A.02.00

External 2

Pressing this key, when it is not selected, selects an external input signal as the trigger. A new sweep/measurement will start when the external trigger condition is met using the external 2 input connector. The external trigger 2 input connector is on the rear panel.

Pressing this key, when it is already selected, accesses the external 2 trigger setup menu.

Key Path	Trigger
Example	TRIG:SOUR EXT2 Swept SA measurement TRIG:<meas>:SOUR EXT2 Measurements other than Swept SA
Dependencies	In some models, there is no second External input. In these models, the External 2 key is blanked and the EXTERNAL2 parameter will generate a "Hardware missing; Not available for this model number" message. Grayed out if in use by Point Trigger in the Source Setup menu. Forced to Free Run if already selected and Point Trigger is set to External 2.
State Saved	Saved in instrument state
Status Bits/OPC dependencies	The Status Operation Register bit 5 "Waiting for Trigger" is set at the same time as the Sweeping or Measuring bit is set. It is cleared when the trigger actually occurs (that is, after the trigger event occurs and all the applicable trigger criteria have been met). A corresponding pop-up message ("Waiting for trigger") is generated if no trigger signal appears after approximately 2 sec. This message goes away when a trigger signal appears.
Initial S/W Revision	Prior to A.02.00
Modified at S/W Revision	A.03.00

Trigger Level

Sets the value where the external 2 trigger input will trigger a new sweep/measurement.

Key Path	Trigger, External 2
Remote Command	:TRIGger[:SEquence]:EXTernal2:LEVel :TRIGger[:SEquence]:EXTernal2:LEVel?
Example	TRIG:EXT2:LEV 1.1 V
Couplings	This same level is used for the Ext2 trigger source in the Trigger menu, for the Ext2 selection in the Periodic Timer sync source (in the Trigger menu and in the Gate Source menu), and also for the Ext2 selection in the Gate Source menu.
Preset	1.2 V
State Saved	Saved in instrument state
Min	-5 V
Max	5 V
Default Unit	V

Backwards Compatibility SCPI	:TRIGger[:SEquence]:FRAMe:EXTernal2:LEVel
Initial S/W Revision	Prior to A.02.00

Trig Slope

Controls the trigger polarity. It is set positive to trigger on a rising edge and negative to trigger on a falling edge.

Key Path	Trigger, External 2
Remote Command	:TRIGger[:SEquence]:EXTernal2:SLOPe POSitive NEGative :TRIGger[:SEquence]:EXTernal2:SLOPe?
Example	TRIG:EXT2:SLOP NEG
Couplings	This same slope is used in the Ext2 selection for the trigger source in the Trigger menu and for the period timer sync source (in the Trigger menu and in the Gate Source menu).
Preset	POSitive
State Saved	Saved in instrument state
Backwards Compatibility SCPI	:TRIGger[:SEquence]:FRAMe:EXTernal2:SLOPe
Backwards Compatibility Notes	The legacy :TRIGger[:SEquence]:SLOPe command affects the slopes for the VID, LINE, EXT1, EXT2, and RFB triggers.
Initial S/W Revision	Prior to A.02.00

RF Burst

Pressing this key, when it is not selected, selects the RF Burst as the trigger. A new sweep/measurement will start when an RF burst envelope signal is identified from the signal at the RF Input connector. Pressing this key, when it is already selected, accesses the RF Burst trigger setup menu.

In some models, a variety of burst trigger circuitry is available, resulting in various available burst trigger bandwidths. The analyzer automatically chooses the appropriate trigger path based on the hardware configuration and other settings of the analyzer.

Key Path	Trigger
Example	TRIG:SOUR RFB Swept SA measurement TRIG:<meas>:SOUR RFB Measurements other than Swept SA
State Saved	Saved in instrument state
Status Bits/OPC dependencies	The Status Operation Register bit 5 "Waiting for Trigger" is set at the same time as the Sweeping or Measuring bit is set. It is cleared when the trigger actually occurs (that is, after the trigger event occurs and all the applicable trigger criteria have been met). A corresponding pop-up message ("Waiting for trigger") is generated if no trigger signal appears after approximately 2 sec. This message goes away when a trigger signal appears.

Backwards Compatibility Notes	The legacy command: :TRIGger[:SEQuence]:RFBurst:FSElectivity[:STATe] OFF ON 0 1 is not supported in the X-Series, as the hardware to do Frequency Selective burst triggers does not exist in X-Series.
Initial S/W Revision	Prior to A.02.00
Modified at S/W Revision	A.04.00

Absolute Trigger Level

Sets the absolute trigger level for the RF burst envelope.

When using the External Mixing path, the Absolute Trigger Level is uncalibrated because the factory default was set to accommodate the expected IF levels for the RF path.

Key Path	Trigger, RF Burst
Scope	Meas Global
Remote Command	:TRIGger[:SEQuence]:RFBurst:LEVel:ABSolute <ampl> :TRIGger[:SEQuence]:RFBurst:LEVel:ABSolute?
Example	TRIG:RFB:LEV:ABS 10 dBm sets the trigger level of the RF burst envelope signal to the absolute level of 10 dBm
Notes	Sending this command does not switch the setting from relative to absolute; to switch it you need to send the :TRIGger[:SEQuence]:RFBurst:LEVel:TYPE command, below. Amplitude Corrections are not taken into account by the Absolute Trigger Level. For example, if you have given yourself effective gain with an amplitude correction factor, the Absolute Trigger will not fire until you have set the trigger level that far below the displayed signal level, rather than simply to the displayed signal level. This is only true for Amplitude Corrections, not External Gain or Ref Level Offset functions. If mode is Bluetooth, the default value is -50 dBm.
Couplings	This same level is used for the RF Burst trigger source in the Trigger menu, for the RF Burst selection in the Periodic Timer sync source (in the Trigger menu and in the Gate Source menu), and also for the RF Burst selection in the Gate Source menu
Preset	-20 dBm
State Saved	Saved in instrument state
Min	-200 dBm
Max	100 dBm
Default Unit	depends on the current selected Y-Axis unit
Backwards Compatibility SCPI	:TRIGger[:SEQuence]:FRAMe:RFBurst:LEVel:ABSolute
Initial S/W Revision	Prior to A.02.00
Modified at S/W Revision	A.04.00

Key Path	Trigger, RF Burst
Remote Command	:TRIGger[:SEquence]:RFBurst:LEVel:TYPE ABSolute RELative :TRIGger[:SEquence]:RFBurst:LEVel:TYPE?
Example	TRIG:RFB:LEV:TYPE REL sets the trigger level type of the RF burst trigger to Relative.
Preset	ABSolute
State Saved	Saved in instrument state
Initial S/W Revision	Prior to A.02.00
Modified at S/W Revision	A.04.00

Trigger Slope

It is set positive to trigger on a rising edge and negative to trigger on a falling edge.

Key Path	Trigger, RF Burst
Remote Command	:TRIGger[:SEquence]:RFBurst:SLOPe POSitive NEGative :TRIGger[:SEquence]:RFBurst:SLOPe?
Example	TRIG:RFB:SLOP NEG
Couplings	This same slope is used in the RF Burst selection for the trigger source in the Trigger menu and for the period timer sync source (in the Trigger menu and in the Gate Source menu).
Preset	POSitive
State Saved	Saved in instrument state
Backwards Compatibility SCPI	:TRIGger[:SEquence]:FRAME:RFBurst:SLOPe
Backwards Compatibility Notes	The legacy :TRIGger[:SEquence]:SLOPe command affects the slopes for the VID, LINE, EXT1, EXT2, and RFB triggers.
Initial S/W Revision	Prior to A.02.00

Trig Delay

This setting delays the measurement timing relative to the Periodic Timer.

Key Path	Trigger, Periodic Timer
Remote Command	:TRIGger[:SEquence]:FRAME:DELAy <time> :TRIGger[:SEquence]:FRAME:DELAy? :TRIGger[:SEquence]:FRAME:DELAy:STATe OFF ON 0 1 :TRIGger[:SEquence]:FRAME:DELAy:STATe?
Notes	Note that delay is used when the sync source is not set to OFF. If the sync source is set to OFF, offset is used.

Preset	Off, 1.000 us
State Saved	Saved in instrument state
Min	-150 ms
Max	+500 ms
Default Unit	s
Initial S/W Revision	Prior to A.02.00

Auto/Holdoff

Opens up a menu that lets you adjust Auto Trigger and Trigger Holdoff parameters

Key Path	Trigger
Readback line	<p>Displays a summary of the Auto Trig and Holdoff settings, in square brackets</p> <p>First line: Auto Off or Auto On</p> <p>Second Line: "Hldf" followed by:</p> <ul style="list-style-type: none"> • If Holdoff is Off, readback Off • If Holdoff On and Type = Normal, readback value • If Holdoff On and Type = Above, readback value followed by AL • If Holdoff On and Type = Below, readback value followed by BL • If Holdoff Type selection is not supported by the current measurement, Holdoff Type is always Normal
Initial S/W Revision	A.02.00

Auto Trig

Sets the time that the analyzer will wait for the trigger conditions to be met. If they are not met after that much time, then the analyzer is triggered anyway.

Key Path	Trigger, Auto/Holdoff
Remote Command	<pre>:TRIGger[:SEquence]:ATRigger <time> :TRIGger[:SEquence]:ATRigger? :TRIGger[:SEquence]:ATRigger:STATe OFF ON 0 1 :TRIGger[:SEquence]:ATRigger:STATe?</pre>
Example	<pre>TRIG:ATR:STAT ON TRIG:ATR 100 ms</pre>
Notes	The "time that the analyzer will wait" starts when the analyzer is ready for a trigger, which may be hundreds of ms after the data acquisition for a sweep is done. The "time" ends when the trigger condition is satisfied, not when the delay ends.
Preset	Off, 100 ms

State Saved	Saved in instrument state
Min	1 ms
Max	100 s
Default Unit	s
Initial S/W Revision	Prior to A.02.00

Trig Holdoff

Sets the holdoff time between triggers. When the trigger condition is satisfied, the trigger occurs, the delay begins, and the holdoff time begins. New trigger conditions will be ignored until the holdoff time expires. For a free-running trigger, the holdoff value is the minimum time between triggers.

Key Path	Trigger, Auto/Holdoff
Remote Command	:TRIGger[:SEquence]:HOLDoff <time> :TRIGger[:SEquence]:HOLDoff? :TRIGger[:SEquence]:HOLDoff:STATe OFF ON 0 1 :TRIGger[:SEquence]:HOLDoff:STATe?
Example	TRIG:HOLD:STAT ON TRIG:HOLD 100 ms
Dependencies	Unavailable if the selected Input is BBIQ. If this is the case, the key is grayed out if it is pressed the informational message "Feature not supported for this Input" is displayed. If the SCPI command is sent, the error "Settings conflict; Feature not supported for this Input" is generated.
Preset	Off, 100 ms
State Saved	Saved in instrument state
Min	0 s
Max	0.5 s
Default Unit	s
Initial S/W Revision	Prior to A.02.00

Holdoff Type

Lets you set the Trigger Holdoff Type.

NOTE

Holdoff Type is not supported by all measurements. If the current measurement does not support it, this key will be blank and the Holdoff Type will be Normal. If the Holdoff Type SCPI is sent while in such a measurement, the SCPI will be accepted and the setting remembered, but it will have no effect until a measurement is in force that supports Holdoff Type.

Trigger Holdoff Type functionality:

- NORMAl

- This is the “oscilloscope” type of trigger holdoff, and is the setting when the Holdoff Type key does not appear. In this type of holdoff, no new trigger will be accepted until the holdoff interval has expired after the previous trigger.
- ABOVE
- If the trigger slope is positive, a trigger event is generated only if the signal characteristic of interest crosses the trigger threshold (with positive slope) and then remains above the threshold for at least the holdoff time. For negative slope, the trigger event is generated if the signal characteristic crosses the threshold (with negative slope) after having been above the threshold for at least the holdoff time. In either case, the trigger event is associated with the time the level was crossed.
- BELOW
- If the trigger slope is positive, a trigger event is generated only if the signal characteristic of interest crosses the trigger threshold (with positive slope) after having been below the threshold for at least the holdoff time. For negative slope, the trigger event is generated if the signal characteristic crosses the threshold (with negative slope) and then remains below the threshold for at least the holdoff time. In either case, the trigger event is associated with the time the level was crossed.

Key Path	Trigger, Auto/Holdoff
Remote Command	:TRIGger[:SEquence]:HOLDoff:TYPE NORMal ABOVe BELow :TRIGger[:SEquence]:HOLDoff:TYPE?
Example	TRIG:HOLD:TYPE NORM
Preset	All modes but GSM/EDGE: Normal GSM/EDGE: Below WLAN: Below
State Saved	Saved in instrument state
Initial S/W Revision	A.02.00

8 Complex Spectrum Measurement

The complex spectrum measurement provides spectrum analysis capability for the instrument. The control of the measurement was designed to be familiar to those who are accustomed to using swept spectrum analyzers. For more details about this measurement, see the section "[Complex Spectrum Measurement Description](#)" on page 259 below.

This topic contains the following sections:

["Measurement Commands for Complex Spectrum"](#) on page 256

["Remote Command Results for Complex Spectrum"](#) on page 257

Measurement Commands for Complex Spectrum

The general functionality of CONFigure, INITiate, FETCh, MEASure, and READ are described in the section ["Remote Measurement Functions" on page 557](#). See the SENSE subsystem commands for more measurement related commands.

:CONFigure:SPECTrum

:CONFigure:SPECTrum:NDEFault

:INITiate:SPECTrum

:FETCh:SPECTrum[n]?

:MEASure:SPECTrum[n]?

:READ:SPECTrum[n]?

Remote Command Results for Complex Spectrum

The following table shows the returned results of the FETCh|MEASure|READ queries.

n	Results Returned
0	Returns unprocessed I/Q trace data, as a series of trace point values, in volts. The I values are listed first in each pair, using the 0 through even-indexed values. The Q values are the odd-indexed values.
not specified or n=1	Returns the following comma-separated scalar results: <ol style="list-style-type: none"> 1. FFT peak is the FFT peak amplitude. 2. FFT frequency is the FFT frequency of the peak amplitude. 3. FFT points is the Number of points in the FFT spectrum. 4. First FFT frequency is the frequency of the first FFT point of the spectrum. 5. FFT spacing is the frequency spacing between the FFT points of the spectrum. 6. Time domain points is the number of points in the time domain trace used for the FFT. The number of points doubles if the data is complex instead of real. See the time domain scalar description below. 7. First time point is the time of the first time domain point, where time zero is the trigger event. 8. Time spacing is the time spacing between the time domain points. The time spacing value doubles if the data is complex instead of real. See the time domain scaler description below. 9. Time domain returns a 1 if time domain is complex (I/Q) and complex data will be returned. It returns a 0 if the data is real. (raw ADC samples) When this value is 1 rather than 0 (complex vs. real data), the time domain points and the time spacing scalars both increase by a factor of two. 10. Scan time is the total scan time of the time domain trace used for the FFT. The total scan time = (time spacing) x (time domain points – 1) 11. Current average count is the current number of data measurements that have already been combined, in the averaging calculation.
2	Returns the trace data of the log-magnitude versus time. (That is, the RF envelope.)
3	Returns the I and Q trace data. It is represented by I and Q pairs (in volts) versus time.
4	Returns spectrum trace data. That is, the trace of log-magnitude versus frequency. (The trace is computed using a FFT.)
5	Returns the averaged trace data of log-magnitude versus time. (That is, the RF envelope.)
6	Not used.
7	Returns the averaged spectrum trace data. That is, the trace of the averaged log-magnitude versus frequency.
8	Not used.
9	Returns a trace containing the shape of the FFT window.
10	Returns trace data of the phase of the FFT versus frequency.
11	Returns comma-separated linear spectrum trace data in Volts RMS.
12	Returns comma-separated averaged linear spectrum trace data in Volts RMS.
13	Returns the following comma-separated scalar results: <ol style="list-style-type: none"> 1. I/Q Magnitude and Phase Delta Results available (0 = not available, 1 = available). Results are available when the last measurement was made with I/Q Magnitude and Phase Delta Results enabled (SPEC:IQD:ENAB ON) and the setup was valid for generating the results (invalid setup when input is I/Q, I/Q Path is I+jQ, and Center Frequency is not 0 Hz)

n	Results Returned
	2. Delta magnitude and phase trace (results 14 – 17) start frequency (0 when I/Q Magnitude and Phase Delta Results not available)
	3. Delta magnitude and phase trace (results 14 – 17) number of points (1 when I/Q Magnitude and Phase Delta Results not available)
	4. Delta magnitude and phase trace (results 14 – 17) frequency spacing between points (0 when I/Q Magnitude and Phase Delta Results not available)
	5. Current average count (1 when I/Q Magnitude and Phase Delta Results not available)
	6. Frequency of the FFT trace (result 4) peak magnitude in Hz (0 when I/Q Magnitude and Phase Delta Results not available)
	7. Delta magnitude at the FFT trace peak magnitude frequency in dB (-999 when I/Q Magnitude and Phase Delta Results not available)
	8. Delta phase at the FFT trace peak magnitude frequency in radians (-999 when I/Q Magnitude and Phase Delta Results not available)
	9. Delta phase at the FFT trace peak magnitude frequency in degrees (-999 when I/Q Magnitude and Phase Delta Results not available or invalid setup)
	10. Frequency of the averaged FFT trace (result 7) peak magnitude in Hz (0 when I/Q Magnitude and Phase Delta Results not available)
	11. Averaged delta magnitude at the averaged FFT trace peak magnitude frequency in dB (-999 when I/Q Magnitude and Phase Delta Results not available)
	12. Averaged delta phase at the averaged FFT trace peak magnitude frequency in radians (-999 when I/Q Magnitude and Phase Delta Results not available)
	13. Averaged delta phase at the averaged FFT trace peak magnitude frequency in degrees (-999 when I/Q Magnitude and Phase Delta Results not available)
14	Current delta magnitude trace in dB (-999 when I/Q Magnitude and Phase Delta Results not available)
15	Current delta phase trace in radians (-999 when I/Q Magnitude and Phase Delta Results not available)
16	Averaged delta magnitude trace in dB (-999 when I/Q Magnitude and Phase Delta Results not available)
17	Averaged delta phase trace in radians (-999 when I/Q Magnitude and Phase Delta Results not available)

Complex Spectrum Measurement Description

This measurement is FFT (Fast Fourier Transform) based. The FFT-specific parameters are located in the advanced menu. Also available under basic mode spectrum measurements is an I/Q window, which shows the I and Q signal waveforms in parameters of voltage versus time. The advantage of having an I/Q view available while in the spectrum measurement is that it allows you to view complex components of the same signal without changing settings or measurements.

Key Path	Front-panel key
Initial S/W Revision	Prior to A.02.00

AMPTD Y Scale

Accesses the vertical scale parameters menu. The menu selection is dependent on the active window view.

Key Path	Front-panel key
Initial S/W Revision	Prior to A.02.00

Ref Value (Spectrum window)

Enables you to adjust the absolute power reference value in the spectrum view window. Ref in the upper left corner of the display, indicates the current value. To change the reference level, use the front-panel step keys, knob, or numeric keypad.

Key Path	AMPTD Y Scale
Mode	BASIC
Remote Command	:DISPlay:SPECTrum:VIEW[1]:WINDow[1]:TRACe:Y[:SCALe]:RLEVel <ampl> :DISPlay:SPECTrum:VIEW[1]:WINDow[1]:TRACe:Y[:SCALe]:RLEVel?
Example	DISP:SPEC:VIEW:WIND:TRAC:Y:RLEV 100 DISP:SPEC:VIEW:WIND:TRAC:Y:RLEV?
Notes	You must be in the IQ Analyzer (Basic) mode to use this command. Use INSTRument:SElect to set the mode.
Couplings	When Auto Scaling is turned on, this value is automatically determined by the measurement result. When this value is set, Auto Scaling is turned off. Attenuation is not coupled to Ref Value.
Preset	0.00 dBm
State Saved	Saved in instrument state.
Min	-250 dBm
Max	250 dBm
Initial S/W Revision	Prior to A.02.00

Range

Represents the amplitude of the largest sinusoidal signal that could be present within the IF without being clipped by the ADC. For signals with high peak-to-average ratios, the range may need to exceed the rms signal power by a fair amount to avoid clipping.

Key Path	Range
Mode	BASIC
Remote Command	[:SENSe]:POWer[:RF]:RANGe <real> [:SENSe]:POWer[:RF]:RANGe?

Example	:POW:RANG 10.0 :POW:RANG?
Notes	The MIN and MAX values are affected by the External Gain parameters, and by the Center Frequency. (The hardware compensates for frequency response and alters the Range setting.)
Preset	0
State Saved	Saved in instrument state.
Min	-100
Max	100
Initial S/W Revision	A.12.50

Peak to Average

The Peak to Average Ratio is used with the Range setting to optimize the level control in the instrument. The value is the ratio, in dB, of the peak power to the average power of the signal to be measured. A ratio of 0 should be used for sinusoidal signals; for 802.11g OFDM signals use 9 dB.

All Applications (Modes) will show the current value of Peak to Average ratio on the softkey. However, some applications will not permit changing the value. In these situations the softkey will be grayed-out.

Key Path	AMPTD Y Scale, Range
Remote Command	[:SENSe] :POWer [:RF] :RANGe :PARatio <real> [:SENSe] :POWer [:RF] :RANGe :PARatio?
Example	POW:RANG:PAR 12 dB
Notes	In some Applications (Modes) this parameter will be read-only; meaning the value will appear on the softkey and query via SCPI, but not changeable. In such applications the softkey will be grayed-out. Attempting to change the value via SCPI will be ignored and no error message will be generated.
Preset	10 dB
State Saved	Saved in instrument state
Min	0 dB
Max	20 dB
Initial S/W Revision	A.13.00

Mixer Level Offset

Mixer level offset is an advanced setting to adjust target Range at the input mixer which in turn affects the signal level in the instrument's IF. This setting can be used when additional optimization is needed after setting Peak to Average ratio. Positive values of offset optimize noise performance over distortion, negative values optimize distortion performance over noise.

Key Path	AMPTD Y Scale, Range
Remote Command	[:SENSe] :POWer [:RF] :RANGe :MIXer :OFFSet <real>

	<code>[:SENSe] :POWeR [:RF] :RANGe :MIXer :OFFSet ?</code>
Example	<code>POW:RANG:MIX:OFFS -5 dB</code>
Preset	0 dB
State Saved	Saved in instrument state
Min	-35 dB
Max	30 dB
Initial S/W Revision	A.13.00

Scale/Div (Spectrum)

Sets the vertical scale in spectrum view by changing the amplitude value per division.

Key Path	AMPTD Y Scale
Mode	BASIC
Remote Command	<code>:DISPlay:SPECTrum:VIEW[1]:WINDow[1]:TRACe:Y[:SCALe]:PDIVision <rel_ ampl></code> <code>:DISPlay:SPECTrum:VIEW[1]:WINDow[1]:TRACe:Y[:SCALe]:PDIVision?</code>
Example	<code>DISP:SPEC:VIEW:WIND:TRAC:Y:PDIV 10</code> <code>DISP:SPEC:VIEW:WIND:TRAC:Y:PDIV?</code>
Notes	You must be in the IQ Analyzer (Basic) mode to use this command. Use <code>INSTRument:SElect</code> to set the mode.
Couplings	When you set a value manually, Auto Scaling automatically changes to Off. When Auto Scaling is turned on, this value is automatically determined by the measurement result.
Preset	10 dB
State Saved	Saved in instrument state.
Min	0.10 dB
Max	20 dB
Initial S/W Revision	Prior to A.02.00

Ref Position (Spectrum)

Allows you to set the spectrum reference position to Top, Ctr (center) or Bottom.

Key Path	AMPTD Y Scale
Mode	BASIC
Remote Command	<code>:DISPlay:SPECTrum:VIEW[1]:WINDow[1]:TRACe:Y[:SCALe]:RPOSition TOP CENTER BOTTom</code> <code>:DISPlay:SPECTrum:VIEW[1]:WINDow[1]:TRACe:Y[:SCALe]:RPOSition?</code>
Example	<code>DISP:SPEC:VIEW:WIND2:TRAC:Y:RPOS CENT</code>

	DISP:SPEC:VIEW:WIND2:TRAC:Y:RPOS?
Notes	You must be in the IQ Analyzer (Basic) mode to use this command. Use INSTRUMENT:SElect to set the mode.
Preset	TOP
State Saved	Saved in instrument state.
Range	Top Ctr Bot
Initial S/W Revision	Prior to A.02.00

Auto Scaling

Enables you to toggle the Auto Scaling function between On and Off. Upon pressing the Restart front-panel key or the Restart key under the Meas Control menu, the Auto Scaling function automatically determines the scale per division and reference values based on the measurement results.

Key Path	AMPTD Y Scale
Mode	BASIC
Remote Command	:DISPlay:SPECTrum:VIEW[1]:WINDow[1] 2:TRACe:Y[:SCALe]:COUPle ON OFF 1 0 :DISPlay:SPECTrum:VIEW[1]:WINDow[1] 2:TRACe:Y[:SCALe]:COUPle?
Example	DISP:SPEC:VIEW:WIND2:TRAC:Y:COUP 0
Notes	You must be in the IQ Analyzer (Basic) mode to use this command. Use INSTRUMENT:SElect to set the mode.
Couplings	When you set a value to either Scale/Div or Ref Value manually, Auto Scaling automatically changes to Off. When this value is turned on, Ref Value and Scale/Div are automatically determined by the measurement result.
Preset	OFF
State Saved	Saved in instrument state.
Range	On Off
Initial S/W Revision	Prior to A.02.00

Auto Couple

The Auto Couple feature provides a quick and convenient way to automatically couple multiple instrument settings. This helps ensure accurate measurements and optimum dynamic range. When the Auto Couple feature is activated, either from the front panel or remotely, all parameters of the current measurement that have an Auto/Manual mode are set to Auto mode and all measurement settings dependent on (or coupled to) the Auto/Man parameters are automatically adjusted for optimal performance.

However, the Auto Couple key actions are confined to the current measurement only. It does not affect other measurements in the mode, and it does not affect markers, marker functions, or trace or display attributes.

See ["More Information" on page 264](#)

Key Path	Front-panel key
Remote Command	:COUPLe ALL NONE
Example	:COUP ALL
Notes	:COUPLe ALL puts all Auto/Man parameters in Auto mode (equivalent to pressing the Auto Couple key). :COUPLE NONE puts all Auto/Man parameters in manual mode. It decouples all the coupled instrument parameters and is not recommended for making measurements.
Initial S/W Revision	Prior to A.02.00

More Information

There are two types of functions that have Auto/Manual modes.

Auto/Man Active Function keys

An Auto/Man toggle key controls the binary state associated with an instrument parameter by toggling between **Auto** (where the parameter is automatically coupled to the other parameters it is dependent upon) and **Man** (where the parameter is controlled independent of the other parameters), as well as making the parameter the active function. The current mode is indicated on the softkey with either **Auto** or **Man** underlined as illustrated below.

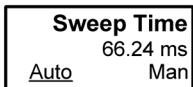

vsd07

Auto/Man 1-of-N keys

An Auto/Man 1-of-N key allows you to manually pick from a list of parameter values, or place the function in Auto, in which case the value is automatically selected (and indicated) as shown below. If in Auto, Auto is underlined on the calling key. If in manual operation, manual is indicated on the calling key. But the calling key does not actually toggle the function, it simply opens the menu.

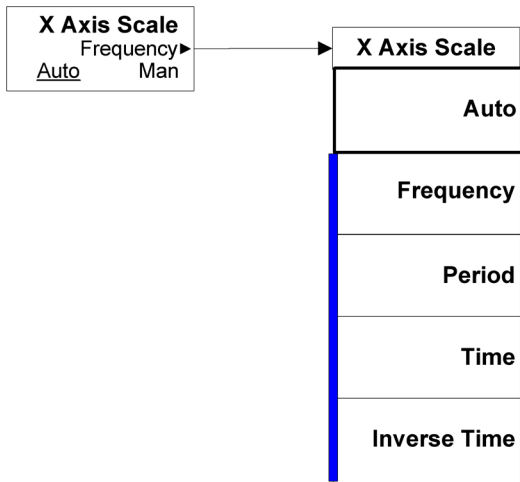

vsd08

BW

Opens the Bandwidth menu.

Key Path	Front-panel key
Initial S/W Revision	Prior to A.02.00

Res BW

Enables you to set the resolution bandwidth setting. This is the resolution bandwidth of the FFT analysis. Changing this value changes the FFT Window size, FFT length and the sweep time (measurement capture length).

If FFT Length Ctrl in the FFT Size menu under Meas Setup, Advanced is set to Manual, the Res BW key is grayed out and shows the resolution bandwidth determined by the FFT Window size.

If the function is auto-coupled, the value setting is ignored.

Key Path	BW
Mode	BASIC
Remote Command	[:SENSe]:SPECTrum:BANDwidth[:RESolution] <bandwidth> [:SENSe]:SPECTrum:BANDwidth[:RESolution]? [:SENSe]:SPECTrum:BANDwidth[:RESolution]:AUTO ON OFF 1 0 [:SENSe]:SPECTrum:BANDwidth[:RESolution]:AUTO?
Example	SPEC:BAND 100 SPEC:BAND? SPEC:BAND:AUTO OFF SPEC:BAND:AUTO?
Notes	You must be in the IQ Analyzer (Basic) mode to use this command. Use INSTRument:SElect to set the mode.
Preset	160 kHz ON
State Saved	Saved in instrument state.
Min	0.1 Hz
Max	3.0 MHz
Backwards Compatibility SCPI	[:SENSe]:SPECTrum:BWIDth[:RESolution]
Initial S/W Revision	Prior to A.02.00

Cont (Continuous Measurement/Sweep)

Sets the analyzer for Continuous measurement operation. The single/continuous state is Meas Global so the setting will affect all measurements. If you are Paused, pressing **Cont** does a Resume.

Key Path	Front-panel key
Remote Command	:INITiate:CONTinuous OFF ON 0 1 :INITiate:CONTinuous?
Example	:INIT:CONT 0 puts analyzer in Single measurement operation. :INIT:CONT 1 puts analyzer in Continuous measurement operation
Preset	ON (Note that SYST:PRESet sets INIT:CONT to ON but *RST sets INIT:CONT to OFF)
State Saved	Saved in instrument state
Backwards Compatibility Notes	For Spectrum Analysis mode in ESA and PSA, there is no Cont hardkey, instead there is a Sweep Single/Cont key. In these analyzers, switching the Sweep Single/Cont key from Single to Cont restarts averages (displayed average count reset to 1), but does not restart Max Hold and Min Hold . The X-Series has Single and Cont keys in place of the SweepSingleCont key. In the X-Series, if in single measurement, the Cont key (and INIT:CONT ON) switches to continuous measurement, but never restarts a measurement and never resets a sweep.
Initial S/W Revision	Prior to A.02.00

In Swept SA Measurement (Spectrum Analysis Mode):

The analyzer takes repetitive sweeps, averages, measurements, etc., when in Continuous mode. When the average count reaches the Average/Hold Number the count stops incrementing, but the analyzer keeps sweeping. See the Trace/Detector section for the averaging formula used both before and after the Average/Hold Number is reached. The trigger condition must be met prior to each sweep. The type of trace processing for multiple sweeps, is set under the Trace/Detector key, with choices of **Trace Average**, **Max Hold**, or **Min Hold**.

In Other Measurements/Modes:

With **Avg/Hold Num** (in the **Meas Setup** menu) set to **Off** or set to **On** with a value of 1, a sweep is taken after the trigger condition is met; and the analyzer continues to take new sweeps after the current sweep has completed and the trigger condition is again met. However, with **Avg/Hold Num** set to On with a value >1, multiple sweeps (data acquisitions) are taken for the measurement. The trigger condition must be met prior to each sweep. The sweep is not stopped when the average count k equals the number N set for Avg/Hold Num is reached, but the number k stops incrementing. A measurement average usually applies to all traces, marker results, and numeric results. But sometimes it only applies to the numeric results.

If the analyzer is in Single measurement, pressing the **Cont** key does not change k and does not cause the sweep to be reset; the only action is to put the analyzer into Continuous measurement operation.

If it is already in continuous sweep:

the INIT:CONT 1 command has no effect

8 Complex Spectrum Measurement Cont (Continuous Measurement/Sweep)

the INIT:CONT 0 command will place the analyzer in Single Sweep but will have no effect on the current sequence until $k = N$, at which point the current sequence will stop and the instrument will go to the idle state.

File

See "File" on page 160

Frequency/Channel

Opens a menu that enables you to control the Center Frequency of the instrument.

Key Path	Front-panel key
Initial S/W Revision	Prior to A.02.00

Center Freq

Sets the frequency that corresponds to the horizontal center of the graticule (when frequency Scale Type is set to linear). While adjusting the Center Frequency the Span is held constant, which means that both Start Frequency and Stop Frequency will change.

Pressing Center Freq also sets the frequency entry mode to Center/Span. In Center/Span mode, the center frequency and span values are displayed below the graticule, and the default active function in the Frequency menu is **Center Freq**.

The center frequency setting is the same for all measurements within a mode, that is, it is Meas Global. Some modes are also able to share a Mode Global center frequency value. If this is the case, the Mode will have a **Global Settings** key in its **Mode Setup** menu.

The **Center Freq** function sets (and queries) the Center Frequency for the currently selected input. If your analyzer has multiple inputs, and you select another input, the Center Freq changes to the value for that input. SCPI commands are available to directly set the Center Freq for a specific input.

Center Freq is remembered as you go from input to input. Thus you can set a Center Freq of 10 GHz with the RF Input selected, change to BBIQ and set a Center Freq of 20 MHz, then switch to External Mixing and set a Center Freq of 60 GHz, and when you go back to the RF Input the Center Freq will go back to 10 GHz; back to BBIQ and it is 20 MHz; back to External Mixing and it is 60 GHz.

See ["RF Center Freq" on page 273](#)

See [Ext Mix Center Freq](#)

See ["I/Q Center Freq" on page 275](#)

See ["Center Frequency Presets" on page 271](#)

Key Path	FREQ Channel
Scope	Meas Global
Remote Command	<code>[:SENSe] :FREQuency:CENTer <freq></code> <code>[:SENSe] :FREQuency:CENTer?</code>
Example	FREQ:CENT 50 MHz FREQ:CENT UP changes the center frequency to 150 MHz if you use FREQ:CENT:STEP 100 MHz to set the center frequency step size to 100 MHz FREQ:CENT?
Notes	This command sets either the RF or I/Q Center Frequency depending on the selected input. For RF input it is equivalent to FREQ:RF:CENT

	<p>For I/Q input it is equivalent to <code>FREQ:IQ:CENT</code></p> <p>Preset and Max values are dependent on Hardware Options (5xx)</p> <p>If no terminator (e.g. MHz) is sent the terminator Hz is used. If a terminator with unit other than Frequency is used, an invalid suffix error message is generated.</p>
Dependencies	The Center Frequency can be limited by Start or Stop Freq limits, if the Span is so large that Start or Stop reach their limit.
Couplings	When operating in "swept span", any value of the Center Frequency or Span that is within the frequency range of the analyzer is allowed when the value is being set through the front panel numeric key pad or the SCPI command. The other parameter is forced to a different value if needed, to keep the Start and the Stop Frequencies within the analyzer's frequency range
Preset	<p>Depends on instrument maximum frequency, mode, measurement, and selected input.</p> <p>See "Center Frequency Presets" on page 271 and "RF Center Freq" on page 273 and Ext Mix Center Freq and "I/Q Center Freq" on page 275.</p>
State Saved	Saved in instrument state
Min	<p>Depends on instrument maximum frequency, mode, measurement, and selected input..</p> <p>See "Center Frequency Presets" on page 271 and "RF Center Freq" on page 273 and "I/Q Center Freq" on page 275.</p>
Max	<p>Depends on instrument maximum frequency, mode, measurement, and selected input..</p> <p>See "Center Frequency Presets" on page 271 and "RF Center Freq" on page 273 and "I/Q Center Freq" on page 275.</p>
Default Unit	Hz
Status Bits/OPC Dependencies	Non-overlapped
Initial S/W Revision	Prior to A.02.00

Center Frequency Presets

The following table provides the Center Frequency Presets for the Spectrum Analyzer mode, and the Max Freq, for the various frequency options:

Freq Option	CF after Mode Preset	Stop Freq after Mode Preset	Max Freq (can't tune above)
503 (all but N9000A)	1.805 GHz	3.6 GHz	3.7 GHz
503 (N9000A)	1.505 GHz	3.0 GHz	3.08 GHz
507	3.505 GHz	7.0 GHz	7.1 GHz

8 Complex Spectrum Measurement
Frequency/Channel

(all but N9000A)			
507	3.755 GHz	7.5 GHz	7.58 GHz
(N9000A)			
508	1.805 GHz	3.6 GHz	8.5 GHz
(all but N9038A)			
508	4.205 GHz	8.4 GHz	8.5 GHz
(N9038A)			
513	6.805 GHz	13.6 GHz	13.8 GHz
526	13.255 GHz	26.5 GHz	27.0 GHz
(all but N9000A and N9038A)			
526	13.255 GHz	26.5 GHz	26.55 GHz
(N9000A)			
526	1.805 GHz	3.6 GHz	27.0 GHz
(N9038A)			
532	16.005 GHz	32.0 GHz	32.5 GHz
543	21.505 GHz	43.0 GHz	TBD
544	22.005 GHz	44.0 GHz	44.5 GHz
550	25.005 GHz	50.0 GHz	51 GHz

Input 2:

Model	CF after Mode Preset	Stop Freq after Mode Preset	Max Freq (can't tune above)
N9000A opt C75	0.7505GHz	1.5 GHz	1.58 GHz
N9038A	505 MHz	1 GHz	1.000025 GHz

Tracking Generator Frequency Limits (N9000A only):

Tracking Generator Option	Min Freq (clips to this freq when turn TG on and can't tune below while TG on)	If above this Freq, Stop Freq clipped to this Freq when TG turned on	Max Freq (can't tune above) while TG on
T03	9 kHz	3.0 GHz	3.08 GHz
T06	9 kHz	6.0 GHz	6.05 GHz

The following table shows the Center Frequency Presets for modes other than Spectrum Analyzer:

Mode	CF Preset for RF
WCDMA	1 GHz
WIMAXOFDMA,	1 GHz
BASIC	1 GHz
ADEMOD	1 GHz
VSA	1 GHz
TDSCDMA	1 GHz
PNOISE	1 GHz
LTE	1 GHz
LTETDD	1 GHz
MSR	1 GHz
GSM	935.2 MHz
NFIGURE	1.505 GHz

RF Center Freq

SCPI command for specifying the RF Center Frequency. This command will set the Center Frequency to be used when the RF input is selected, even if the RF input is not the input that is selected at the time the command is sent. Note that the **Center Freq** function in the **Frequency** menu on the front panel always applies to the currently selected input.

Scope	Meas Global
Remote Command	<code>[:SENSe] :FREQuency:RF:CENTer <freq></code> <code>[:SENSe] :FREQuency:RF:CENTer?</code>
Example	FREQ:RF:CENT 30 MHz
Notes	This command is the same in all modes, but the parameter is Measurement Global. So the value is independent in each mode and common across all the measurements in the mode.
Dependencies	If the electronic/soft attenuator is enabled, any attempt to set Center Frequency such that the Stop Frequency would be >3.6 GHz fails and results in an advisory message. If the equivalent SCPI command is sent, this same message is generated as part of a “-221, Settings conflict” warning. If Source Mode is set to Tracking, and the Max or Min Center Freq is therefore limited by the limits of the source, a warning message is generated, “Data out of range;clipped to source max/min” if these limits are exceeded. Note that for an external source, these limits can be affected by the settings of Source Numerator, Source Denominator and Power Sweep.
Preset	See table above
State Saved	Saved in instrument state.
Min	-79.999995 MHz, unless Source Mode is set to Tracking, in which case it is limited by the minimum frequency of the Source
Max	See table above. Basically instrument maximum frequency - 5 Hz. Note that, if the Source Mode is set to Tracking, the effective instrument maximum frequency may be limited by the source maximum frequency.

	If the knob or step keys are being used, also depends on the value of the other three interdependent parameters Span, Start Frequency and Stop Frequency
Initial S/W Revision	Prior to A.02.00
Modified at S/W Revision	A.03.00

Ext Mix Center Freq

SCPI command for specifying the External Mixer Center Frequency. This command will set the Center Frequency to be used when the External Mixer is selected, even if the External Mixer input is not the input which is selected at the time the command is sent. Note that the **Center Freq** function in the **Frequency** menu on the front panel always applies to the currently selected input.

Scope	Meas Global
Remote Command	<code>[:SENSe] :FREQuency:EMIXer:CENTer <freq></code> <code>[:SENSe] :FREQuency:EMIXer:CENTer?</code>
Example	<code>:FREQ:EMIX:CEN 60 GHz</code> <code>:FREQ:EMIX:CEN?</code>
Notes	This command is the same in all modes, but the parameter is Measurement Global. So the value is independent in each mode and common across all the measurements in the mode.
Couplings	When returning to External Mixing after having been switched to one of the other inputs (e.g., RF), you will come back into the settings that you had when you left External Mixing. So you will come back to the band you were in with the Center Frequency that you had. However, Span is not an input-dependent parameter, therefore you will bring the span over from the other input. Therefore, the analyzer comes back with the span from the previous input, limited as necessary by the current mixer setup.
Preset	When a Mode Preset is performed while in External Mixing, the Start frequency of the current Mode is set to the nominal Min Freq of the lowest harmonic range in the Harmonic Table for the current mixer setup. Similarly, the Stop frequency of the current Mode is set to the nominal Max Freq of the highest harmonic range in the Harmonic Table. The Center Freq thus presets to the point arithmetically equidistant from these two frequencies. If the current measurement has a limited Span available to it, and cannot achieve the Span shown in the table (Span=Stop Freq – Start Freq), the analyzer uses the maximum Span the measurement allows, and still sets the Center Freq to the midpoint of the Start and Stop Freq values in the Harmonic Table. When Restore Input/Output Defaults is performed, the mixer presets to the 11970A, whose Start and Stop frequencies are 26.5 and 40 GHz respectively. The center of these two frequencies is 33.25 GHz. Therefore, after a Restore Input/Output Defaults, if you go into External Mixing and do a Mode Preset while in the Spectrum Analyzer Mode, the resulting Center Freq is 33.25 GHz.
State Saved	Saved in instrument state.
Min	The minimum frequency in the currently selected mixer band + 5 Hz
Max	The maximum frequency in the currently selected mixer band – 5 Hz

If the knob or step keys are being used, also depends on the value of the other three interdependent parameters Span, Start Frequency and Stop Frequency

Initial S/W Revision A.08.01

I/Q Center Freq

SCPI command for specifying the I/Q Center Frequency. This command will set the Center Frequency to be used when the I/Q input is selected, even if the I/Q input is not the input which is selected at the time the command is sent. Note that the **Center Freq** function in the **Frequency** menu on the front panel always applies to the currently selected input.

Scope	Meas Global
Remote Command	[:SENSe] :FREQuency:IQ:CENTer <freq> [:SENSe] :FREQuency:IQ:CENTer?
Example	FREQ:IQ:CENT: 30 MHz
Notes	This command is the same in all modes, but the parameter is Measurement Global. So the value is independent in each mode and common across all the measurements in the mode.
Preset	0 Hz
State Saved	Saved in instrument state.
Min	-40.049995 MHz
Max	40.049995 MHz
Initial S/W Revision	Prior to A.02.00

Input/Output

See ["Input/Output" on page 102](#)

Marker

Accesses a menu that enables you to set the marker parameters.

Key Path	Front-panel key
Initial S/W Revision	Prior to A.02.00

Select Marker

Displays 12 markers available for selection.

Key Path	Marker
Initial S/W Revision	Prior to A.02.00

Marker Type

Sets the marker control mode as described under **Normal**, **Delta** and **Off**. All interactions and dependencies detailed under the key description are enforced when the remote command is sent.

Key Path	Marker
Mode	BASIC
Remote Command	:CALCulate:SPECTrum:MARKer[1] 2 ... 12:MODE POSition DELTa OFF :CALCulate:SPECTrum:MARKer[1] 2 ... 12:MODE?
Example	CALC:SPEC:MARK:MODE OFF CALC:SPEC:MARK:MODE?
Notes	If the selected marker is Off, pressing Marker sets it to Normal and places it at the center of the screen on the trace determined by the Marker Trace rules. At the same time, Marker X Axis Value appears on the Active Function area. Default Active Function: the active function for the selected marker's current control mode. If the current control mode is Off, there is no active function and the active function is turned off. Active Function Display: the marker X axis value entered in the active function area displays the marker value to its full entered precision. You must be in the IQ Analyzer (Basic) mode to use this command. Use INSTRument:SElect to set the mode.
Preset	OFF
State Saved	Saved in instrument state.
Range	Normal Delta Off
Initial S/W Revision	Prior to A.02.00

Properties

Accesses a menu used to set certain properties of the selected marker.

Key Path	Marker
Initial S/W Revision	Prior to A.02.00

Select Marker

Displays 12 markers available for selection.

Key Path	Marker
Initial S/W Revision	Prior to A.02.00

Relative To

Selects the marker relative to its reference marker.

Key Path	Marker, Properties
Mode	BASIC
Remote Command	:CALCulate:SPECTrum:MARKer[1] 2 ... 12:REFerence <integer> :CALCulate:SPECTrum:MARKer[1] 2 ... 12:REFerence?
Example	CALC:SPEC:MARK6:REF 8 CALC:SPEC:MARK:REF?
Notes	A marker cannot be relative to itself so that choice is grayed out, and if sent from SCPI generates error -221: "Settings conflict; marker cannot be relative to itself." When queried a single value is returned (the specified marker numbers relative marker).
Preset	2 3 4 5 6 7 8 9 10 11 12 1
State Saved	Saved in instrument state.
Min	1
Max	12
Initial S/W Revision	Prior to A.02.00

Marker Trace

Assigns the specified marker to the designated trace.

Key Path	Marker
Mode	BASIC
Remote Command	:CALCulate:SPECTrum:MARKer[1] 2 ... 12:TRACe SPECTrum ASPECTrum I Q IQ :CALCulate:SPECTrum:MARKer[1] 2 ... 12:TRACe?
Example	CALC:SPEC:MARK:TRAC SPEC

	CALC:SPEC:MARK:TRAC?
Notes	Assigns the specified marker to the designated trace. The IQ selection is for backward compatibility purposes. It is recommended that the users use the I and/or Q selection instead. You must be in a mode that includes the Complex Spectrum measurement to use this command. Use INSTRUMENT:SElect to set the mode.
Preset	SPECTrum
State Saved	Saved in instrument state.
Range	Spectrum Spectrum Avg IQ Q
Initial S/W Revision	Prior to A.02.00

Couple Markers

When this function is true, moving any marker causes an equal X Axis movement of every other marker that is not **Off**. By “equal X Axis movement” we mean that we preserve the difference between each marker’s X Axis value (in the fundamental x-axis units of the trace that marker is on) and the X Axis value of the marker being moved (in the same fundamental x-axis units).

Key Path	Marker
Mode	BASIC
Remote Command	:CALCulate:SPECTrum:MARKer:COUPle[:STATe] ON OFF 1 0 :CALCulate:SPECTrum:MARKer:COUPle[:STATe]?
Example	CALC:SPEC:MARK:COUP ON CALC:SPEC:MARK:COUP?
Notes	You must be in the IQ Analyzer (Basic) mode to use this command. Use INSTRUMENT:SElect to set the mode.
Preset	OFF
State Saved	Saved in instrument state.
Range	On Off
Initial S/W Revision	Prior to A.02.00

All Markers Off

Turns off all markers.

Key Path	Marker
Mode	BASIC
Remote Command	:CALCulate:SPECTrum:MARKer:AOff
Example	CALC:SPEC:MARK:AOff
Notes	You must be in the IQ Analyzer (Basic) mode to use this command. Use INSTRUMENT:SElect to set the

	mode.
Initial S/W Revision	Prior to A.02.00

Marker X Axis Value (Remote Command Only)

Sets the marker X Axis value in the current marker X Axis Scale unit. It has no effect if the control mode is **Off**, but is the SCPI equivalent of entering an X value if the control mode is **Normal** or **Delta**.

Mode	BASIC
Remote Command	:CALCulate:SPECTrum:MARKer[1] 2 ... 12:X <freq> :CALCulate:SPECTrum:MARKer[1] 2 ... 12:X?
Example	CALC:SPEC:MARK3:X 100 CALC:SPEC:MARK3:X?
Notes	If no suffix is sent it uses the fundamental units for the current marker X Axis Scale. If a suffix is sent that does not match the current marker X Axis Scale unit, an error "Invalid suffix" is generated. The query returns the marker's absolute X Axis value if the control mode is Normal , or the offset from the marker's reference marker if the control mode is Delta . The query is returned in the fundamental units for the current marker X Axis scale: Hz for Frequency and Inverse Time , seconds for Period and Time . If the marker is Off the response is not a number. You must be in the IQ Analyzer (Basic) mode to use this command. Use INSTRument:SElect to set the mode.
Preset	After a preset, all markers are turned OFF, so Marker X Axis Value query returns a not a number (NAN).
State Saved	No
Range	Depends on X axis range of selected Trace.
Min	-9.9E+37
Max	9.9E+37
Initial S/W Revision	Prior to A.02.00

Marker X Axis Position (Remote Command Only)

Sets the marker X position in trace points. It has no effect if the control mode is **Off**, but is the SCPI equivalent of entering a value if the control mode is **Normal** or **Delta** - except in trace points rather than X Axis Scale units. The entered value is immediately translated into the current X Axis Scale units for setting the value of the marker.

Mode	BASIC
Remote Command	:CALCulate:SPECTrum:MARKer[1] 2 ... 12:X:POSition <freq> :CALCulate:SPECTrum:MARKer[1] 2 ... 12:X:POSition?
Example	CALC:SPEC:MARK10:X:POS 500 CALC:SPEC:MARK10:X:POS?

Notes	The query returns the marker's absolute X Axis value in trace points if the control mode is Normal , or the offset from the marker's reference marker in trace points if the control mode is Delta . The value is returned as a real number, not an integer, corresponding to the translation from X Axis Scale units to trace points. If the marker is Off the response is not a number. You must be in the IQ Analyzer (Basic) mode to use this command. Use INSTRUMENT:SElect to set the mode.
Preset	After a preset, all markers are turned OFF, so Marker X Axis Value query returns a not a number (NAN).
State Saved	No
Range	Depends on length of selected Trace.
Min	-9.9E+37 (Depends on length of selected Trace.)
Max	9.9E+37 (Depends on length of selected Trace.)
Initial S/W Revision	Prior to A.02.00

Marker Y Axis Value (Remote Command Only)

Returns the marker Y value. Query only.

Mode	BASIC
Remote Command	:CALCulate:SPECTrum:MARKer[1] 2 ... 12:Y?
Example	CALC:SPEC:MARK11:Y?
Notes	When the marker is on and MarkerTrace is set to IQ, it returns I and Q values. Case #1 - MarkerTrace SPEC, I or Q: returns a single double value. >:CALC:SPEC:MARK1:Y? -2.402406506109E+001 Case #2 - MarkerTrace IQ: returns a double array of two values, the first is I, and the second is Q. >:CALC: SPEC:MARK1:Y? -3.006944493834E-003,+9.9870666467354E-004 The IQ selection is for backward compatibility purposes. It is recommended that the users use the I and/or Q selection instead. You must be in a mode that includes the Complex Spectrum measurement to use this command. Use INSTRUMENT:SElect to set the mode.
Notes	You must be in the IQ Analyzer (Basic) mode to use this command. Use INSTRUMENT:SElect to set the mode.
Preset	Result dependent on markers setup and signal source
State Saved	No
Backwards Compatibility SCPI	:CALCulate:SPECTrum:MARKer[1] 2 ... 12:FUNctioN:RESult?
Initial S/W Revision	Prior to A.02.00

Backward Compatibility SCPI Commands

Sets or queries the state of a marker. Setting a marker that is OFF to state ON or 1 puts it in Normal mode and places it at the center of the screen.

Mode	BASIC
Remote Command	:CALCulate:SPECTrum:MARKer[1] 2 ... 12:STATe OFF ON 0 1 :CALCulate:SPECTrum:MARKer[1] 2 ... 12:STATe?
Example	CALC:SPEC:MARK3:STAT ON CALC:SPEC:MARK3:STAT?
Notes	You must be in the IQ Analyzer (Basic) mode to use this command. Use INSTRument:SElect to set the mode.
Preset	OFF
State Saved	Saved in instrument state.
Range	On Off
Initial S/W Revision	Prior to A.02.00

Marker Function

Opens the Marker Function menu.

Key Path	Front-panel key
Initial S/W Revision	Prior to A.02.00

Select Marker

Displays 12 markers available for selection.

Key Path	Marker
Initial S/W Revision	Prior to A.02.00

Marker Function Type

Sets the marker control mode as described under **Normal**, **Delta** and **Off**, below. All interactions and dependencies detailed under the key description are enforced when the remote command is sent.

Key Path	Marker Function
Mode	BASIC
Remote Command	:CALCulate:SPECTrum:MARKer[1] 2 ... 12:FUNCTION NOISe BPOWer BDENsity OFF :CALCulate:SPECTrum:MARKer[1] 2 ... 12:FUNCTION?
Example	CALC:SPEC:MARK:FUNC NOISCALC:SPEC:MARK:FUNC?
Notes	You must be in the IQ Analyzer (Basic) mode to use this command. Use INSTRUMENT:SElect to set the mode.
Preset	OFF
State Saved	Saved in instrument state.
Range	Marker Noise Band/Interval Power Band Interval Density Marker Function Off
Initial S/W Revision	Prior to A.02.00

Band Adjust

Opens a menu of keys that allow you to modify the band.

Key Path	Marker Function
Initial S/W Revision	Prior to A.02.00

Band/Interval Span for Frequency Domain

Sets the width of the span for the selected marker.

Key Path	Marker Function, Band Adjust
Mode	BASIC
Remote Command	:CALCulate:SPECTrum:MARKer[1] 2 ... 12:FUNCtion:BAND:SPAN <freq> :CALCulate:SPECTrum:MARKer[1] 2 ... 12:FUNCtion:BAND:SPAN?
Example	CALC:SPEC:MARK12:FUNC:BAND:SPAN 20MHzCALC:SPEC:MARK12:FUNC:BAND:SPAN?
Notes	You must be in the IQ Analyzer (Basic) mode to use this command. Use INSTRUMENT:SElect to set the mode.
Couplings	Changing the Band/Interval Span necessarily changes the Band/Interval Left and Band/Interval Right values
Preset	10% of Span
State Saved	Saved in instrument state.
Min	0
Max	26.5GHz
Initial S/W Revision	Prior to A.02.00

Band/Interval Left for Frequency Domain

Sets the left edge frequency or time for the band of the selected marker.

Key Path	Marker Function, Band Adjust
Mode	BASIC
Remote Command	:CALCulate:SPECTrum:MARKer[1] 2 ... 12:FUNCtion:BAND:LEFT <freq> :CALCulate:SPECTrum:MARKer[1] 2 ... 12:FUNCtion:BAND:LEFT?
Example	CALC:SPEC:MARK12:FUNC:BAND:LEFT 20GHz CALC:SPEC:MARK12:FUNC:BAND:LEFT?
Notes	You must be in the IQ Analyzer (Basic) mode to use this command. Use INSTRUMENT:SElect to set the mode.
Couplings	Changing the Band/Interval Left necessarily changes the Band/Interval Span and Band/Interval Right values
Preset	5% of Span
State Saved	Saved in instrument state.
Min	0
Max	26.5GHz
Initial S/W Revision	Prior to A.02.00

Band/Interval Right for Frequency Domain

Sets the right edge frequency or time for the band of the selected marker.

Key Path	Marker Function, Band Adjust
Mode	BASIC
Remote Command	:CALCulate:SPECTrum:MARKer[1] 2 ... 12:FUNction:BAND:RIGHT <freq> :CALCulate:SPECTrum:MARKer[1] 2 ... 12:FUNction:BAND:RIGHT?
Example	CALC:SPEC:MARK12:FUNC:BAND:RIGH 20GHz CALC:SPEC:MARK12:FUNC:BAND:RIGH?
Notes	You must be in the IQ Analyzer (Basic) mode to use this command. Use INSTRument:SElect to set the mode.
Couplings	Changing the Band/Interval Right necessarily changes the Band/Interval Left and Band/Interval Span values
Preset	5% of Span
State Saved	Saved in instrument state.
Min	0
Max	26.5GHz
Initial S/W Revision	Prior to A.02.00

Marker To

Accesses menu keys that can copy the current marker value into another instrument parameter (for example, Center Freq). If the currently selected marker is not on when you press this front panel key, it is turned on at the center of the screen as a normal marker.

Key Path	Front-panel key
Initial S/W Revision	Prior to A.02.00

Mkr -> CF

Sets the center frequency to the frequency of the selected marker. The marker stays at this frequency, so it moves to the center of the display.

Key Path	Marker ->
Mode	BASIC
Remote Command	:CALCulate:SPECTrum:MARKer[1 2 ... 12[:SET]:CENTer
Example	CALC:SPEC:MARK4:CENT
Notes	In the delta marker mode, this function sets the center frequency to the x-axis value of the delta marker. If the currently selected marker is not on when this key is pressed, it is turned on at the center of the screen as a normal type marker. You must be in the IQ Analyzer (Basic) mode to use this command. Use INSTRument:SElect to set the mode.
Dependencies	This key is not available (grayed out) when the selected marker is not on the spectrum trace.
Initial S/W Revision	Prior to A.02.00

Mkr -> Ref Lvl

Sets the reference level to the amplitude value of the selected marker, moving the marked point to the reference level (top line of the graticule).

Key Path	Marker ->
Mode	BASIC
Remote Command	:CALCulate:SPECTrum:MARKer[1 2 ... 12[:SET]:RLEVel
Example	CALC:SPEC:MARK4:RLEV
Notes	Make the Marker Y value to the display reference value. If the currently selected marker is not on when this key is pressed, it is turned on at the center of the screen as a normal type marker, and its amplitude applied to the reference value. You must be in the IQ Analyzer (Basic) mode to use this command. Use INSTRument:SElect to set the mode.
Initial S/W Revision	Prior to A.02.00

Meas

The information in this section is common to all measurements. For key and remote command information for a specific measurement, refer to the section that describes the measurement of interest.

Measurements available under the Meas key are specific to the current Mode.

When viewing Help for measurements, note the following:

NOTE

Operation for some keys differs between measurements. The information displayed in Help pertains to the current measurement. To see how a key operates in a different measurement, exit Help (press the Cancel Esc key), select the measurement, then reenter Help (press the Help key) and press that key.

Key Path	Front-panel key
Initial S/W Revision	Prior to A.02.00

Remote Measurement Functions

This section contains the following topics:

["Measurement Group of Commands" on page 558](#)

["Current Measurement Query \(Remote Command Only\)" on page 560](#)

["Limit Test Current Results \(Remote Command Only\)" on page 560](#)

["Data Query \(Remote Command Only\)" on page 560](#)

["Calculate/Compress Trace Data Query \(Remote Command Only\)" on page 561](#)

["Calculate Peaks of Trace Data \(Remote Command Only\)" on page 566](#)

[Hardware-Accelerated Fast Power Measurement \(Remote Command Only\)](#)

["Format Data: Numeric Data \(Remote Command Only\)" on page 567](#)

["Format Data: Byte Order \(Remote Command Only\)" on page 568](#)

Initial S/W Revision	Prior to A.02.00
----------------------	------------------

Measurement Group of Commands

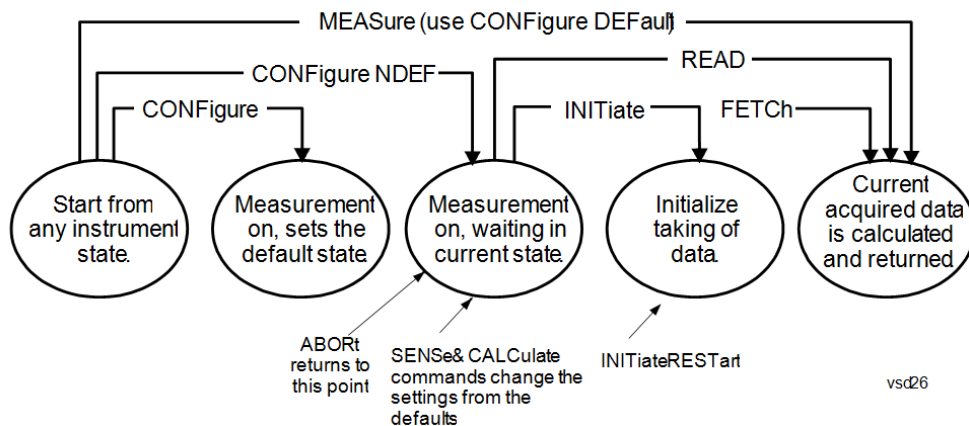

Measure Commands:

:MEASure:<measurement>[n]?

This is a fast single-command way to make a measurement using the factory default instrument settings. These are the settings and units that conform to the Mode Setup settings (e.g. radio standard) that you have currently selected.

- Stops the current measurement (if any) and sets up the instrument for the specified measurement using the factory defaults
- Initiates the data acquisition for the measurement
- Blocks other SCPI communication, waiting until the measurement is complete before returning results.
- If the function does averaging, it is turned on and the number of averages is set to 10.
- After the data is valid it returns the scalar results, or the trace data, for the specified measurement. The type of data returned may be defined by an [n] value that is sent with the command.
- The scalar measurement results will be returned if the optional [n] value is not included, or is set to 1. If the [n] value is set to a value other than 1, the selected trace data results will be returned. See each command for details of what types of scalar results or trace data results are available.
- ASCII is the default format for the data output. (Older versions of Spectrum Analysis and Phase Noise mode measurements only use ASCII.) The binary data formats should be used for handling large blocks of data since they are smaller and faster than the ASCII format. Refer to the FORMat:DATA command for more information.

If you need to change some of the measurement parameters from the factory default settings you can set up the measurement with the CONFigure command. Use the commands in the SENSE:<measurement> and CALCulate:<measurement> subsystems to change the settings. Then you can use the READ? command to initiate the measurement and query the results.

If you need to repeatedly make a given measurement with settings other than the factory defaults, you can use the commands in the SENSE:<measurement> and CALCulate:<measurement> subsystems to set up the measurement. Then use the READ? command to initiate the measurement and query results.

Measurement settings persist if you initiate a different measurement and then return to a previous one. Use READ:<measurement>? if you want to use those persistent settings. If you want to go back to the default settings, use MEASure:<measurement>?.

Configure Commands:

:CONFigure:<measurement>

This command stops the current measurement (if any) and sets up the instrument for the specified measurement using

the factory default instrument settings. It does not initiate the taking of measurement data unless INIT:CONTInuous is ON. If you change any measurement settings after using the CONFigure command, the READ command can be used to initiate a measurement without changing the settings back to their defaults.

In the Swept SA measurement in Spectrum Analyzer mode the CONFigure command also turns the averaging function on and sets the number of averages to 10 for all measurements.

:CONFigure: <measurement>: NDEFault stops the current measurement and changes to the specified measurement. It does not change the settings to the defaults. It does not initiate the taking of measurement data unless INIT:CONTInuous is ON.

The CONFigure? query returns the current measurement name.

The CONFigure:CATalog? query returns a quoted string of all licensed measurement names in the current mode. For example, "SAN, CHP, OBW, ACP, PST, TXP, SPUR, SEM, LIST".

Fetch Commands:

:FETCh:<measurement>[n]?

This command puts selected data from the most recent measurement into the output buffer. Use FETCh if you have already made a good measurement and you want to return several types of data (different [n] values, for example, both scalars and trace data) from a single measurement. FETCh saves you the time of re-making the measurement. You can only FETCh results from the measurement that is currently active, it will not change to a different measurement. An error message is reported if a measurement other than the current one is specified.

If you need to get new measurement data, use the READ command, which is equivalent to an INITiate followed by a FETCh.

The scalar measurement results will be returned if the optional [n] value is not included, or is set to 1. If the [n] value is set to a value other than 1, the selected trace data results will be returned. See each command for details of what types of scalar results or trace data results are available. The binary data formats should be used for handling large blocks of data since they are smaller and transfer faster than the ASCII format. (FORMat:DATA)

FETCh may be used to return results other than those specified with the original READ or MEASure command that you sent.

INITiate Commands:

:INITiate:<measurement>

This command is not available for measurements in all the instrument modes:

- Initiates a trigger cycle for the specified measurement, but does not output any data. You must then use the FETCh<meas> command to return data. If a measurement other than the current one is specified, the instrument will switch to that measurement and then initiate it.
- For example, suppose you have previously initiated the ACP measurement, but now you are running the channel power measurement. If you send INIT:ACP? it will change from channel power to ACP and will initiate an ACP measurement.
- Does not change any of the measurement settings. For example, if you have previously started the ACP measurement and you send INIT:ACP? it will initiate a new ACP measurement using the same instrument settings as the last time ACP was run.
- If your selected measurement is currently active (in the idle state) it triggers the measurement, assuming the trigger conditions are met. Then it completes one trigger cycle. Depending upon the measurement and the number of averages, there may be multiple data acquisitions, with multiple trigger events, for one full trigger cycle. It also holds off additional commands on GPIB until the acquisition is complete.

READ Commands:

:READ:<measurement>[n]?

- Does not preset the measurement to the factory default settings. For example, if you have previously initiated the ACP
-

measurement and you send READ:ACP? it will initiate a new measurement using the same instrument settings.

- Initiates the measurement and puts valid data into the output buffer. If a measurement other than the current one is specified, the instrument will switch to that measurement before it initiates the measurement and returns results.
 - For example, suppose you have previously initiated the ACP measurement, but now you are running the channel power measurement. Then you send READ:ACP? It will change from channel power back to ACP and, using the previous ACP settings, will initiate the measurement and return results.
 - Blocks other SCPI communication, waiting until the measurement is complete before returning the results
 - If the optional [n] value is not included, or is set to 1, the scalar measurement results will be returned. If the [n] value is set to a value other than 1, the selected trace data results will be returned. See each command for details of what types of scalar results or trace data results are available. The binary data formats should be used when handling large blocks of data since they are smaller and faster than the ASCII format. (FORMat:DATA)
-

Initial S/W Revision	Prior to A.02.00
----------------------	------------------

Current Measurement Query (Remote Command Only)

This command returns the name of the measurement that is currently running.

Remote Command	:CONFigure?
-----------------------	-------------

Example	CONF?
----------------	-------

Initial S/W Revision	Prior to A.02.00
----------------------	------------------

Limit Test Current Results (Remote Command Only)

Queries the status of the current measurement limit testing. It returns a 0 if the measured results pass when compared with the current limits. It returns a 1 if the measured results fail any limit tests.

Remote Command	:CALCulate:CLIMits:FAIL?
-----------------------	--------------------------

Example	CALC:CLIM:FAIL? queries the current measurement to see if it fails the defined limits. Returns a 0 or 1: 0 it passes, 1 it fails.
----------------	--

Initial S/W Revision	Prior to A.02.00
----------------------	------------------

Data Query (Remote Command Only)

Returns the designated measurement data for the currently selected measurement and subopcode.

n = any valid subopcode for the current measurement. See the measurement command results table for your current measurement, for information about what data is returned for the subopcodes.

This command uses the data setting specified by the FORMat:BORDER and FORMat:DATA commands and can return real or ASCII data. (See the format command descriptions under Input/Output in the Analyzer Setup section.)

Remote Command	:CALCulate:DATA[n]?
Notes	The return trace depends on the measurement. In CALCulate:<meas>:DATA[n], n is any valid subopcode for the current measurement. It returns the same data as the FETCH:<measurement>? query where <measurement> is the current measurement.
Initial S/W Revision	Prior to A.02.00

Calculate/Compress Trace Data Query (Remote Command Only)

Returns compressed data for the currently selected measurement and sub-opcode [n].

n = any valid sub-opcode for that measurement. See the MEASure:<measurement>? command description of your specific measurement for information on the data that can be returned.

The data is returned in the current Y Axis Unit of the analyzer. The command is used with a sub-opcode <n> (default=1) to specify the trace. With trace queries, it is best if the analyzer is not sweeping during the query. Therefore, it is generally advisable to be in Single Sweep, or Update=Off.

This command is used to compress or decimate a long trace to extract and return only the desired data. A typical example would be to acquire N frames of GSM data and return the mean power of the first burst in each frame. The command can also be used to identify the best curve fit for the data.

Remote Command	:CALCulate:DATA<n>:COMPRESS? BLOCK CFIT MAXimum MINimum MEAN DMEan RMS RMSCubed SAMPLE SDEVIation PPHase [,<soffset> [,<length>[,<roffset>[,<rlimit>]]]]
Example	To query the mean power of a set of GSM bursts: Supply a signal that is a set of GSM bursts. Select the IQ Waveform measurement (in IQ Analyzer Mode). Set the sweep time to acquire at least one burst. Set the triggers such that acquisition happens at a known position relative to a burst. Then query the mean burst levels using, CALC:DATA2:COMP? MEAN, 24e-6, 526e-6 (These parameter values correspond to GSM signals, where 526e-6 is the length of the burst in the slot and you just want 1 burst.)
Notes	The command supports 5 parameters. Note that the last 4 (<soffset>, <length>, <roffset>, <rlimit>) are optional. But these optional parameters must be entered in the specified order. For example, if you want to specify <length>, then you must also specify <soffset>. See details below for a definition of each of these parameters. This command uses the data in the format specified by FORMat:DATA, returning either binary or ASCII data.
Initial S/W Revision	Prior to A.02.00

- BLOCK or block data - returns all the data points from the region of the trace data that you specify. For example, it could be used to return the data points of an input signal over several timeslots, excluding the portions of the trace data that you do not want. (This is x,y pairs for trace data and I,Q pairs for complex data.)

- CFIT or curve fit - applies curve fitting routines to the data. <soffset> and <length> are required to define the data that you want. <roffset> is an optional parameter for the desired order of the curve equation. The query will return the following values: the x-offset (in seconds) and the curve coefficients ((order + 1) values).

MIN, MAX, MEAN, DME, RMS, RMSC, SAMP, SDEV and PPH return one data value for each specified region (or <length>) of trace data, for as many regions as possible until you run out of trace data (using <roffset> to specify regions). Or they return the number of regions you specify (using <rlimit>) ignoring any data beyond that.

- MINimum - returns the minimum data point (y value) for the specified region(s) of trace data. For I/Q trace data, the minimum magnitude of the I/Q pairs is returned.
- MAXimum - returns the maximum data point (y value) for the specified region(s) of trace data. For I/Q trace data, the maximum magnitude of the I/Q pairs is returned.
- MEAN - returns a single value that is the arithmetic mean of the data point values (in dB/ dBm) for the specified region(s) of trace data. For I/Q trace data, the mean of the magnitudes of the I/Q pairs is returned. See the following equations.

NOTE If the original trace data is in dB, this function returns the arithmetic mean of those log values, not log of the mean power which is a more useful value. The mean of the log is the better measurement technique when measuring CW signals in the presence of noise. The mean of the power, expressed in dB, is useful in power measurements such as Channel Power. To achieve the mean of the power, use the RMS option.

Equation 1

Mean Value of Data Points for Specified Region(s)

$$\text{MEAN} = \frac{1}{n} \sum_{X_i \in \text{region}(s)} X_i$$

where X_i is a data point value, and n is the number of data points in the specified region(s).

Equation 2

Mean Value of I/Q Data Pairs for Specified Region(s)

$$\text{MEAN} = \frac{1}{n} \sum_{X_i \in \text{region}(s)} |X_i|$$

where $|X_i|$ is the magnitude of an I/Q pair, and n is the number of I/Q pairs in the specified region(s).

- DMEan - returns a single value that is the mean power (in dB/ dBm) of the data point values for the specified region(s) of trace data. See the following equation:

Equation 3

DMEan Value of Data Points for Specified Region(s)

$$\text{DME} = 10 \times \log_{10} \left(\frac{1}{n} \sum_{X_i \in \text{region}(s)} 10^{\frac{X_i}{10}} \right)$$

- RMS - returns a single value that is the average power on a root-mean-squared voltage scale (arithmetic rms) of the data point values for the specified region(s) of trace data. See the following equation.

NOTE For I/Q trace data, the rms of the magnitudes of the I/Q pairs is returned. See the following equation. This function is very useful for I/Q trace data. However, if the original trace data is in dB, this function returns the rms of the log values which is not usually needed.

Equation 4

RMS Value of Data Points for Specified Region(s)

$$\text{RMS} = \sqrt{\frac{1}{n} \sum_{X_i \in \text{region}(s)} X_i^2}$$

where X_i is a data point value, and n is the number of data points in the specified region(s).

Equation 5

RMS Value of I/Q Data Pairs for Specified Region(s)

$$\text{RMS} = \sqrt{\frac{1}{n} \sum_{X_i \in \text{region}(s)} X_i X_i^*}$$

where X_i is the complex value representation of an I/Q pair, X_i^* its conjugate complex number, and n is the number of I/Q pairs in the specified region(s).

Once you have the rms value for a region of trace data (linear or I/Q), you may want to calculate the mean power. You must convert this rms value (peak volts) to power in dBm:

$$10 \times \log[10 \times (\text{rms value})^2]$$

- SAMPlE - returns the first data value (x,y pair) for the specified region(s) of trace data. For I/Q trace data, the first I/Q pair is returned.
- SDEVIation - returns a single value that is the arithmetic standard deviation for the data point values for the specified region(s) of trace data. See the following equation.
- For I/Q trace data, the standard deviation of the magnitudes of the I/Q pairs is returned. See the following equation.

Equation 6

Standard Deviation of Data Point Values for Specified Region(s)

$$\text{SDEV} = \sqrt{\frac{1}{n} \sum_{X_i \in \text{region}(s)} (X_i - \bar{X})^2}$$

where X_i is a data point value, \bar{X} is the arithmetic mean of the data point values for the specified region (s), and n is the number of data points in the specified region(s).

$$\text{SDEV} = \sqrt{\frac{1}{n} \sum_{X_i \in \text{region}(s)} (|X_i| - \bar{X})^2}$$

where $|X_i|$ is the magnitude of an I/Q pair, \bar{X} is the mean of the magnitudes for the specified region(s), and n is the number of data points in the specified region(s).

- PPHase - returns the x,y pairs of both rms power (dBm) and arithmetic mean phase (radian) for every specified region and frequency offset (Hz). The number of pairs is defined by the specified number of regions. This parameter can be used for I/Q vector ($n=0$) in Waveform (time domain) measurement and all parameters are specified by data point in PPHase.

The rms power of the specified region may be expressed as:

$$\text{Power} = 10 \times \log [10 \times (\text{RMS I/Q value})] + 10.$$

The RMS I/Q value (peak volts) is:

$$\sqrt{\frac{1}{n} \sum_{X_i \in \text{region}} X_i X_i^*}$$

where X_i is the complex value representation of an I/Q pair, X_i^* its conjugate complex number, and n is the number of I/Q pairs in the specified region.

The arithmetic mean phase of the specified region may be expressed as:

$$\frac{1}{n} \sum_{Y_i \in \text{region}} Y_i$$

where Y_i is the unwrapped phase of I/Q pair with applying frequency correction and n is the number of I/Q pairs in the specified region.

The frequency correction is made by the frequency offset calculated by the arithmetic mean of every specified region's frequency offset. Each frequency offset is calculated by the least square method against the unwrapped phase of I/Q pair.

Sample Trace Data - Constant Envelope

(See below for explanation of variables.)

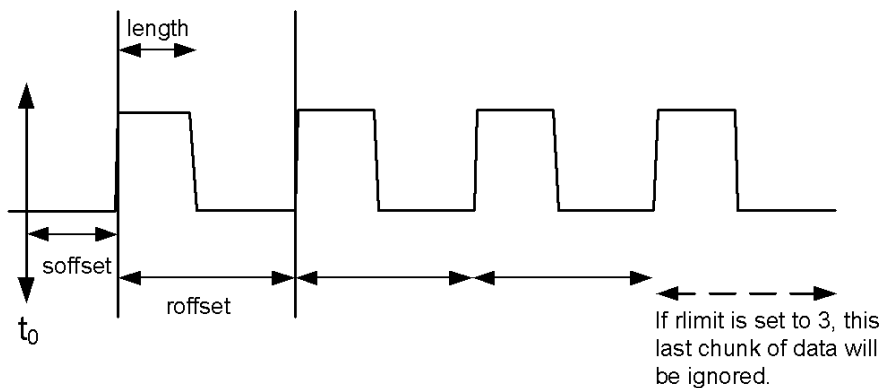

Sample Trace Data - Not Constant Envelope

(See below for explanation of variables.)

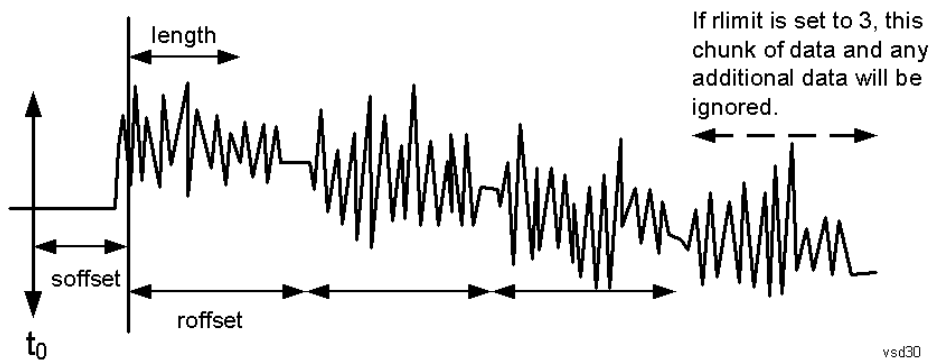

<soffset> - start offset is an optional real number. (It is in seconds for time-domain traces, and is a dimensionless index 0 to $N_{\text{points}} - 1$, for frequency-domain traces). It specifies the amount of data at the beginning of the trace that will be ignored before the decimation process starts. It is the time or frequency change from the start of the trace to the point where you want to start using the data. The default value is zero.

<length> - is an optional real number. (It is in seconds for time-domain traces, and is a dimensionless index 0 to $N_{\text{points}} - 1$, for frequency-domain traces). It defines how much data will be compressed into one value. This parameter has a default value equal to the current trace length.

<roffset> - repeat offset is an optional real number. (It is in seconds for time-domain traces, and is a dimensionless index 0 to $N_{\text{points}} - 1$, for frequency-domain traces). It defines the beginning of the next field of trace elements to be compressed. This is relative to the beginning of the previous field. This parameter has a default value equal to the <length> variable. Note that this parameter is used for a completely different purpose when curve fitting (see CFIT above).

<rlimit> - repeat limit is an optional integer. It specifies the number of data items that you want returned. It will ignore any additional items beyond that number. You can use the Start offset and the Repeat limit to pick out exactly what part of the data you want to use. The default value is all the data.

Calculate Peaks of Trace Data (Remote Command Only)

Returns a list of all the peaks for the currently selected measurement and sub-opcode [n]. The peaks must meet the requirements of the peak threshold and excursion values.

n = any valid sub-opcode for the current measurement. See the MEASure:<measurement> command description of your specific measurement for information on the data that can be returned.

The command can only be used with specific sub-opcodes with measurement results that are trace data. Both real and complex traces can be searched, but complex traces are converted to magnitude in dBm. In many measurements the sub-opcode n=0, is the raw trace data which cannot be searched for peaks. And Sub-opcode n=1, is often calculated results values which also cannot be searched for peaks.

This command uses the data setting specified by the FORMat:BORDER and FORMat:DATA commands and can return real or ASCII data. If the format is set to INT,32, it returns REAL,32 data.

The command has four types of parameters:

- Threshold (in dBm)
- Excursion (in dB)
- Sorting order (amplitude, frequency, time)
- Optional in some measurements: Display line use (all, > display line, < display line)

Remote Command	<p>For Swept SA measurement:</p> <pre>:CALCulate:DATA[1] 2 ... 6:PEAKs? <threshold>,<excursion>[,AMPLitude FREQuency TIME[,ALL GTDLine LTDLine]]</pre> <p>For most other measurements:</p> <pre>:CALCulate:DATA[1] 2 ... 6:PEAKs? <threshold>,<excursion>[,AMPLitude FREQuency TIME]</pre>
-----------------------	--

Example	<p>Example for Swept SA measurement in Spectrum Analyzer Mode:</p> <p>CALC:DATA4:PEAK? -40, 10, FREQ, GTDL This will identify the peaks of trace 4 that are above -40 dBm, with excursions of at least 10 dB. The peaks are returned in order of increasing frequency, starting with the lowest frequency. Only the peaks that are above the display line are returned.</p> <p>Query Results 1:</p> <p>With FORMat:DATA REAL, 32 selected, it returns a list of floating-point numbers. The first value in the list is the number of peak points that are in the following list. A peak point consists of two values: a peak amplitude followed by its corresponding frequency (or time).</p> <p>If no peaks are found the peak list will consist of only the number of peaks, (0).</p>
----------------	---

Notes	<p><n> - is the trace that will be used</p> <p><threshold> - is the level below which trace data peaks are ignored. Note that the threshold value is required and is always used as a peak criterion. To effectively disable the threshold criterion for this command, provide a substantially low threshold value such as -200 dBm. Also note that the threshold value used in this command is independent of and has no effect on the threshold value stored under the Peak Criteria menu.</p> <p><excursion> - is the minimum amplitude variation (rise and fall) required for a signal to be identified as peak. Note that the excursion value is required and is always used as a peak criterion. To effectively disable the excursion criterion for this command, provide the minimum value of 0.0 dB. Also note that the excursion value used in this command is independent of and has no effect on the</p>
--------------	---

excursion value stored under the Peak Criteria menu.

Values must be provided for threshold and excursion. The sorting and display line parameters are optional (defaults are AMPLitude and ALL).

Note that there is always a Y-axis value for the display line, regardless of whether the display line state is on or off. It is the current Y-axis value of the display line which is used by this command to determine whether a peak should be reported. Sorting order:

AMPLitude - lists the peaks in order of descending amplitude, with the highest peak first (default if optional parameter not sent)

FREQUency - lists the peaks in order of occurrence, left to right across the x-axis.

TIME - lists the peaks in order of occurrence, left to right across the x-axis.

Peaks vs. Display Line:

ALL - lists all of the peaks found (default if optional parameter not sent).

GTDLine (greater than display line) - lists all of the peaks found above the display line.

LTDLine (less than display line) - lists all of the peaks found below the display line.

Initial S/W Revision Prior to A.02.00

Format Data: Numeric Data (Remote Command Only)

This command specifies the format of the trace data input and output. It specifies the formats used for trace data during data transfer across any remote port. It affects only the data format for setting and querying trace data for the :TRACe[:DATA], TRACe[:DATA]?, :CALCulate:DATA[n]? and FETCh:SANalyzer[n]? commands and queries.

Remote Command	:FORMat[:TRACe][:DATA] ASCii INTeger,32 REAL,32 REAL,64 :FORMat[:TRACe][:DATA]?
Notes	The query response is: ASCii: ASC,8 REAL,32: REAL,32 REAL,64: REAL,64 INTeger,32: INT,32 When the numeric data format is REAL or ASCii, data is output in the current Y Axis unit. When the data format is INTeger, data is output in units of m dBm (.001 dBm). The INT,32 format returns binary 32-bit integer values in internal units (m dBm), in a definite length block.
Dependencies	Sending a data format spec with an invalid number (for example, INT,48) generates no error. The analyzer simply uses the default (8 for ASCii, 32 for INTeger, 32 for REAL). Sending data to the analyzer which does not conform to the current FORMat specified, results in an error. Sending ASCII data when a definite block is expected generates message -161 "Invalid Block Data" and sending a definite block when ASCII data is expected generates message -121 "Invalid Character in Number".
Preset	ASCii
Backwards Compatibility Notes	Note that the INT,32 format is only applicable to the command, TRACe:DATA. This preserves backwards compatibility for the Swept SA measurement. For all other commands/queries which honor FORMat:DATA, if INT,32 is sent the analyzer will behave as though it were set to REAL,32.

Initial S/W Revision	Prior to A.02.00
----------------------	------------------

The specs for each output type follow:

ASCIi - Amplitude values are in ASCII, in the current Y Axis Unit, one ASCII character per digit, values separated by commas, each value in the form:

SX.YYYYYEsZZ

Where:

S = sign (+ or -)

X = one digit to left of decimal point

Y = 5 digits to right of decimal point

E = E, exponent header

s = sign of exponent (+ or -)

ZZ = two digit exponent

REAL,32 - Binary 32-bit real values in the current Y Axis Unit, in a definite length block.

REAL,64 - Binary 64-bit real values in the current Y Axis Unit, in a definite length block.

Format Data: Byte Order (Remote Command Only)

This command selects the binary data byte order for data transfer and other queries. It controls whether binary data is transferred in normal or swapped mode. This command affects only the byte order for setting and querying trace data for the :TRACe[:DATA], TRACe[:DATA]? , :CALCulate:DATA[n]? and FETCh:SANalyzer[n]? commands and queries.

By definition any command that says it uses FORMat:DATA uses any format supported by FORMat:DATA.

The NORMal order is a byte sequence that begins with the most significant byte (MSB) first, and ends with the least significant byte (LSB) last in the sequence: 1|2|3|4. SWAPped order is when the byte sequence begins with the LSB first, and ends with the MSB last in the sequence: 4|3|2|1.

Remote Command	:FORMat:BORDer NORMal SWAPped :FORMat:BORDer?
-----------------------	--

Preset	NORMal
--------	--------

Initial S/W Revision	Prior to A.02.00
----------------------	------------------

Meas Setup

Opens the menu that allows you to set up the measurement parameters.

Key Path	Front-panel key
Initial S/W Revision	Prior to A.02.00

Avg/Hold Num

Sets the number of 'sweeps' that are averaged. After the specified number of 'sweeps' (average counts), the averaging mode (terminal control) setting determines the averaging action.

Key Path	Meas Setup
Mode	BASIC
Remote Command	[:SENSe]:SPECtrum:AVERage:COUNT <integer> [:SENSe]:SPECtrum:AVERage:COUNT? [:SENSe]:SPECtrum:AVERage[:STATe] ON OFF 1 0 [:SENSe]:SPECtrum:AVERage[:STATe]?
Example	SPEC:AVER:COUN 10 SPEC:AVER:COUN? SPEC:AVER 0 SPEC:AVER?
Notes	You must be in the IQ Analyzer (Basic) mode to use this command. Use INSTRument:SElect to set the mode.
Preset	25 ON
State Saved	Saved in instrument state.
Min	1
Max	20001
Initial S/W Revision	Prior to A.02.00

Avg Mode

Selects the type of termination control used for the averaging function. This determines the averaging action after the specified number of sweeps (average count) is reached.

- EXPonential - Each successive data acquisition after the average count is reached, is exponentially weighted and combined with the existing average.
- REPeat - After reaching the average count, the averaging is reset and a new average is started.

Key Path	Meas Setup
----------	-------------------

Mode	BASIC
Remote Command	[:SENSe] :SPEctrum:AVERage:TCONtrol EXPonential REPeat [:SENSe] :SPEctrum:AVERage:TCONtrol?
Example	SPEC:AVER:TCON REP SPEC:AVER:TCON?
Notes	You must be in the IQ Analyzer (Basic) mode to use this command. Use INSTRument:SElect to set the mode.
Preset	EXPonential
State Saved	Saved in instrument state.
Range	Exp Repeat
Initial S/W Revision	Prior to A.02.00

Avg Type

Allows selection of the averaging type.

- Pwr Avg (RMS) - The power is averaged, providing the rms of the voltage. LOG
- Log Pwr Avg (Video) - The log of the power is averaged.
- Voltage Avg - The voltage is averaged.

Key Path	Meas Setup
Mode	BASIC
Remote Command	[:SENSe] :SPEctrum:AVERage:TYPE RMS LOG SCALar [:SENSe] :SPEctrum:AVERage:TYPE?
Example	SPEC:AVER:TYPE RMS SPEC:AVER:TYPE?
Notes	You must be in the IQ Analyzer (Basic) mode to use this command. Use INSTRument:SElect to set the mode. Pwr Avg (RMS) = RMS Log Pwr Avg (Video) = LOG Voltage Avg = SCALar
Preset	LOG
State Saved	Saved in instrument state.
Range	Pwr Avg(RMS) Log-Pwr Avg(Video) Voltage Avg
Initial S/W Revision	Prior to A.02.00

Advanced

Opens a menu of advanced settings for the complex spectrum measurement.

Key Path	Meas Setup
Initial S/W Revision	Prior to A.02.00

Digital IF BW

Allows you to select the type of IF filter (post ADC, digital filter) that is used. This is an advanced control that normally does not need to be changed.

The Digital IF bandwidth is determined from the Span. The Digital IF BW and Span relation is determined by the following formula.

$$\text{Digital IF BW} = \text{Span} \times 1.5$$

This equation holds except for the case when only the value is clipped to the max value. Furthermore, when Option DP2, B40, or wider IF Bandwidth option is installed, continuous bandwidth setting is possible. For any other configuration, only fixed bandwidth values are available and quantizing the bandwidth values becomes necessary.

(When Option DP2, B40, or wider IF Bandwidth option is installed)

Continuous bandwidth setting is available in this configuration. Hence the theoretical coupling equation above with span is used in all cases except when the bandwidth reaches the maximum value, which in this case, is clipped to the maximum value.

Note that if the Digital IF BW state is set to Man , any value greater than the Span is settable.

There are coupling dependencies with the IF Path Selection parameter. The IF Path Selection determines the maximum value and maximum resolution values. For instance, even with the B40 and B1X options installed on a PXA, if the IF Path Selection is set to 25 MHz with the IF Path Auto set OFF, the maximum bandwidth value will be clipped to 25 MHz.

(For all other configurations)

The Digital IF BW parameter directly sets the digital IF filter bandwidth, which can only be set to certain fixed discrete values. Thus, the theoretical value of the Digital IF bandwidth will be derived first. Then the closest discrete bandwidth value will be selected from the filter table.. The exception is 25 MHz where, if the theoretical value exceeds 10 MHz, the 25 MHz bandwidth will automatically be selected.

For example, if you set the Span to 2.9 MHz and 3.0 MHz, the theoretical Digital IF BW value will be as follows.

$$\text{Digital IF Bw} = (2.9 \text{ MHz}) \times 1.5 = 4.35 \text{ MHz}$$

$$\text{Digital IF Bw} = (3.0 \text{ MHz}) \times 1.5 = 4.5 \text{ MHz}$$

If you have the Flattop filter selected, only 4 MHz and 5 MHz bandwidths are available. For in-between values, the next widest possible value is selected. In this case, both 4.35 MHz and 4.5 MHz are rounded to 5 MHz.

Key Path	Meas Setup, Advanced
Mode	BASIC
Remote Command	<pre>[:SENSe] :SPECTrum:DIF:BA NDwidth <freq> [:SENSe] :SPECTrum:DIF:BA NDwidth? [:SENSe] :SPECTrum:DIF:BA NDwidth:AUTO ON OFF 1 0 [:SENSe] :SPECTrum:DIF:BA NDwidth:AUTO?</pre>
Example	<pre>SPEC:DIF:BA ND 1MHz SPEC:DIF:BA ND? SPEC:DIF:BA ND:AUTO 0 SPEC:DIF:BA ND:AUTO?</pre>
Notes	You must be in the IQ Analyzer (Basic) mode to use this command. Use INSTRUMENT:SElect to set the mode.
Dependencies	For applications that have the IF Path Selection menu such as the BASIC mode, if IF Path Auto is OFF, the maximum value depends on which IF Path is currently selected. If 10 MHz, 25 MHz, 40 MHz, 85 MHz, 125 MHz, 140 MHz or 160 MHz path is selected, the maximum value of this parameter will be 10, 25, 40, 85, 125, 140 or 160 MHz respectively. If IF Path Auto is ON, the maximum value will be the maximum Digital IF BW available in the instrument regardless of the current IF Path selection. For example, if the instrument has the options B25, B40 and B1X installed, clearly the maximum available Digital IF BW of the instrument is 140 MHz. Thus if IF Path Auto is ON and IF Path selection is B25M, the maximum Digital IF BW is not limited to 25 MHz but is 140 MHz.
Couplings	<p>The bandwidth of the IF Filter is coupled to the span by the following equations.</p> <p>Digital IF BW = Span * 1.5 (When Option DP2, B40, or wider IF Bandwidth option is installed)</p> <p>Digital IF BW = Span * 1.5 is used as is, since continuous bandwidths are allowed. (For all other configurations)</p> <p>Since the Digital IF BW can only be set to discrete values, Digital IF BW is not always set by the exact value above.</p> <p>If the HW cannot set to the exact value of the requested Digital IF BW, it uses “the next wider bandwidth value” available.</p> <p>For instance, a Digital IF BW requested to be set at 3.01 MHz is quantized to 3.1 MHz in the UI and hardware.</p>
Preset	<p>Hardware Dependent:</p> <p>No Option = 10.0 MHz Option B25 = 25.0 MHz Option B40 or wider IF BW = 12.0 MHz</p>
State Saved	Saved in instrument state.

Min	10 Hz
Max	Hardware Dependent: RF Input: No Option = 10 MHz Option B25 = 25 MHz Option B40 = 40.0 MHz Option B85 = 85.0 MHz Option B1A = 125.0 MHz Option B1X = 140.0 MHz Option B1Y = 160.0 MHz
Backwards Compatibility SCPI	[:SENSe] :SPECTrum: BANDwidth: PFFT [:SIZE] [:SENSe] :SPECTrum: BWIDth: PFFT [:SIZE] [:SENSe] :SPECTrum: BANDwidth BWIDth: IF [:SIZE]
Initial S/W Revision	Prior to A.02.00
Modified at S/W Revision	A.13.00

Filter Type

This parameter allows you to select the type of IF filter (post ADC, digital filter) that is used. This is an advanced control that normally does not need to be changed.

Key Path	Meas Setup, Advanced
Mode	BASIC
Remote Command	[:SENSe] :SPECTrum: DIF: FILTer: TYPE GAUSSian FLATtop SNYQuist RSNYquist RCOSine RRCosine [:SENSe] :SPECTrum: DIF: FILTer: TYPE?
Example	SPEC: DIF: FILT: TYPE GAUS SPEC: DIF: FILT: TYPE?
Dependencies	Gaussian and Flattop are available in all DIF configurations. For the other filter types, the filters are only available when Option DP2, B40, or wider IF Bandwidth option is installed.
Preset	FLAT
State Saved	Saved in instrument state.
Range	Gaussian Flattop When Option DP2, B40, or wider IF Bandwidth option is installed, the range is as follows. Gaussian Flattop Short Nyquist Root Short Nyquist Raised Cosine Root RaisedCosine
Backwards Compatibility SCPI	[:SENSe] :SPECTrum: BANDwidth: PFFT: TYPE [:SENSe] :SPECTrum: BWIDth: PFFT: TYPE [:SENSe] :SPECTrum: BANDwidth BWIDth: IF: SHAPE

Initial S/W Revision	Prior to A.02.00
Modified at S/W Revision	A.13.00

Filter Type

This parameter allows you to select the type of IF filter (post ADC, digital filter) that is used. This is an advanced control that normally does not need to be changed.

Key Path	Meas Setup, Advanced
Mode	BASIC
Remote Command	[:SENSe] :SPEcTrum:DIF:FILTer:TYPE GAUSSian FLATtop SNYQuist RSNYquist RCOSine RRCosine [:SENSe] :SPEcTrum:DIF:FILTer:TYPE?
Example	SPEC:DIF:FILT:TYPE GAUS SPEC:DIF:FILT:TYPE?
Dependencies	Gaussian and Flattop are available in all DIF configurations. For the other filter types, the filters are only available when Option DP2, B40, or wider IF Bandwidth option is installed.
Preset	FLAT
State Saved	Saved in instrument state.
Range	Gaussian Flattop When Option DP2, B40, or wider IF Bandwidth option is installed, the range is as follows. Gaussian Flattop Short Nyquist Root Short Nyquist Raised Cosine Root RaisedCosine
Backwards Compatibility SCPI	[:SENSe] :SPEcTrum:BAWdth:PFfT:TYPE [:SENSe] :SPEcTrum:BWIDth:PFfT:TYPE [:SENSe] :SPEcTrum:BAWdth BWIDth:IF:SHAPE
Initial S/W Revision	Prior to A.02.00
Modified at S/W Revision	A.13.00

Sample Rate (Remote Command Only)

Sample rate is not arbitrarily configurable for the Complex Spectrum measurement since everything from Span, IF BW, Window length and FFT length is affected. Thus there is no soft key menu and SCPI is query only. If you need to set an arbitrary sample rate, you will need to use the Waveform measurement.

Mode	BASIC
Remote Command	[:SENSe] :SPEcTrum:SRATe?
Example	SPEC:SRAT?
Notes	SCPI only and query only.

Dependencies	Depends on the Digital IF BW value
State Saved	No
Min	12.5 Hz
Max	Default: 45 MHz Option B40: 50 MHz Option B85: 106.25 MHz Option B1A: 156.25 MHz Option B1X: 175 MHz Option B1Y: 200 MHz
Modified at S/W Revision	A.13.00

Sample Rate (Remote Command Only)

Sample rate is not arbitrarily configurable for the Complex Spectrum measurement since everything from Span, IF BW, Window length and FFT length is affected. Thus there is no soft key menu and SCPI is query only. If you need to set an arbitrary sample rate, you will need to use the Waveform measurement.

Mode	BASIC
Remote Command	[:SENSe] :SPECTrum:SRATe?
Example	SPEC:SRAT?
Notes	SCPI only and query only.

Dependencies	Depends on the Digital IF BW value
State Saved	No
Min	12.5 Hz
Max	Default: 45 MHz Option B40: 50 MHz Option B85: 106.25 MHz Option B1A: 156.25 MHz Option B1X: 175 MHz Option B1Y: 200 MHz
Modified at S/W Revision	A.13.00

Filter Bandwidth

This is only available when Option DP2, B40, or wider IF Bandwidth option is installed.

Key Path	Meas Setup, Advanced
Mode	BASIC

Remote Command	<pre>[:SENSe] :SPEctrum:DIF:FILTer:BAWdwidth <freq> [:SENSe] :SPEctrum:DIF:FILTer:BAWdwidth? [:SENSe] :SPEctrum:DIF:FILTer:BAWdwidth:AUTO ON OFF 1 0 [:SENSe] :SPEctrum:DIF:FILTer:BAWdwidth:AUTO?</pre>
Example	<pre>SPEC:DIF:FILT:BAND 1MHz SPEC:DIF:FILT:BAND? SPEC:DIF:FILT:BAND:AUTO 0 SPEC:DIF:FILT:BAND:AUTO?</pre>
Notes	You must be in the IQ Analyzer (Basic) mode to use this command. Use INSTRUMENT:SElect to set the mode.
Dependencies	This feature is only available when Option DP2, B40, or wider IF Bandwidth option is installed.
Couplings	Sets the same value as the current Digital IF BW value upon a preset or when Channel Filter Bandwidth Auto is ON.
Preset	Same value as Digital IF Bw ON
State Saved	Saved in instrument state.
Min	10 Hz
Max	Clipped to the current Digital IF Bw value.
Modified at S/W Revision	A.13.00

Channel Filter Alpha

Sets the filter alpha for the DIF filter. This feature is only available when Option DP2, B40, or wider IF Bandwidth option is installed.

Key Path	Meas Setup, Advanced
Mode	BASIC
Remote Command	<pre>[:SENSe] :SPEctrum:DIF:FILTer:ALPHa <real> [:SENSe] :SPEctrum:DIF:FILTer:ALPHa?</pre>
Example	<pre>SPEC:DIF:FILT:ALPH 0.5 SPEC:DIF:FILT:ALPH?</pre>
Notes	You must be in the IQ Analyzer (Basic) mode to use this command. Use INSTRUMENT:SElect to set the mode.
Dependencies	This feature is only available when Option DP2, B40, or wider IF Bandwidth option is installed.
Preset	0.2
State Saved	Saved in instrument state.
Min	0.01
Max	1.00
Backwards	[:SENSe] :SPEctrum:WBIF:FILTer:ALPHa

Compatibility SCPI

Modified at S/W Revision A.13.00

FFT Window

Opens a menu that enables you to choose one of the available FFT filtering windows.

Key Path	Meas Setup, Advanced
Mode	BASIC
Remote Command	[:SENSe] :SPECTrum:FFT:WINDow[:TYPE] FLATtop UNIFORM HANNing HAMMING GAUSSian BLACKman BH4Tap KB70 KB90 KB110 [:SENSe] :SPECTrum:FFT:WINDow[:TYPE] ?
Example	SPEC:FFT:WIND KB90 SPEC:FFT:WIND?
Notes	This selection affects the acquisition point quantity and the FFT size, based on the resolution bandwidth selected. You must be in the IQ Analyzer (Basic) mode to use this command. Use INSTRUMENT:SElect to set the mode.
Preset	FLATtop
State Saved	Saved in instrument state.
Range	Flat Top (High AmptdAcc) Uniform Hanning Hamming Gaussian (Alpha3.5) Blackman Blackman-Harris K-B 70 dB (Kaiser-Bessel) K-B 90 dB (Kaiser-Bessel) K-B 110 dB (Kaiser-Bessel)
Initial S/W Revision	Prior to A.02.00

FFT Size

Opens a menu that enables you to set the FFT or window length parameters.

Key Path	Meas Setup, Advanced
Initial S/W Revision	Prior to A.02.00

Length Ctrl

Length Ctrl (Man) enables control of the FFT window or length settings. Press Length Ctrl (Auto) to disable the FFT window or length settings. This setting is directly coupled to the Res BW as follows: Enabling Length Ctrl disables the Res BW, while disabling Length Ctrl allows Res BW control.

Key Path	Meas Setup, Advanced, FFT Size
Mode	BASIC
Remote Command	[:SENSe] :SPECTrum:FFT:LENGth:AUTO ON OFF 1 0

	<code>[:SENSe] :SPECTrum:FFT:LENGth:AUTO?</code>
Example	<code>SPEC:FFT:LENG:AUTO 0</code> <code>SPEC:FFT:LENG:AUTO?</code>
Notes	You must be in the IQ Analyzer (Basic) mode to use this command. Use <code>INSTRument:SElect</code> to set the mode.
Preset	ON
State Saved	Saved in instrument state.
Range	Auto Man
Initial S/W Revision	Prior to A.02.00

Min Pnts/RBW

Sets the minimum number of data points that are used inside the resolution bandwidth. The value is ignored if the length control is set to manual. This is an advanced control that normally does not need to be changed.

Key Path	Meas Setup, Advanced, FFT Size
Mode	BASIC
Remote Command	<code>[:SENSe] :SPECTrum:FFT:RBWPoints <real></code> <code>[:SENSe] :SPECTrum:FFT:RBWPoints?</code>
Example	<code>SPEC:FFT:RBWP 0.5</code> <code>SPEC:FFT:RBWP?</code>
Notes	You must be in the IQ Analyzer (Basic) mode to use this command. Use <code>INSTRument:SElect</code> to set the mode.
Preset	3.1
State Saved	Saved in instrument state.
Min	0.1
Max	100
Initial S/W Revision	Prior to A.02.00

Window Length

Sets the FFT window length. This value is only used if the length control is set to manual. This is an advanced control that normally does not need to be changed.

The “points” is the number of points for IQ pairs. For example, if the Window Length is set to 10, it means the window length is for 10 I and 10 Q points. Not 5 I and 5 Q points.

Key Path	Meas Setup, Advanced, FFT Size
Mode	BASIC
Remote Command	<code>[:SENSe] :SPECTrum:FFT:WINDow:LENGth <integer></code>

	<code>[:SENSe] :SPECTrum:FFT:WINDow:LENGth?</code>
Example	<code>SPEC:FFT:WIND:LENG 100</code> <code>SPEC:FFT:WIND:LENG?</code>
Notes	You must be in the IQ Analyzer (Basic) mode to use this command. Use INSTRUMENT:SElect to set the mode.
Dependencies	Grayed out when Length Ctrl is set to Man.
Preset	1694
State Saved	Saved in instrument state.
Min	8
Max	1048576
Initial S/W Revision	Prior to A.02.00

FFT Length

Enables you to set the FFT length. This value is only used if the length control is set to manual. The value must be greater than or equal to the window length value. Any amount greater than the window length is implemented by zero padding. This is an advanced control that normally does not need to be changed.

The “points” is the number of points for IQ pairs. For example, if the Window Length is set to 10, it means the window length is for 10 I and 10 Q points. Not 5 I and 5 Q points.

Key Path	Meas Setup, Advanced, FFT Size
Mode	BASIC
Remote Command	<code>[:SENSe] :SPECTrum:FFT:LENGth <integer></code> <code>[:SENSe] :SPECTrum:FFT:LENGth?</code>
Example	<code>SPEC:FFT:LENG 566</code> <code>SPEC:FFT:LENG?</code>
Notes	You must be in the IQ Analyzer (Basic) mode to use this command. Use INSTRUMENT:SElect to set the mode.
Dependencies	Grayed out when Length Ctrl is set to Man.
Preset	2048
State Saved	Saved in instrument state.
Min	8
Max	131072
Initial S/W Revision	Prior to A.02.00

Meas Preset

Returns all measurement local parameters to the factory default values.

8 Complex Spectrum Measurement
Meas Setup

Key Path	Meas Setup
Mode	BASIC
Remote Command	:CONFigure:SPEctrum
Example	CONF:SPEC
Notes	You must be in the IQ Analyzer (Basic) mode to use this command. Use INSTRument:SElect to set the mode.
Initial S/W Revision	Prior to A.02.00

Mode

See "Mode" on page 142

Mode Preset

Returns the active mode to a known state.

Mode Preset does the following for the currently active mode:

- Aborts the currently running measurement.
- Brings up the default menu for the mode, with no active function.
- Sets measurement Global settings to their preset values for the active mode only.
- Activates the default measurement.
- Brings up the default menu for the mode.
- Clears the input and output buffers.
- Sets Status Byte to 0.

Mode Preset does not:

- Cause a mode switch
- Affect mode persistent settings
- Affect system settings
- See "[How-To Preset](#)" on page 313 for more information.

Key Path	Front-panel key
Remote Command	:SYSTem:PRESet
Example	:SYST:PRES
Notes	*RST is preferred over :SYST : PRES for remote operation. *RST does a Mode Preset, as done by the :SYST:PRES command, and it sets the measurement mode to Single measurement rather than Continuous for optimal remote control throughput. Clears all pending OPC bits. The Status Byte is set to 0.
Couplings	A Mode Preset aborts the currently running measurement, activates the default measurement, and gets the mode to a consistent state with all of the default couplings set.
Backwards Compatibility Notes	In the X-Series, the legacy "Factory Preset" has been replaced with Mode Preset, which only presets the currently active mode, not the entire instrument. In the X-Series, the way to preset the entire instrument is by using System, Restore System Defaults All, which behaves essentially the same way as restore System Defaults does on ESA and PSA. There is also no "Preset Type" as there is on the PSA. There is a green Mode Preset front-panel key that does a Mode Preset and a white-with-green-letters User Preset front-panel key that does a User Preset. The old PRESet:TYPE command is ignored (without generating an error), and SYST:PRES without a parameter does a Mode Preset, which should cover most backward code compatibility issues. The settings and correction data under the Input/Output front-panel key (examples: Input Z Corr, Ext Amp Gain, etc.) are no longer part of any Mode, so they will not be preset by a Mode Preset. They are preset using Restore Input/Output Defaults, Restore System Defaults All. Note that because User Preset does a Recall State, and all of these settings are saved in State, they ARE recalled when using

	User Preset.
Initial S/W Revision	Prior to A.02.00

How-To Preset

The table below shows all possible presets, their corresponding SCPI commands and front-panel access (key paths). Instrument settings depend on the current measurement context. Some settings are local to the current measurement, some are global (common) across all the measurements in the current mode, and some are global to all the available modes. In a similar way, restoring the settings to their preset state can be done within the different contexts.

Auto Couple - is a measurement local key. It sets all Auto/Man parameter couplings in the measurement to Auto. Any Auto/Man selection that is local to other measurements in the mode will not be affected.

Meas Preset - is a measurement local key. Meas Preset resets all the variables local to the current measurement except the persistent ones.

Mode Preset - resets all the current mode's measurement local and measurement global variables except the persistent ones.

Restore Mode Defaults - resets ALL the Mode variables (and all the Meas global and Meas local variables), including the persistent ones.

Type Of Preset	SCPI Command	Front Panel Access
Auto Couple	:COUPlE ALL	Auto Couple front-panel key
Meas Preset	:CONFigure:<Measurement>	Meas Setup Menu
Mode Preset	:SYSTem:PRESet	Mode Preset (green key)
Restore Mode Defaults	:INSTrument:DEFault	Mode Setup Menu
Restore All Mode Defaults	:SYSTem:DEFault MODEs	System Menu; Restore System Default Menu
*RST	*RST	not possible (Mode Preset with Single)
Restore Input/Output Defaults	:SYSTem:DEFault INPut	System Menu; Restore System Default Menu
Restore Power On Defaults	:SYSTem:DEFault PON	System Menu; Restore System Default Menu
Restore Alignment Defaults	:SYSTem:DEFault ALIGn	System Menu; Restore System Default Menu
Restore Miscellaneous Defaults	:SYSTem:DEFault MISC	System Menu; Restore System Default Menu
Restore All System Defaults	:SYSTem:DEFault [ALL] :SYSTem:PRESet:PERSistent	System Menu; Restore System Default Menu
User Preset	:SYSTem:PRESet:USER	User Preset Menu
User Preset All Modes	:SYSTem:PRESet:USER:ALL	User Preset Menu

8 Complex Spectrum Measurement
Mode Preset

Power On Mode Preset	:SYSTem:PON:TYPE MODE	System Menu
Power On User Preset	:SYSTem:PON:TYPE USER	System Menu
Power On Last State	:SYSTem:PON:TYPE LAST	System Menu

Mode Setup

See ["Mode Setup" on page 158](#)

Peak Search

Pressing the Peak Search key displays the Peak Search menu and places the selected marker on the trace point with the maximum y-axis value for that marker's trace. The Peak Search features allow you to define specific search criteria to determine which signals can be considered peaks, excluding unwanted signals from the search.

See "[More Information](#)" on page 316

Key Path	Front panel key
Mode	BASIC
Remote Command	:CALCulate:SPECTrum:MARKer[1] 2 ... 12:MAXimum
Example	CALC:SPEC:MARK2:MAX SYST:ERR? can be used to query the errors to determine if a peak is found. The message "No peak found" will be returned after an unsuccessful search.
Initial S/W Revision	Prior to A.02.00

More Information

The behavior of a Peak Search is dependent on settings under the Peak Criteria softkey on the second page of the menu. If **Same as "Next Peak" Criteria** is selected, and either **Pk Excursion** or **Pk Threshold** are on, a signal must meet those criteria to be considered a peak. If no valid peak is found, a "No peak found" message is generated and the marker is not moved. When **Highest Peak** is on, or both **Pk Excursion** and **Pk Threshold** are off, the marker is always placed at the point on the trace with the maximum y-axis value, even if that point is on the very edge of the trace.

Pressing Peak Search with the selected marker off causes the selected marker to be set to **Normal** at the center of the screen, then a peak search is immediately performed.

Pressing the front panel Peak Search key always does a peak search. Occasionally, you may need to get to the Peak Search menu key functions without doing a peak search. You can do this by first accessing the Peak Search menu. Then go to the other menus that you need to access. Finally, you can get back to the Peak Search key menu by using the front panel Return key and pressing it as many times as required to navigate back through the previously accessed menus until you get back to the Peak Search menu.

Next Peak

Pressing Next Peak moves the selected marker to the peak that has the next highest amplitude less than the marker's current value. Only peaks which meet all enabled peak criteria are considered. If there is no valid peak lower than the current marker position, a "No peak found" message is generated and the marker is not moved.

If the selected marker was off, then it is turned on as a normal marker and a peak search is performed.

Key Path	Peak Search
Mode	BASIC
Remote Command	:CALCulate:SPECTrum:MARKer[1] 2 ... 12:MAXimum:NEXT

Example	CALC:SPEC:MARK:MAX:NEXT
Initial S/W Revision	Prior to A.02.00

Next Pk Right

Pressing Next Pk Right moves the selected marker to the nearest peak right of the current marker which meets all enabled peak criteria. If there is no valid peak to the right of the current marker position, a “No peak found” message is generated and the marker is not moved.

If the selected marker was off, then it is turned on as a normal marker and a peak search is performed.

Key Path	Peak Search
Remote Command	:CALCulate:SPECTrum:MARKer[1] 2 ... 12:MAXimum:RIGHT
Example	CALC:SPEC:MARK2:MAX:RIGH Selects marker 2 and moves it to the next peak to the right of the current marker position.
State Saved	Not part of saved state

Next Pk Left

Pressing Next Pk Left moves the selected marker to the nearest peak left of the current marker which meets all enabled peak criteria. If there is no valid peak to the left of the current marker position, a “No peak found” message is generated and the marker is not moved.

If the selected marker was off, then it is turned on as a normal marker and a peak search is performed.

Key Path	Peak Search
Remote Command	:CALCulate:SPECTrum:MARKer[1] 2 ... 12:MAXimum:LEFT
Example	CALC:SPEC:MARK2:MAX:LEFT Selects marker 2 and moves it to the next peak to the left of the current marker position.
State Saved	Not part of saved state

Marker Delta

Performs the same function as the Delta 1-of-N selection key in the Marker menu. Basically, this sets the control mode for the selected marker to Delta mode. See the Marker section for details of delta markers. The key is duplicated here in the Peak Search Menu to allow you to conveniently perform a peak search and change the marker’s control mode to Delta without having to access two separate menus.

Key Path	Peak Search or Marker
Notes	Whenever the selected marker is in Delta mode and you are in the Peak Search menu, the Marker Delta key should be highlighted and the active function for setting its delta value turned on.
Initial S/W Revision	Prior to A.02.00

Mkr -> CF

Sets the center frequency to the frequency of the selected marker. The marker stays at this frequency, so it moves to the center of the display.

Key Path	Marker ->
Mode	BASIC
Remote Command	:CALCulate:SPECTrum:MARKer[1 2 ... 12[:SET]:CENTer
Example	CALC:SPEC:MARK4:CENT
Notes	In the delta marker mode, this function sets the center frequency to the x-axis value of the delta marker. If the currently selected marker is not on when this key is pressed, it is turned on at the center of the screen as a normal type marker. You must be in the IQ Analyzer (Basic) mode to use this command. Use INSTRument:SElect to set the mode.
Dependencies	This key is not available (grayed out) when the selected marker is not on the spectrum trace.
Initial S/W Revision	Prior to A.02.00

Mkr -> Ref Lvl

Sets the reference level to the amplitude value of the selected marker, moving the marked point to the reference level (top line of the graticule).

Key Path	Marker ->
Mode	BASIC
Remote Command	:CALCulate:SPECTrum:MARKer[1 2 ... 12[:SET]:RLEVel
Example	CALC:SPEC:MARK4:RLEV
Notes	Make the Marker Y value to the display reference value. If the currently selected marker is not on when this key is pressed, it is turned on at the center of the screen as a normal type marker, and its amplitude applied to the reference value. You must be in the IQ Analyzer (Basic) mode to use this command. Use INSTRument:SElect to set the mode.
Initial S/W Revision	Prior to A.02.00

Peak Criteria

Pressing this key opens the Peak Criteria menu and allows you to adjust the Pk Threshold and Pk Excursion parameters used for peak search functions

For a signal to be identified as a peak it must meet certain criteria. Signals in the negative frequency range and signals very close to 0 Hz are ignored. If either the peak excursion or peak threshold functions are on, then the signal must satisfy those criteria before being identified as a peak. (Note that this does not apply when the input is base band I/Q)

When peak excursion and peak threshold are both off:

- **Peak Search, Continuous Peak Search**, and maximum part of **Pk-Pk Search** will search the trace for the point with the highest y-axis value which does not violate the LO feedthrough rules. A rising and falling slope are not required for these three peak search functions.
- The remaining search functions **Next Peak, Next Pk Right**, etc. will only consider trace points which have a rising and falling slope on the left and right respectively.

Key Path	Peak Search
Initial S/W Revision	Prior to A.09.00

“Peak Search” Criteria

This menu lets you decide what kind of search you want to do when the Peak Search key is pressed (or the equivalent SCPI command sent).

Note that there are two “types” of peak search functions. One type is the “Peak Search” type, the other type is the “Next Peak” type. “Next Peak” searches (for example, Next Peak, Next Pk Left, Next Pk Right) are always checked using the Excursion and Threshold criteria as long as these criteria are On. The “Peak Search” type of search, simply finds the highest point on the trace. However you can change the “Peak Search” type of search so that it also uses the Excursion and Threshold criteria. This allows you to find the Maximum point on the trace that also obeys the Excursion and/or Threshold criteria.

When **Highest Peak** is selected, pressing **Peak Search** simply finds the highest peak on the marker’s trace. If **Same as “Next Peak” Criteria** is selected, then the search is also forced to consider the Excursion and Threshold found under the “**Next Peak” Criteria** menu.

Key Path	Peak Search, Peak Criteria
Remote Command	:CALCulate:SPECTrum:MARKer:PEAK:SEARch:MODE MAXimum PARAmeter :CALCulate:SPECTrum:MARKer:PEAK:SEARch:MODE?
Notes	MAXimum corresponds to the Highest Peak setting PARAmeter corresponds to the Same as “Next Peak” Criteria setting
Preset	MAXimum
State Saved	Saved in instrument state.
Readback line	Current state
Initial S/W Revision	Prior to A.09.00

Highest Peak

When this key is selected, pressing the Peak Search key or issuing the equivalent SCPI command finds the maximum point on the trace, subject to the peak-search qualifications. This also affects the Peak Search half of Pk-Pk search and the Continuous Peak Search.

Key Path	Peak Search, Peak Criteria, “Peak Search” Criteria
----------	---

Example	CALC:SPECTrum:MARK:PEAK:SEAR:MODE MAX
Readback	Highest Peak
Initial S/W Revision	Prior to A.09.00

Same as “Next Peak” Criteria

When this key is selected, pressing the Peak Search key or issuing the equivalent SCPI command finds the maximum point on the trace, but subject to the Excursion and Threshold set under the Next Peak Criteria menu. The search is, of course, also subject to the peak-search qualifications. This also affects the Peak Search half of Pk-Pk search and the Continuous Peak Search.

Key Path	Peak Search, Peak Criteria, “Peak Search” Criteria
Example	CALC:SPECTrum:MARK:PEAK:SEAR:MODE PAR
Readback	Use Excurs & Thr
Initial S/W Revision	Prior to A.09.00

“Next Peak” Criteria

This key opens up a menu which allows you to independently set the Peak Excursion and Peak Threshold and turn them on and off.

Key Path	Peak Search, Peak Criteria
Initial S/W Revision	Prior to A.09.00

Pk Excursion

Turns the peak excursion requirement on/off and sets the excursion value. The value defines the minimum amplitude variation (rise and fall) required for a signal to be identified as peak. For example, if a value of 6 dB is selected, peak search functions like the marker Next Pk Right function move only to peaks that rise and fall 6 dB or more.

When both Pk Excursion and Pk Threshold are on, a signal must rise above the Pk Threshold value by at least the **Peak Excursion** value and then fall back from its local maximum by at least the **Peak Excursion** value to be considered a peak.

NOTE In the event that a sequence of trace points with precisely the same values represents the maximum, the leftmost point is found.

See "[More Information](#)" on page 321.

Key Path	Peak Search, Peak Criteria, “Next Peak” Criteria
Remote Command	:CALCulate:SPECTrum:MARKer:PEAK:EXCursion <rel_ampl>

	:CALCulate:SPECTrum:MARKer:PEAK:EXCursion?
	:CALCulate:SPECTrum:MARKer:PEAK:EXCursion:STATe OFF ON 0 1
	:CALCulate:SPECTrum:MARKer:PEAK:EXCursion:STATe?
Example	:CALC:SPECTrum:MARK:PEAK:EXC:STAT ON :CALC:SPECTrum:MARK:PEAK:EXC 30 DB sets the minimum peak excursion requirement to 30 dB
Couplings	Whenever you adjust the value of Pk Excursion (with the knob, step keys, or by completing a numeric entry), and Peak Threshold is turned ON, the Peak Threshold Line and the Peak Excursion Region are displayed
Preset	6.0 dB ON
Preset	6.0 dB ON
State Saved	Saved in instrument state
Min	0.0 dB
Max	100.0 dB
Initial S/W Revision	Prior to A.09.00

More Information

If two signals are very close together and the peak excursion and threshold criteria are met at the outside edges of the combined signals, this function finds the highest of these two signals as a peak (or next peak). However, if a signal appears near the edge of the screen such that the full extent of either the rising or falling edge cannot be determined, and the portion that is on screen does not meet the excursion criteria, then the signal cannot be identified as a peak.

When measuring signals near the noise floor, you can reduce the excursion value even further to make these signals recognizable. To prevent the marker from identifying noise as signals, reduce the noise floor variations to a value less than the peak-excursion value by increasing the averaging count.

Pk Threshold

Turns the peak threshold requirement on/off and sets the threshold value. The peak threshold value defines the minimum signal level (or min threshold) that the peak identification algorithm uses to recognize a peak.

When both Pk Excursion and Pk Threshold are on, a signal must rise above the Pk Threshold value by at least the **Peak Excursion** value and then fall back from its local maximum by at least the **Peak Excursion** value to be considered a peak.

For example, if a threshold value of -90 dBm is selected, the peak search algorithm will only consider signals with amplitude greater than the -90 dBm threshold. If a threshold value of -90 dBm is selected, and **Peak Excursion** is **On** and set to 6 dB, the peak search algorithm will only consider signals with amplitude greater than the -90 dBm threshold which rise 6 dB above the threshold and then fall back to the threshold.

Key Path	Peak Search, Peak Criteria, "Next Peak Criteria"
Remote Command	:CALCulate:SPECTrum:MARKer:PEAK:THReshold <ampl> :CALCulate:SPECTrum:MARKer:PEAK:THReshold? :CALCulate:SPECTrum:MARKer:PEAK:THReshold:STATE OFF ON 0 1 :CALCulate:SPECTrum:MARKer:PEAK:THReshold:STATE?
Example	CALC:SPECTrum : MARK:PEAK:THR:STAT ON turns on the threshold criterion. CALC:SPECTrum : MARK:PEAK:THR -60 dBm sets the threshold to -60 dBm.
Preset	-90.0 dBm ON
State Saved	Saved in instrument state.
Min	The current Ref Level - 200 dB.
Max	The current Ref Level.
Initial S/W Revision	Prior to A.09.00

Pk Threshold Line

Turns the peak threshold line on or off. Preset state is off. No equivalent SCPI command.

See ["More Information" on page 322](#).

Dependencies	If Peak Threshold is Off and the Peak Threshold line is turned on, it should turn on Peak Threshold.
Initial S/W Revision	Prior to A.09.00

More Information

The Peak Threshold line is green and has the value of the peak threshold (for example, "-20.3 dBm") written above its right side above the line itself. If Peak Excursion is ON it shows on the left side as a region above the Peak Threshold line. As with all such lines (Display Line, Trigger Level line, etc.) it is drawn on top of all traces.

TODO: Replace with Complex Spectrum screen shot

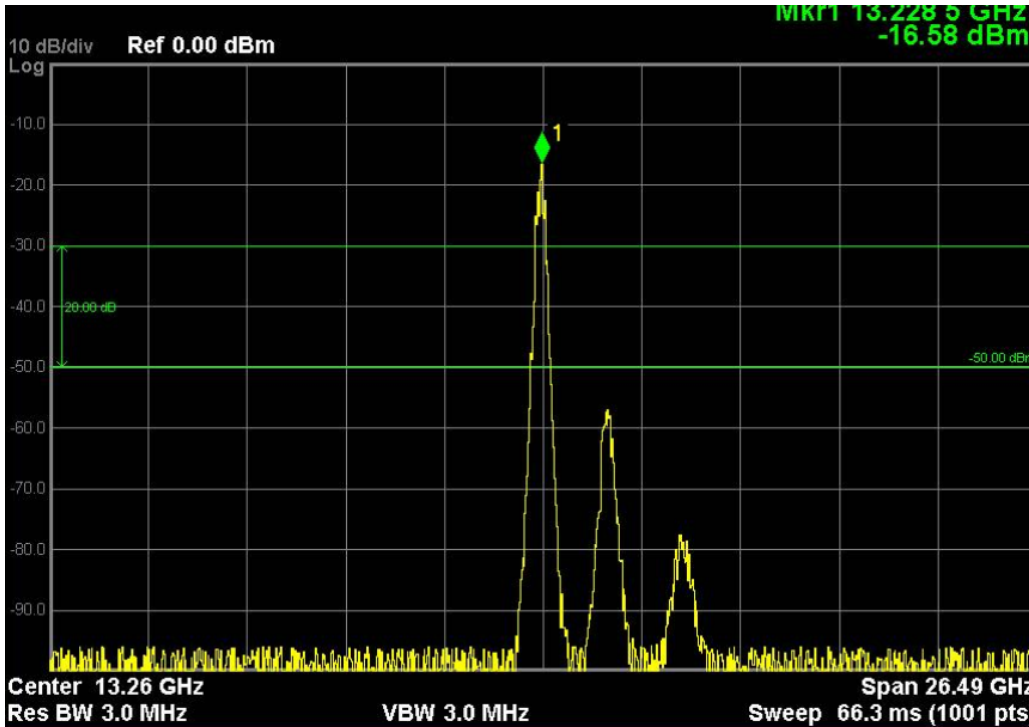

This function is automatically set to ON (thus turning on the Peak Threshold line) whenever the value of Peak Threshold or Peak Excursion becomes the active function, unless Peak Threshold is OFF. It is automatically set to OFF whenever Peak Threshold is set to OFF. Manually turning it ON automatically turns on Pk Threshold.

The Peak Excursion part is on whenever the Pk Threshold part is on, unless Peak Excursion is OFF.

Continuous Peak Search

Turns Continuous Peak Search on or off. When Continuous Peak Search is on, a peak search is automatically performed for the selected marker after each sweep. The rules for finding the peak are exactly the same as for **Peak Search** including the use of the peak criteria rules. If no valid peak is found, a “No peak found” message is generated after each sweep.

Key Path	Peak Search
Remote Command	:CALCulate:SPECTrum:MARKer[1] 2 ... 12:CPSearch[:STATe] ON OFF 1 0 :CALCulate:SPECTrum:MARKer[1] 2 ... 12:CPSearch[:STATe]?
Example	CALC:SPEC:MARK:CPS ON Turns on Continuous Peak Search.
Notes	Sending this command selects the subopcoded marker
Preset	Mode Preset
State Saved	Saved in instrument state.
Status Bits/OPC dependencies	The Measuring bit should remain set while this command is operating and should not go false until the marker position has been updated.
Initial S/W Revision	Prior to A.09.00

More Information

When Continuous Peak Search is turned on a peak search is immediately performed and then is repeated after each sweep. If Continuous Peak Search is turned on with the selected marker off, the selected marker is set to **Normal** at the center of the screen, and then a peak search is immediately performed and subsequently repeated after each sweep.

When in Continuous Peak Search, *OPC will not return true, nor will READ or MEASure return any data, until the sweep is complete and the marker has been re-peaked. Note further that if the analyzer is in a measurement such as averaging, and Continuous Peak Search is on, the entire measurement will be allowed to complete (i.e., all the averages taken up to the average number) before the repeak takes place, and only THEN will *OPC go true and READ or MEASure return data.

Note that this function is not the “Continuous Peak” function found in some other instruments. That function was designed to track the signal; this function simply does a Peak Search after each sweep.

When Continuous Peak Search is turned on for a marker, a little “hat” is placed above the marker.



Pk-Pk Search

Finds and displays the amplitude and frequency (or time, if the markers are on the I or Q trace) differences between the highest and lowest y-axis value. It places the selected marker on the minimum value on its selected trace. And it places that marker's reference marker on the peak of its selected trace.

The rules for finding the maximum peak are exactly the same as for **Peak Search** including the use of the peak criteria rules. However, the minimum trace value is not required to meet any criteria other than being the minimum y-axis value in the trace.

If the selected marker is off, a delta type marker is turned on and the peak-to-peak search is done. If the selected marker is on, but it is not a delta marker, then it is changed to delta which turns on the reference marker if needed, and then it performs the peak-to-peak function.

Key Path	Peak Search
Remote Command	:CALCulate:SPECTrum:MARKer[1] 2 ... 12:PTPeak
Example	CALC:SPEC:MARK:PTP

	CALC:SPEC:MARK:Y? queries the delta amplitude value for marker 1.
Notes	Turns on the Marker Δ active function.
Notes	Sending this command selects the subcoded marker.
Dependencies	Pk-Pk Search is grayed out when Coupled Markers is on.
Couplings	The selected marker becomes a delta marker if not already in delta mode.
State Saved	Not part of saved state.
Initial S/W Revision	Prior to A.09.00

Min Search

Moves the selected marker to the minimum y-axis value on the current trace. Minimum (negative) peak searches do not have to meet the peak search criteria. It just looks for the lowest y-axis value. If the selected marker is Off, it is turned on before the minimum search is performed.

Key Path	Peak Search
Remote Command	:CALCulate:SPECTrum:MARKer[1] 2 ... 12:MINimum
Example	CALC:SPEC:MARK:MIN selects marker 1 and moves it to the minimum amplitude value.
Notes	Sending this command selects the subcoded marker.
State Saved	Not part of saved state.
Initial S/W Revision	Prior to A.09.00

8 Complex Spectrum Measurement
Print

Print

See ["Print " on page 165](#)

Quick Save

The Quick Save front-panel key repeats the most recent save that was performed from the Save menu, with the following exceptions:

- Register saves are not remembered as Saves for the purpose of the Quick Save function
- If the current measurement does not support the last non-register save that was performed, an informational message is generated, “File type not supported for this measurement”

Quick Save repeats the last type of qualified save (that is, a save qualified by the above criteria) in the last save directory by creating a unique filename using the Auto File Naming algorithm described below.

If Quick Save is pressed after startup and before any qualified Save has been performed, the Quick Save function performs a Screen Image save using the current settings for Screen Image saves (current theme, current directory), which then becomes the “last save” for the purpose of subsequent Quick Saves.

The Auto File Naming feature automatically generates a file name for use when saving a file. The filename consists of a prefix and suffix separated by a dot, as is standard for the Windows® file system. A default prefix exists for each of the available file types:

Type	Default Prefix	Menu
State	State_	(Save/Recall)
Trace + State	State_	(Save/Recall)
Screen	Screen_	(Save/Recall)
Amplitude Corrections	Ampcor_	(Import/Export)
Traces	Trace_	(Import/Export)
Limit Lines	LLine_	(Import/Export)
Measurement Result	MeasR_	(Import/Export)
Capture Buffer	CapBuf_	(Import/Export)

A four digit number is appended to the prefix to create a unique file name. The numbering sequence starts at 0000 within each Mode for each file type and updates incrementally to 9999, then wraps to 0000 again. It remembers where it was through a Mode Preset and when leaving and returning to the Mode. It is reset by Restore Misc Defaults and Restore System Defaults and subsequent running of the instrument application. So, for example, the first auto file name generated for State files is State_0000.state. The next is State_0001, and so forth.

One of the key features of Auto File Name is that we guarantee that the Auto File Name will never conflict with an existing file. The algorithm looks for the next available number. If it gets to 9999, then it looks for holes. If it find no holes, that is no more numbers are available, it gives an error.

For example, if when we get to State_0010.state there is already a State_0010.state file in the current directory, it advances the counter to State_0011.state to ensure that no conflict will exist (and then it verifies that State_0011.state also does not exist in the current directory and advances again if it does, and so forth).

If you enter a file name for a given file type, then the prefix becomes the filename you entered instead of the default prefix, followed by an underscore. The last four letters (the suffix) are the 4-digit number.

For example, if you save a measurement results file as “fred.csv”, then the next auto file name chosen for a measurement results save will be fred_0000.csv.

NOTE

Although 0000 is used in the example above, the number that is used is actually the current number in the Meas Results sequence, that is, the number that would have been used if you had not entered your own file name.

NOTE

If the filename you entered ends with _dddd, where d=any number, making it look just like an auto file name, then the next auto file name picks up where you left off with the suffix being dddd + 1.

Key Path	Front-panel key
Notes	No remote command for this key specifically.
Initial S/W Revision	Prior to A.02.00

Recall

The **Recall** menu lets you choose what you want to recall, and where you want to recall it from. Among the types of files you can recall are **States and Traces**. In addition, an **Import (Data)** option lets you recall a number of data types stored in CSV files (as used by Excel and other spreadsheet programs).

The default paths for Recall are data type dependent and are the same as for the Save key.

Key Path	Front-panel key
Notes	<p>No remote command for this key specifically, but the :MMEM:LOAD command is available for specific file types. An example is :MMEM:LOAD:STATe <filename>.</p> <p>If you try to recall a State file for a mode that is not licensed or not available in the instrument, an error message will occur and the state will not change.</p>
Backwards Compatibility Notes	<p>In legacy analyzers, it was possible to load a state without affecting the trace data, limit lines or correction data. Similarly (since User Preset is actually loading a state), it was possible to do a User Preset without affecting the trace data, limit lines or correction data.</p> <p>In the X-Series, “state” always includes all of this data; so whenever state is loaded, all of the traces, limit lines and corrections are affected. Although this differs from previous behavior, it is desirable behavior, and should not cause adverse issues for users.</p>
Backwards Compatibility Notes	<p>Recall for the X-Series supports backward compatibility in the sense that you can recall a state file from any X-Series model number and any version of X-Series software. This is only possible if part of the recalling process goes through a limiting step after recalling the mode settings, at least for settings that may vary with version number, model number, option and license differences. If you try to recall a state file onto an instrument with less capability than what was available on the instrument during the save, the recall will ignore the state it doesn't support and it will limit the recalled setting to what it allows.</p> <p>Example: if the saved state includes preamp ON, but the recalling instrument does not have a preamp; the preamp is limited to OFF. Conversely, if you save a state without a preamp, the preamp is OFF in the state file. When this saved file is recalled on an instrument with a licensed preamp, the preamp is changed to OFF. Another example is if the saved state has center frequency set to 20 GHz, but the instrument recalling the saved state is a different model and only supports 13.5 GHz. In this case, the center frequency is limited along with any other frequency based settings. Since the center frequency can't be preserved in this case, the recall limiting tries to at least preserve span to keep the measurement setup as intact as possible.</p> <p>It may be appropriate to issue a warning if the state is limited on the recall; warnings do not go out to SCPI so this would only affect the manual user.</p> <p>Note that there is no state file compatibility outside of the X-Series. For example, you cannot recall a state file from ESA or PSA.</p>
Initial S/W Revision	Prior to A.02.00

State

The **Recall State** menu lets you choose a register or file from which to recall the state.

The content of a state file includes all of the settings and data required to return the analyzer as closely as possible to the Mode it was in, with the exact settings that were in place, when the save occurred. The Mode settings in each state file include the settings that are affected by Mode Preset, as well as the

additional settings affected by Restore Mode Defaults; all of the Mode's settings. In addition, all of the settings of the **Input/Output** system are included, even though they are outside of the Mode's state, because they are needed to restore the complete setup. Persistent System settings (for example, GPIB address) are not affected by either a Mode Preset or Restore Mode Defaults, nor are they included in a saved State file.

Since each state file is only for one Mode, the settings for other Modes are unaffected when it is loaded. **Recall State** will cause a mode switch if the state being recalled is not from the current active mode.

After the recall completes, the message "File <filename> recalled" or "Recalled State Register <register number>" is displayed.

For rapid recalls, the State menu lists 16 registers that you can choose from to recall. Pressing a Register key initiates the recall. You can also select a file from which to recall.

The default path for all State Files is:

My Documents\<<mode name>\state

where <mode name> is the parameter used to select the mode with the INST:SEL command (for example, SA for the Spectrum Analyzer).

See "[More Information](#)" on page 331.

Key Path	Recall
Mode	All
Remote Command	:MMEMory:LOAD:STATe <filename>
Example	:MMEM:LOAD:STAT "myState.state" This recalls the file myState.state on the default path
Example	MMEM:LOAD:STAT "MyStateFile.state" This loads the state file data (on the default file directory path) into the instrument state.
Notes	<p>When you pick a file to recall, the analyzer first verifies that the file is recallable in the current instrument by checking the software version and model number of the instrument. If everything matches, a full recall proceeds by aborting the currently running measurement, clearing any pending operations, and then loading the State from the saved state file. You can open state files from any mode, so recalling a State file switches to the mode that was active when the save occurred. After switching to the mode of the saved state file, mode settings and data (if any for the mode) are loaded with values from the saved file. The saved measurement of the mode becomes the newly active measurement and the data relevant to the measurement (if there is any) is recalled.</p> <ul style="list-style-type: none"> • If there is a mismatch between file version or model number or instrument version or model number, the recall function tries to recall as much as possible and returns a warning message. It may limit settings that differ based on model number, licensing or version number. <p>After recalling the state, the Recall State function does the following:</p> <ul style="list-style-type: none"> • Makes the saved measurement for the mode the active measurement. • Clears the input and output buffers. • Status Byte is set to 0. • Executes a *CLS <p>If the file specified is empty an error is generated. If the specified file does not exist, another error is generated. If there is a mismatch between the file and the proper file type, an error is generated. If</p>

	there is a mismatch between file version or model number or instrument version or model number, a warning is displayed. Then it returns to the State menu and File Open dialog goes away. After the Recall, the analyzer exits the Recall menu and returns to the previous menu.
Backwards Compatibility SCPI	:MMEMory:LOAD:STATe 1,<filename> For backwards compatibility, the above syntax is supported. The "1" is simply ignored.
Initial S/W Revision	Prior to A.02.00

More Information

In measurements that support saving Traces, for example, Swept SA, the Trace data is saved along with the State in the State file. When recalling the State, the Trace data is recalled as well. Traces are recalled exactly as they were stored, including the writing mode and update and display modes. If a Trace was updating and visible when the State was saved, it will come back updating and visible, and its data will be rewritten right away. When you use State to save and recall traces, any trace whose data must be preserved should be placed in View or Blank mode before saving.

The following table describes the Trace Save and Recall possibilities:

You want to recall state and one trace's data, leaving other traces unaffected.	Save Trace+State from 1 trace. Make sure that no other traces are updating (they should all be in View or Blank mode) when the save is performed.	On Recall, specify the trace you want to load the one trace's data into. This trace will load in View. All other traces' data will be unaffected, although their trace mode will be as it was when the state save was performed.
You want to recall all traces	Save Trace+State from ALL traces.	On Recall, all traces will come back in View (or Blank if they were in Blank or Background when saved)
You want all traces to load exactly as they were when saved.	Save State	On recall, all traces' mode and data will be exactly as they were when saved. Any traces that were updating will have their data immediately overwritten.

From File...

When you press "From File", the analyzer brings up a Windows dialog and a menu entitled "File Open." This menu allows you to navigate to the various fields in the Windows dialog without using a keyboard or mouse. The **Tab** and **Arrow** keys can also be used for dialog navigation.

8 Complex Spectrum Measurement Recall

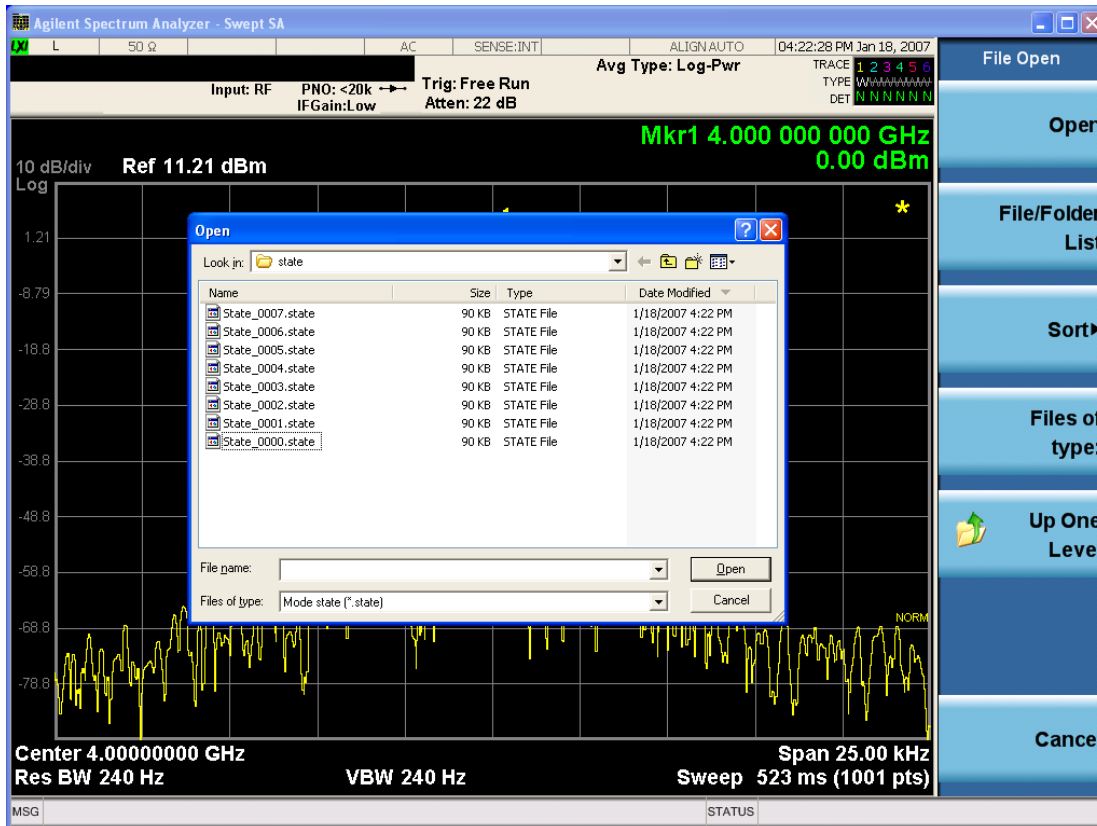

Listed below are the functions of the various fields in the dialog, and the corresponding softkeys:

Open

Performs the recall of the specified file. While the recall is being performed, the floppy icon appears briefly in the Meas bar.

File/Folder List

Enables you to navigate to the center of the dialog that contains the list of files and folders. Once here you can get information about the file and use the tab keys to navigate to the other fields in the dialog, such as Look In.

Look In

The **Look In** field shows the path from which the file will be recalled and allows you to change the path using the up and down arrow keys to navigate to other paths; the Enter key to open a directory; and the Backspace key to go back one directory. The **Look In field** first uses the last path from the Save As dialog **Save In:** path for that same file type. There is no softkey for directly navigating to the Look In field, but you can use the left tab to get here from the File/Folder List.

User specified paths are remembered when you leave and return to a Mode and are reset back to the default using **Restore Mode Defaults**.

Sort

Accesses a menu that enables you to sort the files within the File Open dialog. Only one sorting type can be selected at a time and the sorting happens immediately. The sorting types are **By Date**, **By Name**, **By extension**, and **By Size**.

Files of Type

This field shows the file suffix for the type of file you have selected to recall. For example, if you navigated here while recalling State, "Mode state (*.state)" is in the field. If you navigated here while recalling Trace, ""Mode state (*.trace)" is in the field. If you navigated here while importing a trace data file, "Trace Data (*.csv)" is in the field. For some file types, there is more than one choice in the dropdown menu, which you can select by using the up and down arrow keys and Enter.

Up One Level

This key corresponds to the icon of a folder with the up arrow that is in the tool bar of the dialog. When pressed, it causes the file and folder list to navigate up one level in the directory structure. The Backspace key does the same thing.

Cancel

This key corresponds to the **Cancel** selection in the dialog. It causes the current **Open** request to be cancelled. The ESC key does the same thing.

Key Path	Recall, State
Notes	Brings up the Open dialog for recalling a State Save Type
Initial S/W Revision	Prior to A.02.00

Edit Register Names

You may enter a custom name on any of the Register keys, to help you remember what you are using that state to save. To do this, press the **Edit Register Names** key, choose the register whose name you wish to edit, and then enter the desired label using the Alpha Editor or an external PC keyboard.

The maximum number of characters that can be added is 30. In most cases, 30 characters will fit on two lines of the key.

For more information and the SCPI command, see Edit Register Names under the **Save, State** function.

Key Path	Recall, State
Mode	All
Dependencies	N9060A-7FP or N9060B-2FP license required to edit the register names. When the feature is not licensed, sending the SCPI command generates an error, -221, "Settings conflict;Option not available"
Initial S/W Revision	A.11.00

Register 1 thru Register 16

Selecting any one of these register keys causes the State of the mode from the specified Register to be recalled. Each of the register keys annotates whether it is empty or at what date and time it was last

modified. In addition, you can use the **Edit Register Names** key under **Save, State** to enter custom names for each register.

Registers are shared by all modes, so recalling from any one of the registers will cause a mode switch to the mode that was active when the save to the Register occurred.

Although these 16 registers are the only registers available from the front panel, there are 128 state registers available in the instrument. Registers 17–128 are only available from the SCPI interface, using the *RCL command.

After the recall completes, the message "Register <register number> recalled" appears in the message bar. If you are in the Spectrum Analyzer Mode, and you are recalling a register that was saved in the Spectrum Analyzer Mode, then after the recall, you will still be in the Recall Register menu. If the Recall causes you to switch modes, then after the Recall, you will be in the Frequency menu.

If a requested register is empty an error is generated.

Key Path	Recall, State
Example	*RCL 1
Range	1–16 from front panel, 1–128 from SCPI
Readback	Date and time with seconds resolution are displayed on the key OR A custom name of up to 30 characters entered using the Save, State, Edit Register Names key OR “(empty)” if no prior save operation has been performed to this register.
Initial S/W Revision	Prior to A.02.00
Modified at S/W Revision	Prior to A.11.00

Register 1 thru Register 16

Selecting any one of these register keys causes the State of the mode from the specified Register to be recalled. Each of the register keys annotates whether it is empty or at what date and time it was last modified. In addition, you can use the **Edit Register Names** key under **Save, State** to enter custom names for each register.

Registers are shared by all modes, so recalling from any one of the registers will cause a mode switch to the mode that was active when the save to the Register occurred.

Although these 16 registers are the only registers available from the front panel, there are 128 state registers available in the instrument. Registers 17–128 are only available from the SCPI interface, using the *RCL command.

After the recall completes, the message "Register <register number> recalled" appears in the message bar. If you are in the Spectrum Analyzer Mode, and you are recalling a register that was saved in the Spectrum Analyzer Mode, then after the recall, you will still be in the Recall Register menu. If the Recall causes you to switch modes, then after the Recall, you will be in the Frequency menu.

If a requested register is empty an error is generated.

Key Path	Recall, State
Example	*RCL 1
Range	1–16 from front panel, 1–128 from SCPI
Readback	Date and time with seconds resolution are displayed on the key OR A custom name of up to 30 characters entered using the Save, State,Edit Register Names key OR “(empty)” if no prior save operation has been performed to this register.
Initial S/W Revision	Prior to A.02.00
Modified at S/W Revision	Prior to A.11.00

Sequences

These keys allow you to import a Tab separated or .txt file that will automatically setup all the parameters required for building a Sequence. The parameters will automatically be loaded into the Stated Sequencer.

Once selected, in order to import the selected Sequence Type you must select the Open key in the Source Sequence menu.

Key Path	Recall, Sequences
Mode	All
Remote Command	:MMEMory:LOAD:SEQuences: SLIS ALIS SAALIS "MySequence.txt"
Example	:MMEM:LOAD:SEQ:SLIS "MySequence.txt"
Notes	Available file types are: –CSV (Comma delimited) (*.csv) –Text (Tab delimited) (*.txt)
Initial S/W Revision	A.05.00

Source Sequence

The list of parameters, that configure steps, that makes up a sequence for the Source.

The Source sequence is a sequence of flexible configurable steps that can be set anywhere in the instruments frequency range.

Key Path	Recall, Sequences
Example	:MMEM:LOAD:SEQ:SLIS "MySequence.txt"
Dependencies	Only available in XOBT
Initial S/W Revision	A.05.00

Open...

When you press “Open”, the analyzer brings up a Windows dialog and a menu entitled “**File Open.**” This menu allows you to navigate to the various fields in the Windows dialog without using a keyboard or mouse. The **Tab** and **Arrow** keys can also be used for dialog navigation.

See "[From File...](#)" on page 586 in **Recall, State**, for a full description of this dialog and menu.

Key Path	Recall, Data
Notes	The key location is mode-dependent and will vary. Brings up Open dialog for recalling a <mode specific> Save Type
Initial S/W Revision	Prior to A.02.00

Data (Import)

Importing a data file loads data that was previously saved from the current measurement or from other measurements and/or modes that produce compatible data files. The Import Menu only contains Data Types that are supported by the current measurement.

Since the commonly exported data files are in .csv format, the data can be edited by the user prior to importing. This allows you to export a data file, manipulate the data in Excel (the most common PC Application for manipulating .csv files) and then import it.

Importing Data loads measurement data from the specified file into the specified or default destination, depending on the data type selected. Selecting an Import Data menu key will not actually cause the importing to occur, since the analyzer still needs to know from where to get the data. Pressing the Open key in this menu brings up the Open dialog and Open menu that provides you with the options from where to recall the data. Once a filename has been selected or entered in the Open menu, the recall occurs as soon as the Open button is pressed.

Key Path	Recall
Mode	All
Notes	The menu is built from whatever data types are available for the mode. Some keys will be missing completely, so the key locations in the sub-menu will vary. No SCPI command directly controls the Data Type that this key controls. The Data Type is included in the MMEM:LOAD commands.
Dependencies	If a file type is not used by a certain measurement, it is grayed out for that measurement. The key for a file type will not show at all if there are no measurements in the Mode that support it.
Preset	Is not affected by Preset or shutdown, but is reset during Restore Mode Defaults
Readback	The data type that is currently selected
Initial S/W Revision	Prior to A.02.00

Amplitude Correction

This key selects the Amplitude Corrections as the data type to be imported. When pressed a second time, it brings up the Select Menu, which lets you select the Correction into which the data will be imported.

Amplitude Corrections are fully discussed in the documentation of the Input/Output key, under the Corrections key.

A set of preloaded Corrections files can be found in the directory

/My Documents/ EMC Limits and Ampcor.

When the Amplitude Correction is an Antenna correction and the Antenna Unit in the file is not **None**, the Y Axis Unit setting will change to match the Antenna Unit in the file.

Key Path	Recall
Mode	SA EDGE GSM PN
Remote Command	:MMEMory:LOAD:CORRection 1 2 3 4 5 6 7 8, <filename>
Example	:MMEM:LOAD:CORR 2, "myAmpcor.csv" recalls the Amplitude Correction data from the file myAmpcor.csv in the current directory to the 2nd Amplitude Correction table, and turns on Correction 2. The default path is D:\User_My_Documents\Instrument\My Documents\amplitudeCorrections\
Dependencies	<p>Only the first correction array (Correction 1) supports antenna units. This means that a correction file with an Antenna Unit can only be loaded into the Corrections 1 register. Consequently only for Correction 1 does the dropdown in the Recall dialog include .ant, and if an attempt is made to load a correction file into any other Correction register which DOES contain an antenna unit, a Mass Storage error is generated.</p> <p>Corrections are not supported by all Measurements. If in a Mode in which some Measurements support it, this key will be grayed out in measurements that do not. The key will not show at all if no measurements in the Mode support it.</p> <p>Errors are reported if the file is empty or missing, or if the file type does not match, or if there is a mismatch between the file type and the destination data type. If any of these occur during manual operation, the analyzer returns to the Import Data menu and the File Open dialog goes away.</p> <p>This key does not appear unless you have the proper option installed in your instrument.</p> <p>This command will generate an "Option not available" error unless you have the proper option installed in your instrument.</p>
Couplings	When a correction file is loaded from mass storage, it is automatically turned on (Correction ON) and ApplyCorrections is set to On. This allows you to see its effect, thus confirming the load.
Readback	selected Correction
Backwards Compatibility SCPI	:MMEMory:LOAD:CORRection ANTenna CABLe OTHer USER, <filename> For backwards compatibility, ANTenna maps to 1, CABLe maps to 2, OTHer maps to 3 and USER maps to 4
Initial S/W Revision	A.02.00

Amplitude Correction

These keys let you select which Correction to import the data into. Once selected, the key returns back to the Import Data menu and the selected Correction number is annotated on the key. The next step is to select the Open key in the Import Data menu.

Antenna corrections are a particular kind of Amplitude Corrections – they are distinguished in the corrections file by having the Antenna Unit set to a value other than None. Only Correction 1 supports Antenna Units.

Key Path	Recall, Data, Amplitude Correction
Notes	auto return
Dependencies	Only Correction 1 may be used to load a Correction that contains an Antenna Unit other than None
Preset	Not part of Preset, but is reset to Correction 1 by Restore Input/Output Defaults; survives shutdown.
State Saved	The current Correction number is saved in instrument state
Initial S/W Revision	A.02.00

Open...

When you press “Open”, the analyzer brings up a Windows dialog and a menu entitled “**File Open.**” This menu allows you to navigate to the various fields in the Windows dialog without using a keyboard or mouse. The **Tab** and **Arrow** keys can also be used for dialog navigation.

See "[From File...](#)" on page 586 in **Recall, State**, for a full description of this dialog and menu.

Key Path	Recall, Data
Notes	The key location is mode-dependent and will vary. Brings up Open dialog for recalling a <mode specific> Save Type
Initial S/W Revision	Prior to A.02.00

Restart

The Restart function restarts the current sweep, or measurement, or set of averaged/held sweeps or measurements. If you are Paused, pressing Restart does a Resume.

The Restart function is accessed in several ways:

- Pressing the Restart key
- Sending the remote command INIT:IMMEDIATE
- Sending the remote command INIT:RESTART

See "[More Information](#)" on page 339

Key Path	Front-panel key
Remote Command	:INITiate[:IMMEDIATE] :INITiate:RESTART
Example	:INIT:IMM :INIT:REST
Notes	:INITiate:RESTART and :INITiate:IMMEDIATE perform exactly the same function.
Couplings	Resets average/hold count k. For the first sweep overwrites all active (update=on) traces with new current data. For application modes, it resets other parameters as required by the measurement.
Status Bits/OPC dependencies	This is an Overlapped command. The STATUS:OPERation register bits 0 through 8 are cleared. The STATUS:QUESTIONable register bit 9 (INTEgrity sum) is cleared. The SWEEPING bit is set. The MEASURING bit is set.
Backwards Compatibility Notes	For Spectrum Analysis mode in ESA and PSA, the Restart hardkey and the INITiate:RESTART command restart trace averages (displayed average count reset to 1) for a trace in Clear Write , but did not restart Max Hold and Min Hold . In the X-Series, the Restart hardkey and the INITiate:RESTART command restart not only Trace Average , but MaxHold and MinHold traces as well. For wireless comms modes in ESA and PSA, the Restart hardkey and the INITiate:RESTART command restart every measurement, which includes all traces and numeric results. There is no change to this operation.
Initial S/W Revision	Prior to A.02.00

More Information

The **Restart** function first aborts the current sweep/measurement as quickly as possible. It then resets the sweep and trigger systems, sets up the measurement and initiates a new data measurement sequence with a new data acquisition (sweep) taken once the trigger condition is met.

If the analyzer is in the process of aligning when **Restart** is executed, the alignment finishes before the restart function is performed.

Even when set for Single operation, multiple sweeps may be taken when Restart is pressed (for example, when averaging/holding is on). Thus when we say that **Restart** "restarts a measurement," we may mean:

- It restarts the current sweep
- It restarts the current measurement
- It restarts the current set of sweeps if any trace is in Trace Average, Max Hold or Min Hold
- It restarts the current set of measurements if Averaging, or Max Hold, or Min Hold is on for the measurement
- depending on the current settings.

With **Average/Hold Number** (in **Meas Setup** menu) set to 1, or Averaging off, or no trace in Trace Average or Hold, a single sweep is equivalent to a single measurement. A single sweep is taken after the trigger condition is met; and the analyzer stops sweeping once that sweep has completed. However, with **Average/Hold Number** >1 and at least one trace set to **Trace Average, Max Hold, or Min Hold (SA Measurement)** or **Averaging on (most other measurements)**, multiple sweeps/data acquisitions are taken for a single measurement. The trigger condition must be met prior to each sweep. The sweep is stopped when the average count k equals the number N set for **Average/Hold Number**. A measurement average usually applies to all traces, marker results, and numeric results; but sometimes it only applies to the numeric results.

Once the full set of sweeps has been taken, the analyzer will go to idle state. To take one more sweep without resetting the average count, increment the average count by 1, by pressing the step up key while **Average/Hold Number** is the active function, or sending the remote command `CALC:AVER:TCON UP`.

Save

The **Save** menu lets you choose what you want to save and where you want to save it. Among the types of files you can save are **States**, **Traces**, and **Screen Images**. In addition, an **Export (Data)** option lets you save a number of data types as CSV files for easy import into Excel and other spreadsheet programs.

Key Path	Front-panel key
Mode	All
Notes	No remote command for this key specifically, but the :MMEM:STORe command is available for specific file types. An example is :MMEM:STOR:STATe <filename>.
Initial S/W Revision	Prior to A.02.00

State

The Save State menu lets you choose a register or file for saving the state.

The content of a state file includes all of the settings and data required to return the analyzer as closely as possible to the Mode it was in, with the exact settings which were in place, when the save occurred. The Mode settings in each state file include the settings that are affected by Mode Preset, as well as the additional settings affected by Restore Mode Defaults; all of the Mode's settings. In addition, all of the settings of the **Input/Output** system are included, even though they are outside of the Mode's state, because they are needed to restore the complete setup. Persistent **System** settings (for example, Verbose SCPI) are not affected by either Mode Preset or Restore Mode Defaults, nor are they included in a saved State file.

After the save completes, the message "File <filename> saved" or "State Register <register number> saved" is displayed.

For rapid saving, the State menu lists 16 registers to save to. Pressing a Register key initiates the save. You can also select a file to save to.

The default path for all State Files is:

My Documents\<<mode name>\state

where <mode name> is the parameter used to select the mode with the INST:SEL command (for example, SA for the Spectrum Analyzer).

Key Path	Save
Mode	All
Remote Command	:MMEMory:STORe:STATe <filename>
Example	MMEM:STOR:STATe "MyStateFile.state" This stores the current instrument state data in the file MyStateFile.state in the default directory.
Notes	Both single and double quotes are supported for any filename parameter over remote. After saving to a register, that register's menu key is updated with the date the time, unless a custom label has been entered for that key. After saving to a register, you remain in the Save State menu, so that you can see the Register key

	update. After saving to a file, the analyzer automatically returns to the previous menu and any Save As dialog goes away.
Backwards Compatibility SCPI	:MMEMory:STORe:STATe 1,<filename>
Initial S/W Revision	Prior to A.02.00

To File . . .

When you press “To File”, the analyzer brings up a Windows dialog and a menu entitled “Save As.” This menu allows you to navigate to the various fields in the Windows dialog without using a keyboard or mouse. The **Tab** and **Arrow** keys can also be used for dialog navigation.

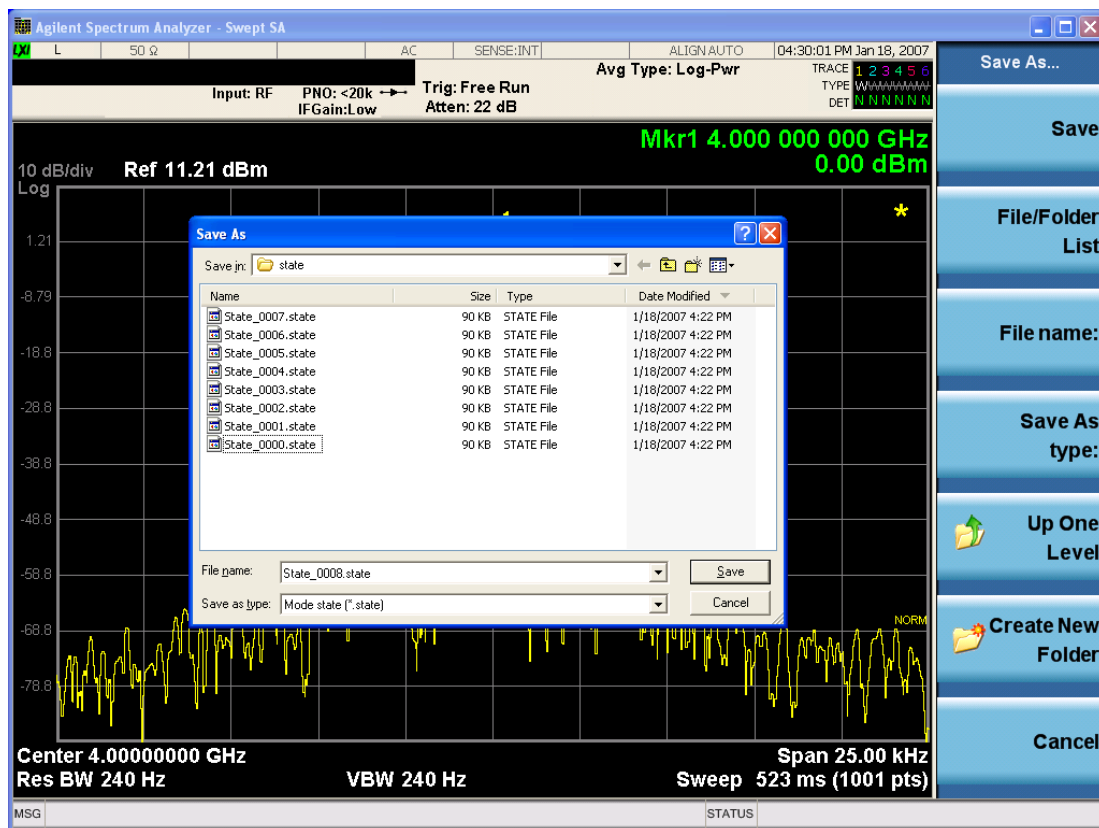

The Listed below

are the functions of the various fields in the dialog, and the corresponding softkeys:

Save

Performs the save to the specified file of the selected type. If the file already exists, a dialog will appear that allows you to replace the existing file by selecting **OK**, or you can Cancel the request. If you select OK, the file will be overwritten. Using the C: drive is strongly discouraged, since it runs the risk of being overwritten during an instrument software upgrade.

While the save is being performed, the floppy icon appears briefly in the Meas bar.

File/Folder List

Enables you to navigate to the center of the dialog that contains the list of files and folders. Once here you can get information about the file and use the tab keys to navigate to the other fields in the dialog, such as Save In.

Save In

The Save In field shows the path to which the file will be saved and allows you to change the path using the up and down arrow keys to navigate to other paths; the Enter key to open a directory; and the Backspace key to go back one directory. The **Save In field** defaults to the default path for this type of file and remembers the last path you used to save this type of file. There is no softkey for directly navigating to the Save In field but you can use left tab to get here from the File/Folder List.

User specified paths are remembered when you leave and return to a Mode and are reset back to the default using **Restore Mode Defaults**.

File Name

The **File Name** field is initially loaded with an automatically generated filename specific to the appropriate Save Type. The automatically generated filename is guaranteed not to conflict with any filename currently in the directory. You may replace or modify this filename using the File Name key. See the ["Quick Save " on page 582](#) documentation for more on the automatic file naming algorithm.

When you press the **File Name** key the analyzer displays the Alpha Editor. Use the knob to choose the letter to add and the front-panel Enter key to add the letter to the file name. The BK character moves you back and the FW character moves you forward in the filename. The Select key on the front panel generates a space character. When you are done entering the filename press the **Done** softkey. This returns back to the **File Open** dialog and menu, but does not cause the save to occur.

Save As Type

This field shows the file suffix for the type of file you have selected to save. For example, if you navigated here while saving State, "Mode state (*.state)" is in the field. If you navigated here from saving Trace, ""Mode state (*.trace)" is in the field. If you navigated here while exporting a trace data file, "Trace Data (*.csv)" is in the field. For some file types, there is more than one choice in the dropdown, which you can select by using the up and down arrow keys and Enter.

Up One Level

This key corresponds to the icon of a folder with the up arrow that is in the tool bar of the dialog. When pressed, it causes the file and folder list to navigate up one level in the directory structure. The Backspace key does the same thing.

Create New Folder

This key corresponds to the icon of a folder with the "*" that is in the tool bar of the dialog. When pressed, a new folder is created in the current directory with the name **New Folder** and you can enter a new folder name using the Alpha Editor.

Cancel

This key corresponds to the **Cancel** selection in the dialog. It causes the current **Save As** request to be cancelled. The ESC key does the same thing.

Key Path	Save, State
Mode	All
Notes	Brings up Save As dialog for saving a State Save Type
Initial S/W Revision	Prior to A.02.00

Edit Register Names

You may enter a custom name on any of the Register keys, to help you remember what you are using that state to save. To do this, press the **Edit Register Names** key, choose the register whose name you wish to edit, and then enter the desired label using the Alpha Editor or an external PC keyboard.

The maximum number of characters that can be added is 30. In most cases, 30 characters will fit on two lines of the key.

See ["More Information" on page 344](#)

Key Path	Save, State
Mode	All
Remote Command	:MMEMory:REGister:STATe:LABel <reg number>,"label" :MMEMory:REGister:STATe:LABel? <reg number>
Example	:MMEM:REG:STAT:LAB 1,"my label"
Notes	<reg number> is an integer from 1 to 16. If the SCPI specifies an invalid register number an error message is generated, -222,"Data out of range;Invalid register label number" "label" is a string from 0 to 30 characters in length. If a label exceeds 30 characters, an error message is generated, -150,"String data error;Label clipped to 30 characters" "label" of length 0 erases the custom label and restores the default (time and date) label. E.g.: :MMEM:REG:STAT:LAB 1,""
Dependencies	N9060A-7FP or N9060B-2FP license required to edit the register names. When the feature is not licensed, sending this command generates an error, -221,"Settings conflict;Option not available"
Preset	The names are unaffected by Preset or power cycle but are set to the default label (time and date) on a "Restore System Defaults->Misc"
Initial S/W Revision	A.11.00

More Information

When you edit one of the register names, the time and date field will be replaced by the custom name.

If you delete all the characters in the custom name, it restores the default (time and date).

The register names are stored within the state files, but they are not part of the instrument state; that is, once you have edited a register name, loading a new state will not change that register name. Another consequence of this is that the names will be persistent through a power cycle. Also, if a named state file is transferred to another analyzer, it will bring its custom name along with it.

If you try to edit the name of an empty register, the analyzer will first save the state to have a file to put the name in. If you load a named state file into an analyzer with older firmware it will ignore the metadata.

The *SAV and *RCL commands will not be affected by the custom register names, nor will the MMEM commands.

Register 1 thru Register 16

Selecting any one of these register menu keys causes the State of the currently active mode to be saved to the specified Register. The registers are provided for rapid saving and recalling, since you do not need to specify a filename or navigate to a file. Each of the register menu keys annotates whether it is empty or at what date and time it was last modified. In addition, you can use the **Edit Register Names** key to enter custom names for each register.

Although these 16 registers are the only registers available from the front panel, there are 128 state registers available in the instrument. Registers 17–128 are only available from the SCPI interface, using the *SAV command.

There is one set of 128 state registers in the instrument, not one set for each Mode. When a state is saved, the Mode it was saved from is saved with it; then when it is recalled, the instrument switches to that Mode.

After the save completes, the corresponding register menu key annotation is updated with the date and time and the message "Register <register number> saved" is displayed.

Key Path	Save, State
Mode	All
Example	*SAV 1
Range	1–16 from front panel, 1–128 from SCPI
Readback	Date and time with seconds resolution are displayed on the key OR A custom name of up to 30 characters entered using the Edit Register Names key OR “(empty)” if no prior save operation has been performed to this register.
Initial S/W Revision	Prior to A.02.00
Modified at S/W Revision	A.11.00

Register 1 thru Register 16

Selecting any one of these register menu keys causes the State of the currently active mode to be saved to the specified Register. The registers are provided for rapid saving and recalling, since you do not need to specify a filename or navigate to a file. Each of the register menu keys annotates whether it is empty or at what date and time it was last modified. In addition, you can use the **Edit Register Names** key to enter custom names for each register.

Although these 16 registers are the only registers available from the front panel, there are 128 state registers available in the instrument. Registers 17–128 are only available from the SCPI interface, using the *SAV command.

There is one set of 128 state registers in the instrument, not one set for each Mode. When a state is saved, the Mode it was saved from is saved with it; then when it is recalled, the instrument switches to that Mode.

After the save completes, the corresponding register menu key annotation is updated with the date and time and the message "Register <register number> saved" is displayed.

Key Path	Save, State
Mode	All
Example	*SAV 1
Range	1-16 from front panel, 1-128 from SCPI
Readback	Date and time with seconds resolution are displayed on the key OR A custom name of up to 30 characters entered using the Edit Register Names key OR “(empty)” if no prior save operation has been performed to this register.
Initial S/W Revision	Prior to A.02.00
Modified at S/W Revision	A.11.00

Mass Storage Catalog (Remote Command Only)

Key path	SCPI Only
Remote Command	:MMEMory:CATalog? [<directory_name>]
Notes	The string must be a valid logical path. Queries disk usage information (drive capacity, free space available) and obtains a list of files and directories in a specified directory in the following format: <numeric_value>,<numeric_value>,{<file_entry>} It returns two numeric parameters and as many strings as there are files and directories. The first parameter indicates the total amount of storage currently used in bytes. The second parameter indicates the total amount of storage available, also in bytes. The <file_entry> is a string. Each <file_entry> indicates the name, type, and size of one file in the directory list: <file_name>,<file_type>,<file_size> As the windows file system has an extension that indicates file type, <file_type> is always empty. <file_size> provides the size of the file in bytes. For directories, <file_entry> is surrounded by square brackets and both <file_type> and <file_size> are empty
Initial S/W Revision	Prior to A.02.00

Mass Storage Change Directory (Remote Command Only)

Key path	SCPI Only
Remote Command	:MMEMory:CDIRectory [<directory_name>] :MMEMory:CDIRectory?

Notes	<p>The string must be a valid logical path.</p> <p>Changes the default directory for a mass memory file system. The <directory_name> parameter is a string. If no parameter is specified, the directory is set to the *RST value.</p> <p>At *RST, this value is set to the default user data storage area, that is defined as System.Environment.SpecialFolder.Personal.</p> <p>Query returns full path of the default directory.</p>
Initial S/W Revision	Prior to A.02.00

Mass Storage Copy (Remote Command Only)

Key path	SCPI Only
Remote Command	:MMEMory:COpy <string>,<string>[,<string>,<string>]
Notes	<p>The string must be a valid logical path.</p> <p>Copies an existing file to a new file or an existing directory to a new directory.</p> <p>Two forms of parameters are allowed. The first form has two parameters. In this form, the first parameter specifies the source, and the second parameter specifies the destination.</p> <p>The second form has four parameters. In this form, the first and third parameters specify the source. The second and fourth parameters specify the directories. The first pair of parameters specifies the source. The second pair specifies the destination. An error is generated if the source doesn't exist or the destination file already exists.</p> <p>This command will generate an "access denied" error if the destination is a restricted folder (e.g., C:\Windows) and the current user does not have Power User or Administrator privileges.</p>

Mass Storage Device Copy (Remote Command Only)

This command transfers data to/from a file and a peripheral device.

Key path	SCPI Only
Remote Command	:MMEMory:COpy:DEvice <source_string>,<dest_string>
Notes	<p>The strings must be a valid logical path or a valid device keyword. If the dest_string is a device keyword, the data is copied from the source file to the device. If the source_string is a device keyword, the data is copied to the source file from the device.</p> <p>Valid device keywords are:</p> <p>SNS (smart noise source)</p> <p>An error is generated if the file or device is not found.</p>

Mass Storage Delete (Remote Command Only)

Key path	SCPI Only
Remote Command	:MMEMory:DElete <file_name>[,<directory_name>]

Notes	The string must be a valid logical path. Removes a file from the specified directory. The <file_name> parameter specifies the file name to be removed. This command will generate an “access denied” error if the file is in a restricted folder (e.g., C:\Windows) and the current user does not have Power User or Administrator privileges.
Initial S/W Revision	Prior to A.02.00

Mass Storage Data (Remote Command Only)

Creates a file containing the specified data OR queries the data from an existing file.

Key path	SCPI Only
Remote Command	:MMEMory:DATA <file_name>, <data> :MMEMory:DATA? <file_name>
Notes	The string must be a valid logical path. The command form is MMEMory:DATA <file_name>,<data>. It loads <data> into the file <file_name>. <data> is in 488.2 block format. <file_name> is string data. The query form is MMEMory:DATA? <file_name> with the response being the associated <data> in block format.
Initial S/W Revision	Prior to A.02.00

Mass Storage Make Directory (Remote Command Only)

Key path	SCPI Only
Remote Command	:MMEMory:MDIRectory <directory_name>
Notes	The string must be a valid logical path. Creates a new directory. The <directory_name> parameter specifies the name to be created. This command will generate an “access denied” error if the new directory would be in a restricted folder (e.g., C:\Windows) and the current user does not have Power User or Administrator privileges.
Initial S/W Revision	Prior to A.02.00

Mass Storage Move (Remote Command Only)

Key path	SCPI Only
Remote Command	:MMEMory:MOVE <string>,<string>[,<string>,<string>]
Notes	The string must be a valid logical path. Moves an existing file to a new file or an existing directory to a new directory. Two forms of parameters are allowed. The first form has two parameters. In this form, the first parameter specifies the source, and the second parameter specifies the destination. The second form has four parameters. In this form, the first and third parameters specify the source.

The second and fourth parameters specify the directories. The first pair of parameters specifies the source. The second pair specifies the destination. An error is generated if the source doesn't exist or the destination file already exists.

This command will generate an "access denied" error if the destination is a restricted folder (e.g., C:\Windows) and the current user does not have Power User or Administrator privileges.

Initial S/W Revision	Prior to A.02.00
----------------------	------------------

Mass Storage Remove Directory (Remote Command Only)

Key path	SCPI Only
----------	------------------

Remote Command	:MMEMory:RDIRectory <directory_name>
-----------------------	--------------------------------------

Notes	<p>The string must be a valid logical path.</p> <p>Removes a directory. The <directory_name> parameter specifies the directory name to be removed. All files and directories under the specified directory shall also be removed.</p> <p>This command will generate an "access denied" error if the folder is a restricted folder (e.g., C:\Windows) or is in a restricted folder and the current user does not have Power User or Administrator privileges.</p>
-------	--

Initial S/W Revision	Prior to A.02.00
----------------------	------------------

Sequences

These keys allow you to save a Tab separated or CSV file of the setup parameters required to build a Sequence.

In order to save you must select the Save As button and choose a destination folder.

Key Path	Save, Sequences
----------	------------------------

Mode	All
------	-----

Remote Command	:MMEM:STOR:SEquences: SLISt ALISt SAALISt SSTep "MySequence.txt"
-----------------------	---

Example	:MMEM:STOR:SEQ:SLISt "MySequence.txt"
----------------	---------------------------------------

Notes	<p>Available file types are:</p> <ul style="list-style-type: none"> –CSV (Comma delimited) (*.csv) –Text (Tab delimited) (*.txt)
-------	--

Initial S/W Revision	A.05.00
----------------------	---------

Source Sequence

The list of parameters, that configure steps, that makes up a sequence for the Source.

The Source sequence is a sequence of flexible configurable steps that can be set anywhere in the instruments frequency range.

Key Path	Save, Sequences
Example	:MMEM:STOR:SEQ:SLIS "MySequence.txt"
Dependencies	Only available in XOBT
Initial S/W Revision	A.05.00

Save As . . .

This menu lets you select the location where you can save the Sequence. This menu is a standard Windows® dialog with Save As menu keys. The "File Name" field in the Save As dialog is initially loaded with an automatically generated filename specific to the appropriate Save Type. The automatically generated filename is guaranteed not to conflict with any filename currently in the directory. You may replace or modify this filename using the File Name softkey. See the Quick Save key documentation for more on the automatic file naming algorithm.

The default path for all Sequence Files is:

My Documents\Sequences

Key Path	Save, Sequences
Mode	All
Notes	Brings up Save As dialog for saving a Sequence Save Type
Initial S/W Revision	A.05.00

Data (Export)

Exporting a data file stores data from the current measurement to mass storage files. The Export Menu only contains data types that are supported by the current measurement.

Since the commonly exported data files are in .csv format, the data can be edited by you prior to importing. This allows you to export a data file, manipulate the data in Excel (the most common PC Application for manipulating .csv files) and then import it.

Selecting an Export Data menu key will not actually cause the exporting to occur, since the analyzer still needs to know where you wish to save the data. Pressing the Save As key in this menu brings up the Save As dialog and Save As menu that allows you to specify the destination file and directory. Once a filename has been selected or entered in the Open menu, the export will occur as soon as the Save key is pressed.

Key Path	Save
Mode	All
Notes	The menu is built from whatever data types are available for the mode. So the key locations in the sub menu will vary. No SCPI command directly controls the Data Type that this key controls. The Data Type is included in

	the MMEM:STORe commands.
Dependencies	If a file type is not used by a certain measurement, that type is grayed out for that measurement. The key for a file type will not show at all if there are no measurements in the Mode that support it.
Preset	Is not affected by a Preset or shutdown, but is reset during Restore Mode Defaults
Readback	The data type that is currently selected
Initial S/W Revision	Prior to A.02.00

Amplitude Correction

Pressing this key selects **Amplitude Corrections** as the data type to be exported. Pressing this key again brings up the Select Menu, which allows the user to select which **Amplitude Correction** to save.

Amplitude Corrections are fully discussed in the documentation of the Input/Output key, under the Corrections softkey.

See "[Correction Data File](#)" on page 351

Key Path	Save
Remote Command	:MMEMory:STORe:CORRection 1 2 3 4 5 6, <filename>
Example	:MMEM:STOR:CORR 2 "myAmpcor.csv" saves Correction 2 to the file myAmpcor.csv on the current path. The default path is My Documents\amplitudeCorrections.
Notes	If the save is initiated via SCPI, and the file already exists, the file will be overwritten. Using the C: drive is strongly discouraged, since it runs the risk of being overwritten during an instrument software upgrade. Both single and double quotes are supported for any filename parameter over SCPI.
Dependencies	Corrections are not supported by all Measurements. If in a Mode in which some Measurements support it, this key will be grayed out in measurements that do not. The key will not show at all if no measurements in the Mode support it. This key will not appear unless you have the proper option installed in your instrument.
Readback	Selected Correction
Backwards Compatibility SCPI	:MMEMory:STORe:CORRection ANTenna CABLe OTHer USER, <filename> For backwards compatibility, ANTenna maps to 1, CABLe maps to 2, OTHer maps to 3 and USER maps to 4
Initial S/W Revision	A.02.00

Correction Data File

A Corrections Data File contains a copy of one of the analyzer correction tables. Corrections provide a way to adjust the trace display for predetermined gain curves (such as for cable loss).

Corrections files are text files in .csv (comma separated values) form, to make them importable into Excel or other spreadsheet programs. The format for Corrections files is as follows.

Line #	Type of field	Example	Notes
1	File type, must be "Amplitude Correction"	Amplitude Correction	May not be omitted
2	File Description (in quotes)	"Correction Factors for 11966E"	60 characters max; may be empty but may not be omitted. If exceeds 60 characters, error -233 Too much data reported
3	Comment (in quotes)	"Class B Radiated"	60 characters max; may be empty but may not be omitted. . If exceeds 60 characters, error -233 Too much data reported
4	Instrument Version, Model #	A.02.06,N9020A	May be empty but may not be omitted
5	Option List, File Format Version	K03 LFE EXM ,01	May be empty but may not be omitted
6	Freq Unit to be used for all frequency values in the file	Frequency Unit,MHz	assumed to be Hz if omitted
7	Antenna Unit	Antenna Unit,None	If omitted leaves the Antenna unit unchanged. The amplitude unit in the Antenna Unit field is a conversion factor that is used to adjust the Y Axis Units of the current mode, if the mode supports Antenna Units. For more details on antenna correction data, refer to the Input/Output,Corrections key description. Allowable values: dBuV/m, dBuA/m, dBG, dBpT, None
8	Freq Interpolation	Frequency Interpolation,Linear	if omitted leaves the Freq Interpolation unchanged. Allowable values: Linear, Logarithmic
9	Bias value in mA	Bias,0.00	If omitted leaves the Bias value unchanged (added as of A.08.50)
10	Bias State	Bias State,On	If omitted leaves the Bias State unchanged. Allowable values: On, Off (added as of A.08.50)
11	Overlap, two values, Freq1 and Freq2, separated by commas.	Overlap,33500,40000	Uses Freq Unit from line 6. Thus, in this example Freq1=33.5 GHz, Freq2= 40.0 GHz (see note below). If omitted leaves the overlap unchanged (added as of A.08.50)
12	DATA marker	DATA	Corrections data begins in the next line

Lines 2 through 5 can be empty but must appear in the file. Lines 6 through 11 are optional, the lines can be left out of the file altogether.

The Overlap row and the two Bias rows apply only to external mixing. Both are read-only, they are never written by the analyzer. The only way to insert or modify these rows is to edit the file with a text editor or a spreadsheet editor. These rows are intended for use by mixer manufacturers, as they allow the manufacturer to insert data about how the mixer corrections were generated and how they should be applied. The Bias rows allow you to specify whether to turn Bias on or off when the Correction is turned on and to specify a Bias value (turning off the Correction does not change the Bias, but turning it back on again sets it to the value specified in the file). The Overlap row allows you to specify an overlap region in which two different corrections may be applied. It is expected that in the corrections data itself, there will be TWO corrections values exactly at Max Freq, otherwise Overlap is ignored. The way the overlap is processed is as follows: if at any given time the current analyzer Start Freq is greater than Freq 1 and lower than Freq 2, and the current Stop Freq is greater than Freq 2, extend the first correction point at or above Freq 2 down to Freq 1, rather than using the correction data between Freq1 and Freq2.

The Antenna Unit row can only be used in Correction register 1, because there can only be one setting for Antenna Unit at any given time. If a Correction whose Antenna Unit is set to anything but None is loaded into any Correction register but 1, an error is generated (Mass storage error; Can only load an Antenna Unit into Correction 1). When a correction file is saved from any Correction register but 1, Antenna Unit is always written as None.

Similarly, the Bias rows can only be used in Correction register 1, because there can only be one setting for Bias at any given time. If a Correction file with a Bias or Bias State row is loaded into any Correction register but 1, an error is generated: Mass storage error; Can only load Bias Settings into Correction 1

The data follows the DATA row, as comma separated X, Y pairs; one pair per line.

For example, suppose you have an Antenna to correct for on an N9020A version A.02.06 and the correction data is:

- 0 dB at 200 MHz
- 17 dB at 210 MHz
- 14.8 dB at 225 MHz

Then the file will look like:

- Amplitude Correction
- "Correction Factors for 11966E"
- "Class B Radiated"
- A.02.06,N9020A
- P13 EA3 UK6,01
- Frequency Unit,MHz
- Antenna Unit,dBuV/m
- Frequency Interpolation,Linear
- DATA
- 200.000000,0.00
- 210.000000,17.00

- 225.000000,14.80

The choices for the 1 of N fields in the metadata are as follows:

- Frequency Unit: Hz, kHz, MHz, GHz
- Antenna Unit: dBuv/m, dBuA/m, dBG, dBpT, None
- Frequency Interpolation: Logarithmic, Linear

Amplitude Correction

These keys let you choose which Correction to save. Once selected, the key returns back to the Export Data menu and the selected Correction number is annotated on the key.

The next step in the Save process is to select the Save As key in the Export Data menu.

Key Path	Save, Data, Amplitude Correction
Preset	Not part of a Preset, but is reset to Correction 1 by Restore Input/Output Defaults. Survives a shutdown.
Readback	1
Initial S/W Revision	A.02.00

Measurement Results

Pressing this key selects Meas Results as the data type to be exported. Pressing the key a second time brings up the Meas Results menu, which allows you to select which **Meas Result** to save. In the Swept SA measurement, there are three types of Measurement Results files: Peak Table, Marker Table and Spectrogram.

See "[Meas Results File Contents](#)" on page 355.

See "[Marker Table](#)" on page 355.

See "[Peak Table](#)" on page 358.

See "[Spectrogram](#)" on page 360

Remote Command	:MMEMory:STORe:RESults:MTABle PTABle SPEctrogram <filename>
Example	:MMEM:STOR:RES:MTAB "myResults.csv" Saves the results from the current marker table to the file myResults.csv in the current path. :MMEM:STOR:RES:PTAB "myResults.csv" Saves the results from the current peak table to the file myResults.csv in the current path. :MMEM:STOR:RES:SPEC "myResults.csv" Saves the results from the current Spectrogram display to the file myResults.csv in the current path. The default path is My Documents\SA\data\SAN\results
Notes	If the save is initiated via SCPI, and the file already exists, the file will be overwritten. Using the C: drive is strongly discouraged, since it runs the risk of being overwritten during an instrument software upgrade. Both single and double quotes are supported for any filename parameter over SCPI.

Dependencies	<p>If a save of Marker Table results is requested and the Marker Table is not on, no file is saved and a message is generated</p> <p>If a save of Peak Table results is requested and the Peak Table is not on, no file is saved and a message is generated</p> <p>If a save of Spectrogram results is requested and the Spectrogram is not on, no file is saved and a message is generated.</p> <p>The Spectrogram choice only appears if option EDP is licensed.</p>
Preset	Not part of Preset, but is reset to Peak Table by Restore Mode Defaults. Survives a shutdown.
Initial S/W Revision	Prior to A.02.00

Meas Results File Contents

All files are .csv files. The following section details the data in each file type.

Marker Table

This section discusses the Marker Table Meas Results file format.

Imagine that, at the point where a Marker Table Meas Result is requested, the following screen is showing:

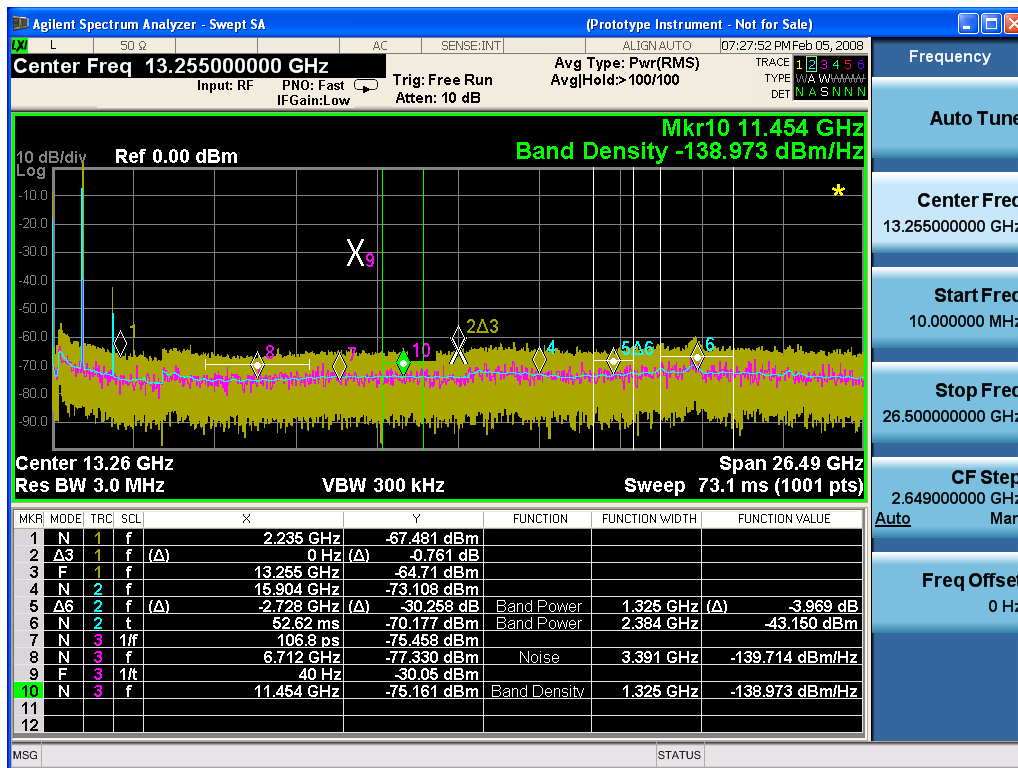

Then the Meas Results file, when opened, would show the following data:

MeasurementR
result

Swept SA	
A.01.40_R0017	N9020A
526 B25 PFR P26 EA3	1
Result Type	Marker Table
Ref Level	0
Number of Points	1001
Sweep Time	0.0662666 67
Start Frequency	10000000
Stop Frequency	26500000 000
Average Count	0
Average Type	LogPower (Video)
RBW	3000000
RBW Filter	Gaussian
RBW Filter BW	3dB
VBW	3000000
Sweep Type	Swept
X Axis Scale	Lin
PreAmp State	Off
PreAmp Band	Low
Trigger Source	Free
Trigger Level	1.2
Trigger Slope	Positive
Trigger Delay	1.00E-06
Phase Noise Optimization	Fast
Swept If Gain	Low
FFT If Gain	Autorange
RF Coupling	AC
FFT Width	411900
Ext Ref	10000000
Input	RF
RF Calibrator	Off

Attenuation	10								
Ref Level Offset	0								
External Gain	0								
X Axis Units	Hz								
Y Axis Units	dBm								
DATA									
MKR	MODE	TR C	SCL	X	Y	FUNCTI ON	FUNCTIO N WIDTH	FUNCTI ON VALUE	FUNCTI ON UNIT
1	Normal	1	Freque ncy	2.2350E+09	- 67.481	Off	0.0000E+00	0	None
2	Delta3	1	Freque ncy	0.0000E+00	- 0.761	Off	0.0000E+00	0	None
3	Fixed	1	Freque ncy	1.3255E+10	- 64.71	Off	0.0000E+00	0	None
4	Normal	2	Freque ncy	1.5904E+10	- 73.108	Off	0.0000E+00	0	None
5	Delta7	2	Freque ncy	- 2.7280E+09	- 30.258	Band Power	1.3250E+06	-3.969	dB
6	Normal	2	Time	5.2620E-02	- 70.177	Band Power	2.3840E+06	-43.15	dBm
7	Normal	3	Period	1.0680E-10	- 75.458	Off	0.0000E+00	0	None
8	Normal	3	Freque ncy	6.7120E+09	- 77.33	Noise	3.3910E+06	- 139.714	dBm/Hz
9	Fixed	3	Inverse Time	4.0000E+01	- 30.05	Off	0.0000E+00	0	None
10	Normal	3	Freque ncy	1.1454E+10	- 75.161	Band Density	1.3250E+06	- 138.973	dBm/Hz
11	Off	1	Freque ncy	0.0000E+00	0	Off	0.0000E+00	0	None
12	Off	1	Freque ncy	0.0000E+00	0	Off	0.0000E+00	0	None

The numbers appear in the file exactly as they appear onscreen. If it says 11.454 GHz onscreen, then in the file it is 11.454E+09.

The metadata header is very similar to the metadata used in the trace data .csv files. See Trace File Contents. The only new information concerns the 1-of-N fields in the marker table itself.

Peak Table

This section discusses the Peak Table Meas Results file format.

Imagine that, at the point where a Marker Table Meas Result is requested, the following screen is showing:

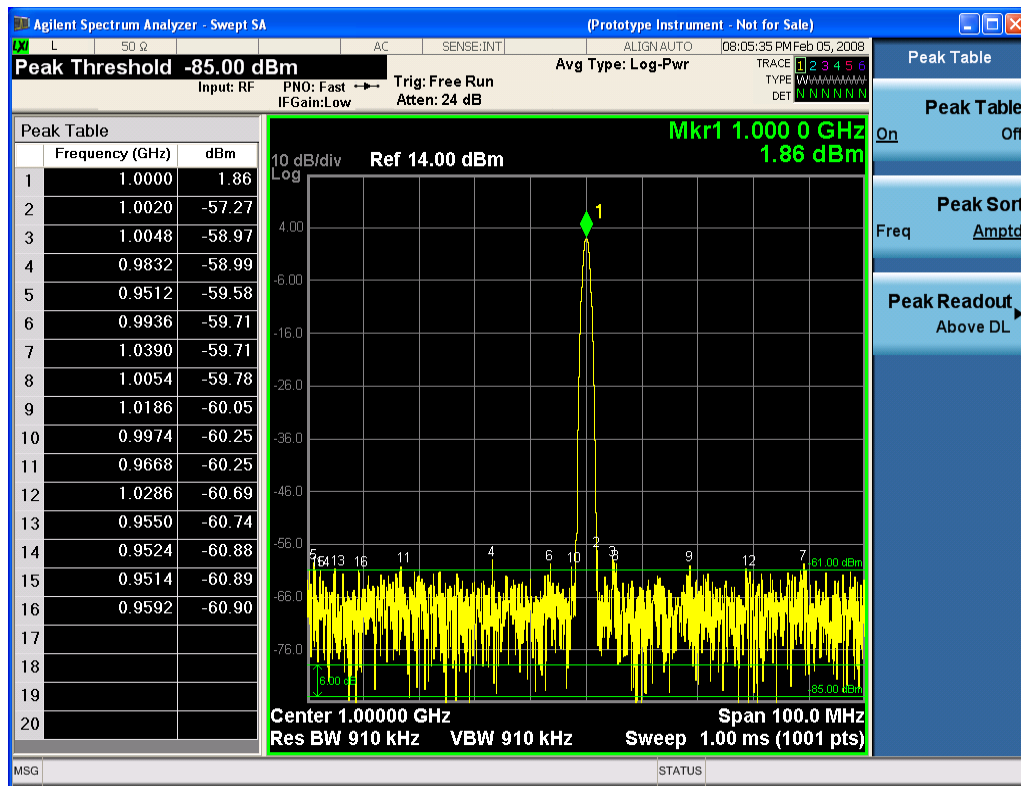

Then the Meas Results file, when opened, would show the header data (the same as for the Marker Table except that the Result Type is Peak Table) ending with a few fields of specific interest to Peak Table users:

- Peak Threshold
- Peak Threshold State (On|Off)
- Peak Excursion
- Peak Excursion State (On|Off)
- Display Line
- Peak Readout (All|AboveDL|BelowDL)
- Peak Sort (Freq|Amptd)

These fields are then followed by the data for the Peak Table itself.

Note that the label for the Frequency column changes to Time in 0 span.

Here is what the table for the above display looks like:

MeasurementResult	
Swept SA	
A.01.40_R0017	N9020A
526 B25 PFR P26 EA3	1
Result Type	Peak Table
Ref Level	0
Number of Points	1001
Sweep Time	0.066266667
Start Frequency	10000000
Stop Frequency	26500000000
Average Count	0
Average Type	LogPower(Video)
RBW	3000000
RBW Filter	Gaussian
RBW Filter BW	3dB
VBW	3000000
Sweep Type	Swept
X Axis Scale	Lin
PreAmp State	Off
PreAmp Band	Low
Trigger Source	Free
Trigger Level	1.2
Trigger Slope	Positive
Trigger Delay	1.00E-06
Phase Noise Optimization	Fast
Swept If Gain	Low
FFT If Gain	Autorange
RF Coupling	AC
FFT Width	411900
Ext Ref	10000000
Input	RF
RF Calibrator	Off
Attenuation	10
Ref Level Offset	0
External Gain	0

X Axis Units	Hz	
Y Axis Units	dBm	
Peak Threshold	-85	
Peak Threshold State	On	
Peak Excursion	6	
Peak Excursion State	On	
Display Line	-61	
Peak Readout	AboveDL	
Peak Sort	Amptd	
DATA		
Peak	Frequency	Amplitude
1	1.0000E+06	1.86
2	1.0020E+06	-57.27
3	1.0048E+06	-58.97
4	9.8320E+05	-58.99
5	9.5120E+05	-59.58
6	9.9360E+05	-59.71
7	1.0390E+06	-59.71
8	1.0054E+06	-59.78
9	1.1086E+06	-60.05
10	9.9740E+05	-60.25
11	9.6680E+05	-60.25
12	1.0286E+06	-60.69
13	9.5500E+05	-60.74
14	9.5240E+05	-60.88
15	9.5140E+05	-60.89
16	9.5920E+05	-60.90
17		
18		
19		
20		

Spectrogram

This section discusses the Spectrogram Results file format. The Spectrogram choice only appears if option EDP is licensed.

The Spectrogram results are the same as a Trace data export, except that instead of having just one trace's data, all 300 traces appear one after the other.

Each trace has its own data mark; the data for Spectrogram Trace 0 follows the row marked DATA, the data for Spectrogram Trace 1 follows the row marked DATA1, for Spectrogram Trace 2 follows the row marked DATA2, and so on.

Each DATA row has a timestamp in the second column (as of firmware revision A.11.01). So, for example, if Trace 0 had a relative start time of 1729.523 sec, then the first DATA row would look like this:

```
DATA,1729.523
```

And if Trace 13 had a relative start time of 100.45 sec, then the fourteenth data row would look like:

```
DATA13,100.453
```

To find the absolute time for the relative timestamps of each trace, the last row before the first DATA row gives the absolute start time of the Spectrogram, in the form YYYYMMDDHHMMSS

So, for example, if the absolute start time is 13:23:45:678 on January 30, 2012, this row would look like:

```
Start Time,20120130132345678
```

NOTE:

NOTE

The resolution of the absolute time stored is 1 ms, which matches up with the fact that the fastest sweep time is also 1 ms. However, there is no specification for the absolute accuracy of the clock in the analyzer, nor is there any facility provided to allow the user to set this time to any particular degree of accuracy.

Traces that have not yet been filled in the Spectrogram display are empty; there is no DATA header for them. The file ends after the last non-empty trace.

Imagine that, at the point where a Spectrogram Meas Result is requested, the following screen is showing:

8 Complex Spectrum Measurement
Save

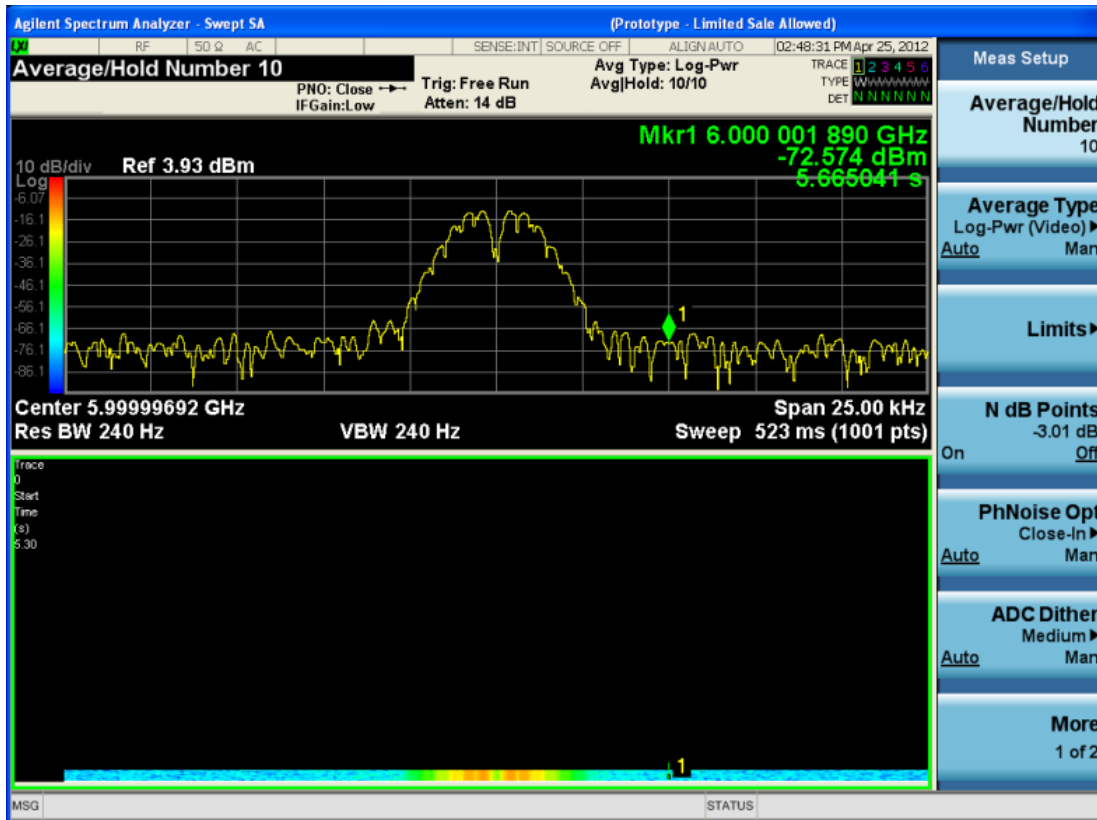

For the purpose of this example, we have set the Average/Hold Number to 10, thus we have only traces 0 thru 10. The Spectrogram was started at 02:28:08:700 pm on April 25, 2012 (that is, 700 ms after 2:28:08 pm), although the screen dump itself shows a different time, as it was taken ten minutes after the Spectrogram data. Trace 0 is showing a start time of 5.30 seconds, meaning 5.3 seconds after the Spectrogram started (trace 10 has a start time of 0, as it was the first trace taken but has now rolled up into the tenth trace slot).

The Meas Results file, when opened, shows the header data and ten traces of trace data. Below is an extract from the result file for the above display. Note the start time of 20120425142808700 showing in the last row before the first DATA row, and the relative time of 5.299231048 showing in the first DATA row:

Result Type	Spectrogram
MeasResult	
Swept SA	
A.11.00.01	N9020A
503 508 513 526 ALL ALV B1C B1X B25 B2X B40 BAB BBA CR3 CRP DP2 DRD EA3 EDP EMC EP1 ERC ESC ESP EXM FSA HBA K03 LFE MPB P03 P08 P13 P26 PFR RTL RTS S40 SB1 SEC SM1 UK6 YAS YAV	1
Segment	0

Result Type	Spectrogram
Number of Points	1001
Sweep Time	0.523333333
Start Frequency	5999984415
Stop Frequency	6000009415
Average Count	0
Average Type	LogPower(Video)
RBW	240
RBW Filter	Gaussian
RBW Filter BW	3dB
VBW	240
Sweep Type	Swept
X Axis Scale	Lin
PreAmp State	Off
PreAmp Band	Low
Trigger Source	Free
Trigger Level	1.2
Trigger Slope	Positive
Trigger Delay	0
Phase Noise Optimization	Wide
Swept If Gain	Low
FFT If Gain	Autorange
RF Coupling	AC
FFT Width	411900
Ext Ref	10000000
Input	RF
RF Calibrator	Off
Attenuation	14
Ref Level Offset	0
External Gain	0
Trace Type	Clearwrite
Detector	Normal
Trace Math	Off
Trace Math Oper1	Trace5
Trace Math Oper2	Trace6
Trace Math Offset	0
Trace Name	Trace1

8 Complex Spectrum Measurement

Save

Result Type	Spectrogram
X Axis Units	Hz
Y Axis Units	dBm
Start Time	20120425142808700
DATA	5.299231048
5999984415	-76.34749519
5999984440	-77.28097006
5999984465	-75.32317869
5999984490	-73.64417681
5999984515	-72.67154604

-
-
-

6000009315	-77.94423277
6000009340	-79.51829697
6000009365	-78.46108961
6000009390	-78.46108957
6000009415	-76.59570596
DATA2	4.708697055
5999984415	-80.98197882
5999984440	-80.98197879
5999984465	-75.83142132
5999984490	-74.02712079
5999984515	-73.57213005

-
-
-

6000009315	-75.9183103
6000009340	-79.53787488
6000009365	-78.82602191
6000009390	-78.82602188
6000009415	-76.37486709

DATA10	0
5999984415	-75.56751112
5999984440	-75.76485645
5999984465	-76.67718717
5999984490	-78.79238489
5999984515	-83.72680212

o
o
o

6000009315	-71.3942461
6000009340	-72.28308332
6000009365	-73.92684489
6000009390	-75.45548832
6000009415	-75.17904815

Save As . . .

When you press “Save As”, the analyzer brings up a Windows dialog and a menu entitled “**Save As.**” This menu allows you to navigate to the various fields in the Windows dialog without using a keyboard or mouse. The **Tab** and **Arrow** keys can also be used for dialog navigation.

See "[To File . . .](#)" on page 597 in **Save, State** for a full description of this dialog and menu.

The default path for saving files is:

For all of the Trace Data Files:

My Documents\`<mode name>`\data\traces

For all of the Limit Data Files:

My Documents\`<mode name>`\data\limits

For all of the Measurement Results Data Files:

My Documents\`<mode name>`\data\`<measurement name>`\results

For all of the Capture Buffer Data Files:

My Documents\`<mode name>`\data\captureBuffer

Key Path	Save, Data
Mode	All

Notes	The key location is mode-dependent and will vary. Brings up the Save As dialog for saving a <mode specific> Save Type. The save is performed immediately and does not wait until the measurement is complete.
Initial S/W Revision	Prior to A.02.00

Screen Image

Pressing Screen Image accesses a menu of functions that enable you to specify a format and location for the saved screen image. It brings up a menu that allows you to specify the color scheme of the Screen Image (Themes) or navigate to the Save As dialog to perform the actual save.

Screen Image files contain an exact representation of the analyzer display. They cannot be loaded back onto the analyzer, but they can be loaded into your PC for use in many popular applications.

The image to be saved is actually captured when the **Save** front panel key is pressed, and kept in temporary storage to be used if you ask for a Screen Image save. When the Screen Image key is pressed, a "thumbnail" of the captured image is displayed, as shown below:

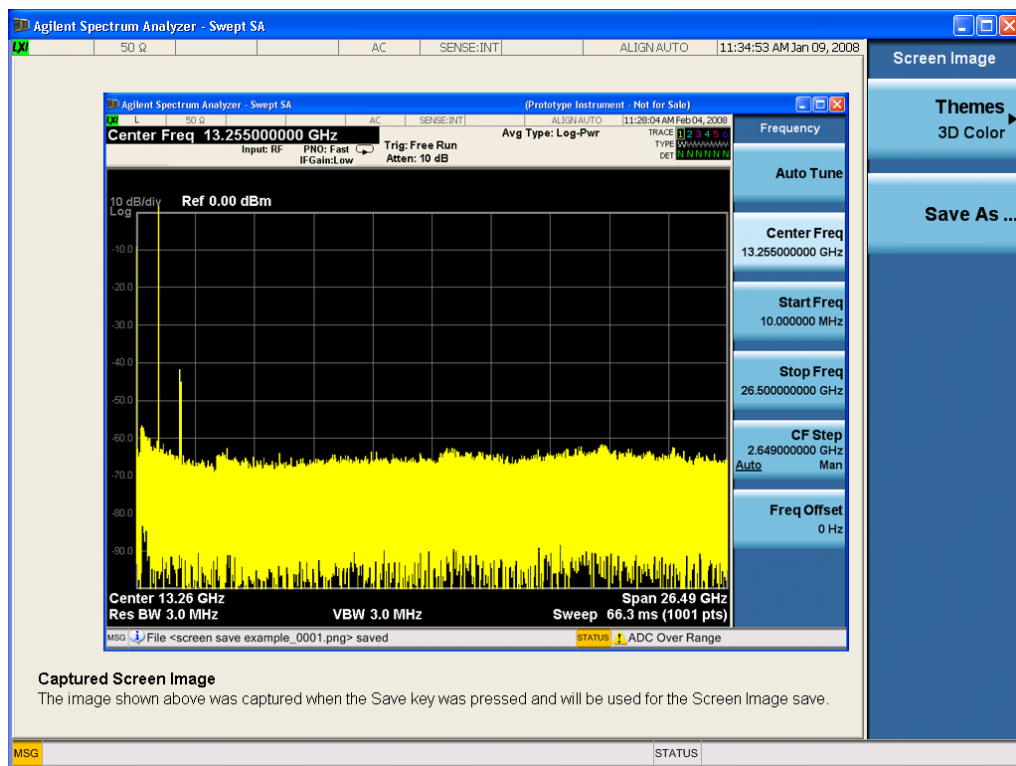

When you continue on into the **Save As** menu and complete the Screen Image save, the image depicted in the thumbnail is the one that gets saved, showing the menus that were on the screen before going into the **Save** menus. The save is performed immediately and does not wait until the measurement is complete.

After you have completed the save, the **Quick Save** front-panel key lets you quickly repeat the last save performed, using an auto-named file, with the current screen data.

NOTE

For versions previous to A.01.55, if you initiate a screen image save by navigating through the Save menus, the image that is saved will contain the Save menu softkeys, not the menus and the active function that were on the screen when you first pressed the Save front panel key.

Key Path	Save
Mode	All
Remote Command	:MMEMory:STORe:SCReen <filename>
Example	:MMEM:STOR:SCR "myScreen.png" This stores the current screen image in the file MyScreenFile.png in the default directory.
Initial S/W Revision	Prior to A.02.00

Themes

Accesses a menu of functions that enable you to choose the theme to be used when saving the screen image.

The **Themes** option is the same as the **Themes** option under the **Display** and **Page Setup** dialogs. It allows you to choose between themes to be used when saving the screen image.

Key Path	Save, Screen Image
Remote Command	:MMEMory:STORe:SCReen:THEME TDColor TDMonochrome FColor FMONochrome :MMEMory:STORe:SCReen:THEMe?
Example	:MMEM:STOR:SCR:THEM TDM
Preset	3D Color; Is not part of Preset, but is reset by Restore Misc Defaults or Restore System Defaults All and survives subsequent running of the modes.
Readback	3D Color 3D Mono Flat Color Flat Mono
Backwards Compatibility Notes	In ESA and PSA we offer the choice of "Reverse Bitmap" or "Reverse Metafile" when saving screen images. This is much like the "Flat Color" theme available in X-Series. Also, if you selected Reverse Bitmap AND a black & white screen image, that would be much like "Flat Monochrome". In other words, each of the X-Series themes has a similar screen image type in ESA/PSA. But they are not identical.
Initial S/W Revision	Prior to A.02.00

3D Color

Selects a standard color theme with each object filled, shaded and colored as designed.

Key Path	Save, Screen Image, Themes
Example	MMEM:STOR:SCR:THEM TDC
Readback	3D Color
Initial S/W Revision	Prior to A.02.00

3D Monochrome

Selects a format that is like 3D color but shades of gray are used instead of colors.

Key Path	Save, Screen Image, Themes
Example	MMEM:STOR:SCR:THEM TDM
Readback	3D Mono
Initial S/W Revision	Prior to A.02.00

Flat Color

Selects a format that is best when the screen is to be printed on an ink printer.

Key Path	Save, Screen Image, Themes
Example	MMEM:STOR:SCR:THEM FCOL
Readback	Flat Color
Initial S/W Revision	Prior to A.02.00

Flat Monochrome

Selects a format that is like Flat Color. But only black is used (no colors, not even gray), and no fill.

Key Path	Save, Screen Image, Themes
Example	MMEM:STOR:SCR:THEM FMON
Readback	Flat Mono
Initial S/W Revision	Prior to A.02.00

Save As...

When you press "Save As", the analyzer brings up a Windows dialog and a menu entitled "**Save As.**" This menu allows you to navigate to the various fields in the Windows dialog without using a keyboard or mouse. The **Tab** and **Arrow** keys can also be used for dialog navigation.

See "[To File . . .](#)" on page 597 in **Save, State** for a full description of this dialog and menu.

The default path for Screen Images is

My Documents\`<mode name>`\screen.

where `<mode name>` is the parameter used to select the mode with the INST:SEL command (for example, SA for the Spectrum Analyzer).

Key Path	Save, Screen Image
Notes	Brings up Save As dialog for saving a Screen Image Save Type
Initial S/W Revision	Prior to A.02.00

Single (Single Measurement/Sweep)

Sets the analyzer for Single measurement operation. The single/continuous state is Meas Global, so the setting will affect all the measurements. If you are Paused, pressing **Single** does a Resume.

See "[More Information](#)" on page 370

Key Path	Front-panel key
Example	:INIT:CONT OFF
Notes	See Cont key description.
Backwards Compatibility Notes	<p>For Spectrum Analysis mode in ESA and PSA, the Single hardkey and the INITiate:IMM switched from continuous measurement to single measurement and restarted sweeps and averages (displayed average count reset to 1), but did not restart Max Hold and Min Hold. In the X-Series, the Single hardkey and the INITiate:IMM command initiate a sweep/ measurement/ average sequence/hold sequence including MaxHold and MinHold.</p> <p>For Spectrum Analysis mode in ESA and PSA, the Single hardkey restarted the sweep regardless of whether or not you were in an active sweep or sweep sequence. In the X-Series, Restart does this but Single only restarts the sweep or sweep sequence if you are in the idle state.</p> <p>INIT[:IMM] in ESA & PSA Spectrum Analysis Mode does an implied ABORT. In some other PSA Modes, INIT[:IMM] is ignored if not in the idle state. . The X-Series follows the ESA/PSA SA Mode model, which may cause some Modes to have compatibility problems.</p>
Initial S/W Revision	Prior to A.02.00

More Information

See "[Restart](#)" on page 594 for details on the INIT:IMMEDIATE (Restart) function.

If you are already in single sweep, the INIT:CONT OFF command has no effect.

If you are already in Single Sweep, then pressing the **Single** key in the middle of a sweep does not restart the sweep or sequence. Similarly, pressing the **Single** key does not restart the sweep or sequence if the sweep is not in the idle state (for example, if you are taking a very slow sweep, or the analyzer is waiting for a trigger). Instead, it results in a message. "Already in Single, press Restart to initiate a new sweep or sequence". Even though pressing the **Single** key in the middle of a sweep does not restart the sweep, sending INIT:IMMEDIATE does reset it.

To take one more sweep without resetting the average count, increment the average count by 1, by pressing the step up key while **Average/Hold Number** is the active function, or sending the remote command CALC:AVER:TCON UP.

Source

Opens a menu of keys that access various source configuration menus and settings. In the test set, pressing this key also causes the central view area to change and display the Source Control Main view.

Key Path	Front-panel key
----------	-----------------

RF Output

This parameter sets the source RF power output state.

Key Path	Source
Remote Command	:OUTPut[:EXTernal][:STATe] ON OFF 1 0 :OUTPut[:EXTernal][:STATe]?
Example	OUTP OFF OUTP?
Notes	<p>The EXTERNAL node is shown in RD text so the SCPI remains the same between internal and external source control. However, for EXT we do not wish to document this node to the customer since we are controlling the internal source rather than the external source.</p> <p>This setting is for the independent mode and has no effect on the "List Sequencer" on page 712. If the "Sequencer" on page 713 is set to ON, the list sequencer controls the source output and this key will be grayed-out. And this setting will be non-forceful grey out on front panel to indicate out-of-scope. Non-forceful means user still can change this setting by SCPI but cannot change on front panel. When set to OFF will make source leave list sequencer and this setting will be black out and take effect immediately.</p> <p>When the RF Output is ON, an "RF" annunciator is displayed in the system settings panel. When the RF Output is turned Off, the RF annunciator is cleared. If the "Sequencer" on page 713 is set to ON, the "RF" annunciator will be replaced by "SEQ" in the system settings panel, indicating that the output is controlled by the list sequencer.</p>
Preset	Off
Range	On Off
Initial S/W Revision	A.05.00

Amplitude

Allows you to access the Amplitude sub-menu.

Key Path	Source
Notes	<p>The sub-menu under this button is for independent mode and has no effect on "List Sequencer" on page 712. If the "Sequencer" on page 713 is set to ON, the list sequencer controls the source output and this key will be grayed-out on front panel to indicate out-of-scope. When you set "Sequencer" on page 713 to Off will make source leave list sequencer and this button will be black out.</p>
Initial S/W Revision	A.05.00

RF Power

Allows you to adjust the power level of the source using the numeric keypad, step keys, or RPG. Pressing any digit, 0 through 9, on the numeric keypad brings up the unit terminator.

Please refer to the "[RF Power Range](#)" on page 373 table below for the valid ranges.

Key Path	Source, Amplitude
Remote Command	:SOURce:POWer[:LEVel][:IMMediate][:AMPLitude] <ampl> :SOURce:POWer[:LEVel][:IMMediate][:AMPLitude]?
Example	:SOUR:POW -100 dBm
Notes	<p>Amplitude corrections can be specified for use with the source. In the event of amplitude corrections being applied, the valid ranges for the RF power do not change dependant on the current amplitude correction setting. If the combination of RF power + amplitude correction is higher or lower than the source output range, the Source Unleveled bit is set and the "Source Unleveled" indicator will appear on status panel to indicate that the source cannot maintain the output power that has been requested.</p> <p>When signal generator is unable to maintain the requested output level, the "Source Unleveled" indicator will appear on status panel. When the source output setting is restored to the normal range, the "Source Unleveled" is removed from status panel.</p> <p>Internal source has list sequence mode, which comprises of several steps which contain separate output power, frequency and waveform etc. When the source list sequence playing is complete, the last step keeps playing, and user can use this command to change the list sequence last step's output power.</p> <p>The multiport adapter RFIO TX ports and GPS ports cannot ensure power accuracy when power setting is lower than -130dBm, this power setting value is defined by the sum of RF Power setting and related amplitude correction value. But user settable value could be lower than this limit. When application detected there exists power setting lower than -130dBm on MPA RFIO TX ports, then popup warning message . When application detected there exists power setting lower than -130dBm on MPA GPS ports, then popup warning message . This is only warning message, and check is performed when RF is ON.</p>
Notes	The Min and Max value here defined UI settable amplitude range. This range is larger than actual amplitude range with level accuracy defined in spec.
Dependencies	The RF power is dependent on the RF output port and frequency, such that the current frequency and selected output port determine the valid range of power values.
Couplings	If " Real-Time AWGN " on page 673 AWGN State is On and " ARB " on page 662 ARB State is On, this setting will be adjusted to the value to maintain the AWGN power relationship defined by " Power Control Mode " on page 674 Power Control Mode and other noise settings
Preset	-100 dBm
Min	The range of values depends on the current frequency and selected RF output port. Please refer to the " RF Power Range " on page 373 table below for the valid ranges.
Max	The range of values depends on the current frequency and selected RF output port. Please refer to the " RF Power Range " on page 373 table below for the valid ranges.
Initial S/W Revision	A.05.00
Modified at S/W Revision	A.16.00 (Add couplings with AWGN state)

RF Power Range

RF Output Port	Frequency Range	Min Output Power	Max Output Power
High Power RF Out	10 MHz ≤ f ≤ 6 GHz	-150 dBm	20 dBm
RFIO 1 & RFIO 2	10 MHz ≤ f ≤ 6 GHz	-150 dBm	0 dBm
GPS (Note2)	10 MHz ≤ f ≤ 6 GHz	-150 dBm	0 dBm

Note: This is the UI power range, it's larger than actual spec.

Note2: GPS port is on the multiport adapter, or E6607C which has embedded MPA.

Set Reference Power

This key allows you to set the power reference. Pressing this key turns the power reference state to ON, sets the reference power value to the current RF output power, maintains this power at the RF output, and sets the displayed power to 0.00 dB. All subsequent RF power values entered under Source>Amplitude>RF Power are interpreted as being relative to this reference power.

When you use a power reference, the signal generator outputs an RF power that is set relative to the reference power by the value entered under Source>Amplitude>RF Power as follows:

Output power = reference power – entered power

Where:

reference power equals the original RF Power entered under Source>Amplitude>RF Power and set as the reference power

entered power equals a new value entered under Source>Amplitude>Amptd Offset

In addition, the displayed power value is the same as a new value entered under Source>Amplitude>RF Power.

NOTE

If Power Ref is set to ON with a reference value set, entering a value under Source>Amplitude>RF Power and pressing Set Reference Power will add that value to the existing Power Ref value.

If you wish to change the reference power value to a new value entered under Source>Amplitude>RF Power, first you must set Power Ref to OFF and then press Set Reference Power.

Key Path	Source, Amplitude
Dependencies	This key is unavailable, and is grayed out when the "List Sequencer" on page 712 is turned ON.
Initial S/W Revision	A.05.00

Power Ref

This key allows you to toggle the state of the power reference.

When you use a power reference, the signal generator outputs an RF power that is set relative to the reference power by the value entered under Source>Amplitude>RF Power as follows:

$$\text{Output power} = \text{reference power} + \text{entered power}$$

Where:

reference power equals the original RF Power entered under Source>Amplitude>RF Power and set as the reference power

entered power equals a new value entered under Source>Amplitude>Amptd Offset

For more information on Reference Frequency refer to ["Set Reference Power " on page 628](#)

Key Path	Source, Amplitude
Remote Command	:SOURce:POWer:REFeRence <ampl> :SOURce:POWer:REFeRence? :SOURce:POWer:REFeRence:STATe OFF ON 0 1 :SOURce:POWer:REFeRence:STATe?
Example	:SOUR:POW:REF 0.00 dBm :SOUR:POW:REF:STATe ON
Dependencies	This setting is unavailable and is grayed out when the "List Sequencer" on page 712 is turned ON.
Couplings	This value is coupled to the "Set Reference Power " on page 628 key such that pressing the Set Reference Power key updates the reference power with the current output power.
Preset	0.00 dBm OFF
Min	-125.00 dBm
Max	10.00 dBm
Initial S/W Revision	A.05.00

Amptd Offset

Allows you to specify the RF output power offset value.

When the amplitude offset is set to zero (0) and you set a new offset value (positive or negative), the displayed amplitude value will change as follows and the RF output power will not change:

$$\text{Displayed value} = \text{output power} + \text{offset value}$$

Where:

output power equals the original RF Power entered under Source>Amplitude>RF Power

offset value equals the value entered under Source>Amplitude>Amptd Offset

When the amplitude offset is set to a value other than zero (0) and you enter a new RF power value under Source>Amplitude>RF Power, the displayed power will be the same as the value entered and the RF output power will be equal to the value entered minus the offset value as follows:

$$\text{Output power} = \text{entered power} - \text{offset power}$$

Displayed Power = output power + offset power

Displayed power = entered power

Where:

entered power equals the amplitude entered under Source>Amplitude>RF Power

offset power equals the value previously entered and set under Source>Amplitude>Amptd Offset

Key Path	Source, Amplitude
Remote Command	:SOURce:POWer[:LEVel][:IMMediate]:OFFSet <rel_ampl> :SOURce:POWer[:LEVel][:IMMediate]:OFFSet?
Example	:SOUR:POW:OFFS 0.00 dB
Dependencies	This setting is unavailable, and is grayed out when the List Sequencer is turned ON.
Preset	0.00 dB
Min	-200.00 dB
Max	200.00 dB
Initial S/W Revision	A.05.00

Modulation

Allows you to toggle the state of the modulation.

Key Path	Source
Remote Command	:OUTPut:MODulation[:STATe] ON OFF 1 0 :OUTPut:MODulation[:STATe]?
Example	:OUTP:MOD OFF
Notes	This setting is for independent mode and has no effect on " List Sequencer " on page 712. If the " Sequencer " on page 713 is set to ON, the list sequencer controls the source output and this key will be grayed-out. And this setting will be none-forceful grey out on front panel to indicate out-of-scope. Non-forceful means user still can change this setting by SCPI but cannot change manually on front panel. When set to Off will make source leave list sequencer and this setting will be black out and take effect immediately. When the Modulation is ON, the "MOD" annunciator is displayed in the system settings panel. When the Modulation is turned Off, the "MOD" annunciator is cleared. If the " Sequencer " on page 713 is set to ON, the "MOD" annunciator will be replaced by "SEQ" in the system settings panel indicating that the output is controlled by list sequencer.
Preset	Off
Range	On Off
Initial S/W Revision	A.05.00

Frequency

Allows you to access the Frequency sub-menu.

Key Path	Source
Notes	The sub-menu under this button is for independent mode and has no effect on "List Sequencer" on page 712 . If the "Sequencer" on page 713 is set to ON, the list sequencer controls the source output and this key will be grayed-out. And this button will be grey out on front panel to indicate out-of-scope. When set to Off will make source leave list sequencer and this button will be black out.
Initial S/W Revision	A.05.00

Frequency

Allows you to set the RF Output Frequency. You can adjust the frequency of the source using the numeric keypad, step keys, or RPG. Pressing any digit, 0 through 9, on the numeric keypad brings up the unit terminator.

Key Path	Source, Frequency
Remote Command	:SOURce:FREQuency[:CW] <freq> :SOURce:FREQuency[:CW]?
Example	:SOUR:FREQ 1.00 GHz
Notes	Internal source has list sequence mode, which comprises of several steps which contain separate output power, frequency and waveform etc. When the source list sequence playing is complete, the last step keeps playing, and user can use this command to change the list sequence last step's output frequency.
Couplings	The frequency value is coupled to the current channel band and number, such that updates to the band and number will update the frequency value to the corresponding absolute frequency.
Preset	1.00 GHz
Min	10.00 MHz
Max	Hardware Dependant: Option 503 = 3.6 GHz Option 504 = 3.8 GHz Option 506 = 6.00 GHz
Initial S/W Revision	A.05.00

Channel

The frequency of the source can be specified by a channel number of a given frequency band. This key allows you to specify the current channel number. For the appropriate range of channel numbers for a given frequency band, refer to the following tables: **"GSM/EDGE Channel Number Ranges" on page 377**, **"W-CDMA Channel Number Ranges" on page 378**, **"CDMA 2000 / 1xEVDO Channel Number Ranges" on page 379**, and **"LTE FDD Channel Number Ranges" on page 381**.

Key Path	Source, Frequency
-----------------	--------------------------

Remote Command	:SOURce:FREQuency:CHANnels:NUMBer <int> :SOURce:FREQuency:CHANnels:NUMBer?
Example	:SOUR:FREQ:CHAN:NUMB 1
Notes	This key is grayed out when the "Radio Standard" on page 640 is set to NONE. This key is grayed out on E6630A.
Dependencies	This key is grayed out when the "Radio Standard" on page 640 is set to NONE. This key is grayed out on E6630A.
Couplings	The channel number is coupled to the frequency value when the "Radio Standard" on page 640 is not set to NONE. When the frequency value is changed, the channel number will increase or decrease to match the new frequency. If the frequency is not at an exact match for a channel number, the nearest channel number is displayed along with a greater than or less than sign to indicate the frequency is above or below the channel number.
Preset	1
Min	Please refer to the tables below for the valid ranges.
Max	Please refer to the tables below for the valid ranges.
Initial S/W Revision	A.05.00

GSM/EDGE Channel Number Ranges

Band	Link (Device)	Range	Frequency (MHz)
P-GSM	Uplink (MS)	$1 \leq n \leq 124$	$890.0 + 0.2*n$
	Downlink (BS)	$1 \leq n \leq 124$	$935.0 + 0.2*n$
E-GSM	Uplink (MS)	$0 \leq n \leq 124$	$890.0 + 0.2*n$
		$975 \leq n \leq 1023$	$890.0 + 0.2*(n-1024)$
	Downlink (BS)	$0 \leq n \leq 124$	$935.0 + 0.2*n$
		$975 \leq n \leq 1023$	$935.0 + 0.2*(n-1024)$
DCS 1800	Uplink (MS)	$512 \leq n \leq 885$	$1710.200 + 0.20*(n-512)$
	Downlink (BS)	$512 \leq n \leq 885$	$1805.200 + 0.20*(n-512)$
PCS 1900	Uplink (MS)	$512 \leq n \leq 810$	$1850.200 + 0.2*(n-512)$
	Downlink (BS)	$512 \leq n \leq 810$	$1930.200 + 0.2*(n-512)$
R-GSM	Uplink (MS)	$0 \leq n \leq 124$	$890.0 + 0.2*n$
		$955 \leq n \leq 1023$	$890.0 + 0.2*(n-1024)$
	Downlink (BS)	$0 \leq n \leq 124$	$935.0 + 0.2*n$
		$955 \leq n \leq 1023$	$935.0 + 0.2*(n-1024)$
GSM 450	Uplink (MS)	$256 \leq n \leq 293$	$450.6 + 0.2*(n-259)$
	Downlink (BS)	$256 \leq n \leq 293$	$460.6 + 0.2*(n-259)$
GSM 480	Uplink (MS)	$306 \leq n \leq 340$	$479.000 + 0.20*(n-306)$
	Downlink (BS)	$306 \leq n \leq 340$	$489.000 + 0.20*(n-306)$
GSM 850	Uplink (MS)	$128 \leq n \leq 251$	$824.200 + 0.20*(n-128)$

Band	Link (Device)	Range	Frequency (MHz)
GSM 700	Downlink (BS)	$128 \leq n \leq 251$	$869.200 + 0.20*(n-128)$
	Uplink (MS)	$438 \leq n \leq 516$	$777.200 + 0.20*(n-438)$
	Downlink (BS)	$438 \leq n \leq 516$	$747.200 + 0.20*(n-438)$
T-GSM810	Uplink (MS)	$350 \leq n \leq 425$	$806.0 + 0.20*(n-350)$
	Downlink (BS)	$350 \leq n \leq 425$	$851.0 + 0.20*(n-350)$

W-CDMA Channel Number Ranges

Band	Link (Device)	Range	Frequency (MHz)
Band I	Downlink	$10562 \leq n \leq 10838$	$n \div 5$
	Uplink	$9612 \leq n \leq 9888$	$n \div 5$
Band II	Downlink	$412 \leq n \leq 687$	$n \div 5 + 1850.1$
		$9662 \leq n \leq 9938$	$n \div 5$
	Uplink	$12 \leq n \leq 287$	$n \div 5 + 1850.1$
Band III	Downlink	$1162 \leq n \leq 1513$	$n \div 5 + 1575$
	Uplink	$937 \leq n \leq 1288$	$n \div 5 + 1525$
Band IV	Downlink	$537 \leq n \leq 1738$	$n \div 5 + 1805$
		$1887 \leq n \leq 2087$	$n \div 5 + 1735.1$
	Uplink	$1312 \leq n \leq 1513$	$n \div 5 + 1450$
Band V	Downlink	$1662 \leq n \leq 1862$	$n \div 5 + 1380.1$
		$1007 \leq n \leq 1087$	$n \div 5 + 670.1$
	Uplink	$4357 \leq n \leq 4458$	$n \div 5$
Band VI	Downlink	$782 \leq n \leq 862$	$n \div 5 + 670.1$
		$4132 \leq n \leq 4233$	$n \div 5$
	Uplink	$1037 \leq n \leq 1062$	$n \div 5 + 670.1$
Band VII	Downlink	$4387 \leq n \leq 4413$	$n \div 5$
		$812 \leq n \leq 837$	$n \div 5 + 670.1$
	Uplink	$4162 \leq n \leq 4188$	$n \div 5$
Band VIII	Downlink	$2237 \leq n \leq 2563$	$n \div 5 + 2175$
		$2587 \leq n \leq 2912$	$n \div 5 + 2105.1$
	Uplink	$2012 \leq n \leq 2338$	$n \div 5 + 2100$
Band IX	Downlink	$2362 \leq n \leq 2687$	$n \div 5 + 2030.1$
	Uplink	$2937 \leq n \leq 3088$	$n \div 5 + 340$
Band X	Downlink	$2712 \leq n \leq 2863$	$n \div 5 + 340$
	Uplink	$9237 \leq n \leq 9387$	$n \div 5$
Band XI	Downlink	$8762 \leq n \leq 8912$	$n \div 5$
	Uplink		

Band	Link (Device)	Range	Frequency (MHz)
Band X	Downlink	$3112 \leq n \leq 3388$	$n \div 5 + 1490$
		$3412 \leq n \leq 3687$	$n \div 5 + 1430.1$
	Uplink	$2887 \leq n \leq 3163$	$n \div 5 + 1135$
		$3187 \leq n \leq 3462$	$n \div 5 + 1075.1$
Band XI	Downlink	$3712 \leq n \leq 3812$	$n \div 5 + 736$
	Uplink	$3487 \leq n \leq 3587$	$n \div 5 + 733$
Band XII	Downlink	$3837 \leq n \leq 3903$	$n \div 5 - 37$
		$3927 \leq n \leq 3992$	$n \div 5 - 54.9$
	Uplink	$3612 \leq n \leq 3678$	$n \div 5 - 22$
		$3702 \leq n \leq 3767$	$n \div 5 - 39.9$
Band XIII	Downlink	$4017 \leq n \leq 4043$	$n \div 5 - 55$
		$4067 \leq n \leq 4092$	$n \div 5 - 64.9$
	Uplink	$3792 \leq n \leq 3818$	$n \div 5 + 21$
		$3702 \leq n \leq 3767$	$n \div 5 - 39.9$
Band XIV	Downlink	$4117 \leq n \leq 4143$	$n \div 5 - 63$
		$4167 \leq n \leq 4192$	$n \div 5 - 72.9$
	Uplink	$3892 \leq n \leq 3918$	$n \div 5 + 12$
		$3942 \leq n \leq 3967$	$n \div 5 + 2.1$
Band XIX	Downlink	$712 \leq n \leq 763$	$n \div 5 + 735$
		$787 \leq n \leq 837$	$n \div 5 + 720.1$
	Uplink	$312 \leq n \leq 363$	$n \div 5 + 770$
		$387 \leq n \leq 437$	$n \div 5 + 755.1$

CDMA 2000 / 1xEVDO Channel Number Ranges

Band	Link (Device)	Range	Frequency (MHz)
US Cellular	Uplink (MS, reverse link)	$1 \leq N \leq 799$	$0.030 \times N + 825.000$
		$991 \leq N \leq 1023$	$0.030 \times (N - 1023) + 825.000$
		$1024 \leq N \leq 1323$	$0.030 \times (N - 1024) + 815.040$
	Downlink (BS, forward link)	$1 \leq N \leq 799$	$0.030 \times N + 870.000$
		$991 \leq N \leq 1023$	$0.030 \times (N - 1023) + 870.000$
		$1024 \leq N \leq 1323$	$0.030 \times (N - 1024) + 860.040$
US PCS	Uplink (MS, reverse link)	$0 \leq N \leq 1199$	$1850.000 + 0.050 \times N$
	Downlink (BS, forward link)	$0 \leq N \leq 1199$	$1930.000 + 0.050 \times N$
Japan Cellular Band	Uplink (MS, reverse link)	$1 \leq N \leq 799$	$0.0125 \times (N + 915.000)$
		$801 \leq N \leq 1039$	$0.0125 \times (N - 800) + 898.000$

Band	Link (Device)	Range	Frequency (MHz)	
		$1041 \leq N \leq 1199$	$0.0125 \times (N - 1040) + 887.000$	
		$1201 \leq N \leq 1600$	$0.0125 \times (N - 1200) + 893.000$	
		Downlink (BS, forward link)	$1 \leq N \leq 799$	$0.0125 \times (N + 860.000)$
		$801 \leq N \leq 1039$	$0.0125 \times (N - 800) + 843.000$	
		$1041 \leq N \leq 1199$	$0.0125 \times (N - 1040) + 832.000$	
Korean PCS Band	Uplink (MS, reverse link)	$1201 \leq N \leq 1600$	$0.0125 \times (N - 1200) + 838.000$	
		Downlink (BS, forward link)	$0 \leq N \leq 599$	$0.050 \times N + 1750.000$
NMT-450 Band	Uplink (MS, reverse link)	$0 \leq N \leq 599$	$0.050 \times N + 1840.000$	
		$1 \leq N \leq 400$	$0.025 \times (N - 1) + 450.000$	
		$472 \leq N \leq 871$	$0.025 \times (N - 472) + 410.000$	
		$1039 \leq N \leq 1473$	$0.020 \times (N - 1024) + 451.010$	
		$1536 \leq N \leq 1715$	$0.025 \times (N - 1536) + 479.000$	
	Downlink (BS, forward link)	$1792 \leq N \leq 2016$	$0.020 \times (N - 1792) + 479.000$	
		$1 \leq N \leq 400$	$0.025 \times (N - 1) + 460.000$	
		$472 \leq N \leq 871$	$0.025 \times (N - 472) + 420.000$	
		$1039 \leq N \leq 1473$	$0.020 \times (N - 1024) + 461.010$	
		$1536 \leq N \leq 1715$	$0.025 \times (N - 1536) + 489.000$	
IMT-2000 Band	Uplink (MS, reverse link)	$1792 \leq N \leq 2016$	$0.020 \times (N - 1792) + 489.000$	
		Downlink (BS, forward link)	$0 \leq N \leq 1199$	$1920.000 + 0.050 \times N$
Upper 700 MHz Band	Uplink (MS, reverse link)	$0 \leq N \leq 1199$	$2100.000 + 0.050 \times N$	
		Downlink (BS, forward link)	$0 \leq N \leq 240$	$776.000 + 0.050 \times N$
Secondary 800 MHz Band	Uplink (MS, reverse link)	$0 \leq N \leq 240$	$746.000 + 0.050 \times N$	
		Downlink (BS, forward link)	$0 \leq N \leq 719$	$0.025 \times N + 806.000$
	Uplink (MS, reverse link)	$720 \leq N \leq 919$	$0.025 \times (N - 720) + 896.000$	
		Downlink (BS, forward link)	$0 \leq N \leq 719$	$0.025 \times N + 851.000$
2.5 GHz IMT Extension	Uplink (MS, reverse link)	$720 \leq N \leq 919$	$0.025 \times (N - 720) + 935.000$	
		Downlink (BS, forward link)	$0 \leq N \leq 1399$	$2500.000 + 0.050 \times N$
US PCS 1.9 GHz	Uplink (MS, reverse link)	$0 \leq N \leq 1399$	$2620.000 + 0.050 \times N$	
		Downlink (BS, forward link)	$0 \leq N \leq 1299$	$1850.000 + 0.050 \times N$
	Uplink (MS, reverse link)	$0 \leq N \leq 1299$	$1930.000 + 0.050 \times N$	
		Downlink (BS, forward link)		

Band	Link (Device)	Range	Frequency (MHz)
AWS	Uplink (MS, reverse link)	$0 \leq N \leq 899$	$1710.000 + 0.050 \times N$
	Downlink (BS, forward link)	$0 \leq N \leq 899$	$2100.000 + 0.050 \times N$
US 2.5 GHz	Uplink (MS, reverse link)	$140 \leq N \leq 1459$	$2495.000 + 0.050 \times N$
	Downlink (BS, forward link)	$140 \leq N \leq 1459$	$2617.000 + 0.050 \times N$
700 Public Safety	Uplink (MS, reverse link)	$0 \leq N \leq 240$	$787.000 + 0.050 \times N$
	Downlink (BS, forward link)	$0 \leq N \leq 240$	$757.000 + 0.050 \times N$
C2K Lower 700	Uplink (MS, reverse link)	$0 \leq N \leq 360$	$698.000 + 0.050 \times N$
	Downlink (BS, forward link)	$0 \leq N \leq 360$	$728.000 + 0.050 \times N$
400 Euro PAMR	Uplink (MS, reverse link)	$1 \leq N \leq 400$	$0.025 \times (N-1) + 450.000$
		$472 \leq N \leq 871$	$0.025 \times (N-472) + 410.000$
	Uplink (MS, reverse link)	$1536 \leq N \leq 1715$	$0.025 \times (N-1536) + 479.000$
	Uplink (MS, reverse link)		
	Downlink (BS, forward link)	$1 \leq N \leq 400$	$0.025 \times (N-1) + 460.000$
		$472 \leq N \leq 871$	$0.025 \times (N-472) + 420.000$
	Downlink (BS, forward link)	$1536 \leq N \leq 1715$	$0.025 \times (N-1536) + 489.000$
800 PAMR	Uplink (MS, reverse link)	$0 \leq N \leq 239$	$870.0125 + 0.025 \times N$
	Downlink (BS, forward link)	$0 \leq N \leq 239$	$915.0125 + 0.025 \times N$

LTE FDD Channel Number Ranges

The carrier frequency in the uplink and downlink is designated by the E-UTRA Absolute Radio Frequency Channel Number (EARFCN) in the range 0 – 65535. The relation between EARFCN and the carrier frequency in MHz for the downlink is given by the following equation, where FDL_low and NOffs-DL are given in table 5.4.4-1 and NDL is the downlink EARFCN.

$$FDL = FDL_low + 0.1(NDL - NOffs-DL)$$

The relation between EARFCN and the carrier frequency in MHz for the uplink is given by the following equation where FUL_low and NOffs-UL are given in table 5.4.4-1 and NUL is the uplink EARFCN.

$$FUL = FUL_low + 0.1(NUL - NOffs-UL)$$

Band	Downlink		Uplink			
	FDL_low (MHz)	NOffs-DL	Range of NDL	FUL_low (MHz)	NOffs-UL	Range of NUL
1		2110	0	0 - 599	1920	18000 - 18599
2		1930	600	600 - 1199	1850	18600 - 19199
3		1805	1200	1200 - 1949	1710	19200 - 19949
4		2110	1950	1950 - 2399	1710	19950 - 20399
5		869	2400	2400 - 2649	824	20400 - 20649
6		875	2650	2650 - 2749	830	20650 - 20749
7		2620	2750	2750 - 3449	2500	20750 - 20449
8		925	3450	3450 - 3799	880	21450 - 21799
9		1844.9	3800	3800 - 4149	1749.9	21800 - 22149
10		2110	4150	4150 - 4749	1710	22150 - 22749
11		1475.9	4750	4750 - 4949	1427.9	22750 - 22949
12		729	5010	5010 - 5179	699	23010 - 23179
13		746	5180	5180 - 5279	777	23180 - 23279
14		758	5280	5280 - 5379	788	23280 - 23379
...						
17		734	5730	5730 - 5849	704	23730 - 23849
18		860	5850	5850 - 5999	815	23850 - 23999
19		875	6000	6000 - 6149	830	24000 - 24149
20		791	6150	6150 - 6449	832	24150 -

Band	Downlink	Uplink				
						24449
21	1495.9	6450	6450 - 6599	1447.9	24450	24450 - 24599
...						
24	1525	7700	7700 - 8039	1626.5	25700	25700 - 26039
25	1930	8040	8040 - 8689	1850	26040	26040 - 26689
26	859	8690	8690 - 9039	814	26690	26690 - 27039
...						

Note: The channel numbers that designate carrier frequencies so close to the operating band edges that the carrier extends beyond the operating band edge shall not be used. This implies that the first 7, 15, 25, 50, 75 and 100 channel numbers at the lower operating band edge and the last 6, 14, 24, 49, 74 and 99 channel numbers at the upper operating band edge shall not be used for channel bandwidths of 1.4, 3, 5, 10, 15 and 20 MHz respectively.

LTE TDD Channel Number Ranges

The carrier frequency in the uplink and downlink is designated by the E-UTRA Absolute Radio Frequency Channel Number (EARFCN) in the range 0 – 65535. The relation between EARFCN and the carrier frequency in MHz for the downlink is given by the following equation, where FDL_low and NOffs-DL are given in table 5.4.4-1 and NDL is the downlink EARFCN.

$$FDL = FDL_low + 0.1(NDL - NOffs-DL)$$

The relation between EARFCN and the carrier frequency in MHz for the uplink is given by the following equation where FUL_low and NOffs-UL are given in table 5.4.4-1 and NUL is the uplink EARFCN.

$$FUL = FUL_low + 0.1(NUL - NOffs-UL)$$

Band	Downlink	Uplink				
FDL_low (MHz)	NOffs-DL	Range of ND L	FUL_low (MHz)	NOffs-UL	Range of NUL	
33	1900	36000	36000 -36199	1900	36000	36000 - 36199
34	2010	36200	36200 -36349	2010	36200	36200 - 36349
35	1850	36350	36350 -36949	1850	36350	36350 - 36949
36	1930	36950	36950 -37549	1930	36950	36950 - 37549
37	1910	37550	37550 -37749	1910	37550	37550 - 37749

Band	Downlink	Uplink				
38	2570	37750	37750 - 38249	2570	37750	37750 - 38249
39	1880	38250	38250 - 38649	1880	38250	38250 - 38649
40	2300	38650	38650 - 39649	2300	38650	38650 - 39649
41	2496	39650	39650 - 41589	2496	39650	39650 - 41589
42	3400	41590	41590 - 43589	3400	41590	41590 - 43589
43	3600	43590	43590 - 45589	3600	43590	43590 - 45589

Note: The channel numbers that designate carrier frequencies so close to the operating band edges that the carrier extends beyond the operating band edge shall not be used. This implies that the first 7, 15, 25, 50, 75 and 100 channel numbers at the lower operating band edge and the last 6, 14, 24, 49, 74 and 99 channel numbers at the upper operating band edge shall not be used for channel bandwidths of 1.4, 3, 5, 10, 15 and 20 MHz respectively.

TDSCDMA Channel Number Ranges

1.28 Mcps TDD Option

No TX-RX frequency separation is required as Time Division Duplex (TDD) is employed. Each subframe consists of 7 main timeslots where all main timeslots (at least the first one) before the single switching point are allocated DL and all main timeslots (at least the last one) after the single switching point are allocated UL.

The nominal channel spacing is 1.6 MHz, but this can be adjusted to optimise performance in a particular deployment scenario.

The carrier frequency is designated by the UTRA absolute radio frequency channel number (UARFCN). The value of the UARFCN in the IMT2000 band is defined in the general case as follows:

$$N_t = 5 * F \quad 0.0 \text{ MHz} \leq F \leq 3276.6 \text{ MHz}$$

where F is the carrier frequency in MHz

Additional channels applicable to operation in the frequency band defined in sub-clause 5.2(d) are defined via the following UARFCN definition:

$$N_t = 5 * (F - 2150.1 \text{ MHz}) \quad 2572.5 \text{ MHz} \leq F \leq 2617.5 \text{ MHz}$$

UARFCN

1.28 Mcps TDD Option

The following UARFCN range shall be supported for each band:

Table: UTRA Absolute Radio Frequency Channel Number 1.28 Mcps TDD Option

Frequency Band	Frequency Range	UARFCN Uplink and Downlink transmission
For operation in frequency band as defined in subclause 5.2 (a)	1900–1920 MHz	9504 to 9596
	2010–2025 MHz	10054 to 10121
For operation in frequency band as defined in subclause 5.2 (b)	1850–1910 MHz	9254 to 9546
	1930–1990 MHz	9654 to 9946
For operation in frequency band as defined in subclause 5.2 (c)	1910–1930 MHz	9554 to 9646
For operation in frequency band as defined in subclause 5.2 (d)	2570–2620 MHz	12854 to 13096
For operation in frequency band as defined in subclause 5.2 (e)	2300–2400 MHz	11504 to 11996
For operation in frequency band as defined in subclause 5.2 (f)	1880–1920 MHz	9404 to 9596

Radio Setup

Allows access to the sub-menus for selecting the radio standard and associated radio band. You can also set a frequency reference and offset.

This menu is greyed out when on E6630A. Radio band settings for GSM, cdma2000, and so on -- most of which are not actually supported in E6630A, which has three narrow frequency bands. So band settings are grayed out.

Key Path	Source, Frequency
Initial S/W Revision	A.05.00

Radio Standard

Allows access to the channel band sub-menus to select the desired radio standard. When you have selected the radio standard, you can then set an active channel band. The radio standard and the active channel band allow you to use channel numbers to set frequency automatically.

Key Path	Source, Frequency, Radio Setup
Remote Command	:SOURce:FREQuency:CHANnels:BAND NONE PGSM EGSM RGSM DCS1800 PCS1900 TGSM810 GSM450 GSM480 GSM700 GSM850 BANDI BANDII BANDIII BANDIV BANDV BANDVI BANDVII BANDVIII BANDIX BANDX BANDXI BANDXII BANDXIII BANDXIV BANDXIX USCELL USPCS JAPAN KOREAN NMT IMT2K UPPER SECOND PAMR400 PAMR800 IMTEXT PCS1DOT9G AWS US2DOT5G PUBLIC LOWER BAND1 BAND2 BAND3 BAND4 BAND5 BAND6 BAND7 BAND8 BAND10

BAND11 | BAND12 | BAND13 | BAND14 | BAND17 | BAND18 | BAND19 | BAND20 |
 BAND21 | BAND24 | BAND25 | BAND26 | BAND27 | BAND28 | BAND29 | BAND30 |
 BAND31 | BAND33 | BAND34 | BAND35 | BAND36 | BAND37 | BAND38 | BAND39 |
 BAND40 | BAND41 | BAND42 | BAND43 | BAND44 | BANDA | BANDB | BANDC |
 BANDD | BANDE | BANDF

:SOURce:FREQuency:CHANnels:BAND?

Example	:SOUR:FREQ:CHAN:BAND PGSM
Notes	Set this setting to "NONE" will grey out "Channel" on page 631 Channel
Initial S/W Revision	A.05.00

None

Selects no radio standard for use. When you have selected the radio standard to NONE, you cannot use channel numbers to set frequency automatically. You will need to set the frequency manually.

Key Path	Source, Frequency, Radio Setup, Radio Standard
Initial S/W Revision	A.05.00

GSM/EDGE

Sets GSM/EDGE as the radio standard for use and accesses the GSM/EDGE specific channel band sub-menus.

Key Path	Source, Frequency, Radio Setup, Radio Standard
Initial S/W Revision	A.05.00

P-GSM

Selects P-GSM as the active channel band.

Key Path	Source, Frequency, Radio Setup, Radio Standard, GSM/EDGE
Example	:SOUR:FREQ:CHAN:BAND PGSM
Initial S/W Revision	A.05.00

E-GSM

Selects E-GSM as the active channel band.

Key Path	Source, Frequency, Radio Setup, Radio Standard, GSM/EDGE
Example	:SOUR:FREQ:CHAN:BAND EGSM
Initial S/W Revision	A.05.00

R-GSM

Selects R-GSM as the active channel band.

Key Path	Source, Frequency, Radio Setup, Radio Standard, GSM/EDGE
Example	:SOUR:FREQ:CHAN:BAND RGSM
Initial S/W Revision	A.05.00

DCS 1800

Selects DCS 1800 as the active channel band.

Key Path	Source, Frequency, Radio Setup, Radio Standard, GSM/EDGE
Example	:SOUR:FREQ:CHAN:BAND DCS1800
Initial S/W Revision	A.05.00

PCS 1900

Selects PCS 1900 as the active channel band.

Key Path	Source, Frequency, Radio Setup, Radio Standard, GSM/EDGE
Example	:SOUR:FREQ:CHAN:BAND PCS1900
Initial S/W Revision	A.05.00

GSM 450

Selects GSM 450 as the active channel band.

Key Path	Source, Frequency, Radio Setup, Radio Standard, GSM/EDGE
Example	:SOUR:FREQ:CHAN:BAND GSM450
Initial S/W Revision	A.05.00

GSM 480

Selects GSM 480 as the active channel band.

Key Path	Source, Frequency, Radio Setup, Radio Standard, GSM/EDGE
Example	:SOUR:FREQ:CHAN:BAND GSM480
Initial S/W Revision	A.05.00

GSM 850

Selects GSM 850 as the active channel band.

Key Path	Source, Frequency, Radio Setup, Radio Standard, GSM/EDGE
Example	:SOUR:FREQ:CHAN:BAND GSM850
Initial S/W Revision	A.05.00

GSM 700

Selects GSM 700 as the active channel band.

Key Path	Source, Frequency, Radio Setup, Radio Standard, GSM/EDGE
Example	:SOUR:FREQ:CHAN:BAND GSM700
Initial S/W Revision	A.05.00

T-GSM 810

Selects T-GSM 810 as the active channel band.

Key Path	Source, Frequency, Radio Setup, Radio Standard, GSM/EDGE
Example	:SOUR:FREQ:CHAN:BAND T-GSM810
Initial S/W Revision	A.05.00

WCDMA

Sets WCDMA as the radio standard for use and accesses the W-CDMA specific channel band sub-menus.

Key Path	Source, Frequency, Radio Setup, Radio Standard
Initial S/W Revision	A.05.00

Band I

Selects Band I as the active channel band.

Key Path	Source, Frequency, Radio Setup, Radio Standard, WCDMA
Example	:SOUR:FREQ:CHAN:BAND BANDI
Initial S/W Revision	A.05.00

Band II

Selects Band II as the active channel band.

Key Path	Source, Frequency, Radio Setup, Radio Standard, WCDMA
Example	:SOUR:FREQ:CHAN:BAND BANDII
Initial S/W Revision	A.05.00

Band III

Selects Band III as the active channel band.

Key Path	Source, Frequency, Radio Setup, Radio Standard, WCDMA
Example	:SOUR:FREQ:CHAN:BAND BANDIII
Initial S/W Revision	A.05.00

Band IV

Selects Band IV as the active channel band.

Key Path	Source, Frequency, Radio Setup, Radio Standard, WCDMA
Example	:SOUR:FREQ:CHAN:BAND BANDIV
Initial S/W Revision	A.05.00

Band V

Selects Band V as the active channel band.

Key Path	Source, Frequency, Radio Setup, Radio Standard, WCDMA
Example	:SOUR:FREQ:CHAN:BAND BANDV
Initial S/W Revision	A.05.00

Band VI

Selects Band VI as the active channel band.

Key Path	Source, Frequency, Radio Setup, Radio Standard, WCDMA
Example	:SOUR:FREQ:CHAN:BAND BANDVI
Initial S/W Revision	A.05.00

Band VII

Selects Band VII as the active channel band.

Key Path	Source, Frequency, Radio Setup, Radio Standard, WCDMA
Example	:SOUR:FREQ:CHAN:BAND BANDVII
Initial S/W Revision	A.05.00

Band VIII

Selects Band VIII as the active channel band.

Key Path	Source, Frequency, Radio Setup, Radio Standard, WCDMA
Example	:SOUR:FREQ:CHAN:BAND BANDVIII
Initial S/W Revision	A.05.00

Band IX

Selects Band IX as the active channel band.

Key Path	Source, Frequency, Radio Setup, Radio Standard, WCDMA
Example	:SOUR:FREQ:CHAN:BAND BANDIX
Initial S/W Revision	A.05.00

Band X

Selects Band X as the active channel band.

Key Path	Source, Frequency, Radio Setup, Radio Standard, WCDMA
Example	:SOUR:FREQ:CHAN:BAND BANDX
Initial S/W Revision	A.05.00

Band XI

Selects Band XI as the active channel band.

Key Path	Source, Frequency, Radio Setup, Radio Standard, WCDMA
Example	:SOUR:FREQ:CHAN:BAND BANDXI
Initial S/W Revision	A.05.00

Band XII

Selects Band XII as the active channel band.

Key Path	Source, Frequency, Radio Setup, Radio Standard, WCDMA
Example	:SOUR:FREQ:CHAN:BAND BANDXII
Initial S/W Revision	A.05.00

Band XIII

Selects band XIII as the active channel band.

Key Path	Source, Frequency, Radio Setup, Radio Standard, WCDMA
Example	:SOUR:FREQ:CHAN:BAND BANDXIII
Initial S/W Revision	A.05.00

Band XIV

Selects Band XIV as the active channel band.

Key Path	Source, Frequency, Radio Setup, Radio Standard, WCDMA
Example	:SOUR:FREQ:CHAN:BAND BANDXIV
Initial S/W Revision	A.05.00

CDMA 2000 / 1xEVDO

Sets CDMA 2000 / 1XEVDO as the radio standard for use and accesses the CDMA 2000/1xEVDO specific channel band sub-menus.

Key Path	Source, Frequency, Radio Setup, Radio Standard
Initial S/W Revision	A.05.00

US CELL

Selects US Cell as the active channel band.

Key Path	Source, Frequency, Radio Setup, Radio Standard, CDMA 2000 / 1xEVDO
Example	:SOUR:FREQ:CHAN:BAND USCELL
Initial S/W Revision	A.05.00

US PCS

Selects US PCS as the active channel band.

Key Path	Source, Frequency, Radio Setup, Radio Standard, CDMA 2000 / 1xEVDO
Example	:SOUR:FREQ:CHAN:BAND PCS
Initial S/W Revision	A.05.00

Japan Cell

Selects Japan Cell as the active channel band.

Key Path	Source, Frequency, Radio Setup, Radio Standard, CDMA 2000 / 1xEVDO
Example	:SOUR:FREQ:CHAN:BAND JAPAN
Initial S/W Revision	A.05.00

Korean PCS

Selects Korean PCS as the active channel band.

Key Path	Source, Frequency, Radio Setup, Radio Standard, CDMA 2000 / 1xEVDO
Example	:SOUR:FREQ:CHAN:BAND KOREAN
Initial S/W Revision	A.05.00

NMT 450

Selects NMT 450 as the active channel band.

Key Path	Source, Frequency, Radio Setup, Radio Standard, CDMA 2000 / 1xEVDO
Example	:SOUR:FREQ:CHAN:BAND NMT
Initial S/W Revision	A.05.00

IMT 2000

Selects IMT 2000 as the active channel band.

Key Path	Source, Frequency, Radio Setup, Radio Standard, CDMA 2000 / 1xEVDO
Example	:SOUR:FREQ:CHAN:BAND IMT2K
Initial S/W Revision	A.05.00

Upper 700

Selects Upper 700 as the active channel band.

Key Path	Source, Frequency, Radio Setup, Radio Standard, CDMA 2000 / 1xEVDO
Example	:SOUR:FREQ:CHAN:BAND UPPER
Initial S/W Revision	A.05.00

Secondary 800

Selects Secondary 800 as the active channel band.

Key Path	Source, Frequency, Radio Setup, Radio Standard, CDMA 2000 / 1xEVDO
Example	:SOUR:FREQ:CHAN:BAND SECOND
Initial S/W Revision	A.05.00

400 Euro PAMR

Selects 400 Euro PAMR as the active channel band.

Key Path	Source, Frequency, Radio Setup, Radio Standard, CDMA 2000 / 1xEVDO
Example	:SOUR:FREQ:CHAN:BAND PAMR400
Initial S/W Revision	A.05.00

800 PAMR

Selects 800 PAMR as the active channel band.

Key Path	Source, Frequency, Radio Setup, Radio Standard, CDMA 2000 / 1xEVDO
Example	:SOUR:FREQ:CHAN:BAND PAMR800
Initial S/W Revision	A.05.00

2.5GHz IMT EXT

Selects 2.5 GHz IMT EXT as the active channel band.

Key Path	Source, Frequency, Radio Setup, Radio Standard, CDMA 2000 / 1xEVDO
Example	:SOUR:FREQ:CHAN:BAND IMTEXT
Initial S/W Revision	A.05.00

US PCS 1.9GHz

Selects US PCS 1.9 GHz as the active channel band.

Key Path	Source, Frequency, Radio Setup, Radio Standard, CDMA 2000 / 1xEVDO
Example	:SOUR:FREQ:CHAN:BAND PCS1DOT9G
Initial S/W Revision	A.05.00

AWS

Selects AWS as the active channel band.

Key Path	Source, Frequency, Radio Setup, Radio Standard, CDMA 2000 / 1xEVDO
Example	:SOUR:FREQ:CHAN:BAND AWS
Initial S/W Revision	A.05.00

US 2.5GHz

Selects US 2.5 GHz as the active channel band.

Key Path	Source, Frequency, Radio Setup, Radio Standard, CDMA 2000 / 1xEVDO
Example	:SOUR:FREQ:CHAN:BAND US2DOT5G
Initial S/W Revision	A.05.00

700 Public Safety

Selects 700 Public Safety as the active channel band.

Key Path	Source, Frequency, Radio Setup, Radio Standard, CDMA 2000 / 1xEVDO
Example	:SOUR:FREQ:CHAN:BAND PUBLIC
Initial S/W Revision	A.05.00

C2K Lower 700

Selects C2K Lower 700 as the active channel band.

Key Path	Source, Frequency, Radio Setup, Radio Standard, CDMA 2000 / 1xEVDO
Example	:SOUR:FREQ:CHAN:BAND LOWER
Initial S/W Revision	A.05.00

LTE

Sets LTE FDD as the radio standard for use and accesses the LTE FDD specific channel band sub-menus..

Key Path	Source, Frequency, Radio Setup, Radio Standard
Initial S/W Revision	A.09.50

BAND 1

Selects BAND 1 as the band for the current step.

Key Path	Source, Frequency, Radio Setup, Radio Standard, LTE
Example	:SOUR:FREQ:CHAN:BAND BAND1
Initial S/W Revision	A.09.50

BAND 2

Selects BAND 2 as the band for the current step.

Key Path	Source, Frequency, Radio Setup, Radio Standard, LTE
Example	:SOUR:FREQ:CHAN:BAND BAND2
Initial S/W Revision	A.09.50

BAND 3

Selects BAND 3 as the band for the current step.

Key Path	Source, Frequency, Radio Setup, Radio Standard, LTE
Example	:SOUR:FREQ:CHAN:BAND BAND3
Initial S/W Revision	A.09.50

BAND 4

Selects BAND 4 as the band for the current step.

Key Path	Source, Frequency, Radio Setup, Radio Standard, LTE
Example	:SOUR:FREQ:CHAN:BAND BAND4
Initial S/W Revision	A.09.50

BAND 5

Selects BAND 5 as the band for the current step.

Key Path	Source, Frequency, Radio Setup, Radio Standard, LTE
----------	--

Example	:SOUR:FREQ:CHAN:BAND BAND5
Initial S/W Revision	A.09.50

BAND 6

Selects BAND 6 as the band for the current step.

Key Path	Source, Frequency, Radio Setup, Radio Standard, LTE
Example	:SOUR:FREQ:CHAN:BAND BAND6
Initial S/W Revision	A.09.50

BAND 7

Selects BAND 7 as the band for the current step.

Key Path	Source, Frequency, Radio Setup, Radio Standard, LTE
Example	:SOUR:FREQ:CHAN:BAND BAND7
Initial S/W Revision	A.09.50

BAND 8

Selects BAND 8 as the band for the current step.

Key Path	Source, Frequency, Radio Setup, Radio Standard, LTE
Example	:SOUR:FREQ:CHAN:BAND BAND8
Initial S/W Revision	A.09.50

BAND 9

Selects BAND 9 as the band for the current step.

Key Path	Source, Frequency, Radio Setup, Radio Standard, LTE
Example	:SOUR:FREQ:CHAN:BAND BAND9
Initial S/W Revision	A.09.50

BAND 10

Selects BAND 10 as the band for the current step.

Key Path	Source, Frequency, Radio Setup, Radio Standard, LTE
----------	--

Example	:SOUR:FREQ:CHAN:BAND BAND10
Initial S/W Revision	A.09.50

BAND 11

Selects BAND 11 as the band for the current step.

Key Path	Source, Frequency, Radio Setup, Radio Standard, LTE
Example	:SOUR:FREQ:CHAN:BAND BAND11
Initial S/W Revision	A.09.50

BAND 12

Selects BAND 12 as the band for the current step.

Key Path	Source, Frequency, Radio Setup, Radio Standard, LTE
Example	:SOUR:FREQ:CHAN:BAND BAND12
Initial S/W Revision	A.09.50

BAND 13

Selects BAND 13 as the band for the current step.

Key Path	Source, Frequency, Radio Setup, Radio Standard, LTE
Example	:SOUR:FREQ:CHAN:BAND BAND13
Initial S/W Revision	A.09.50

BAND 14

Selects BAND 14 as the band for the current step.

Key Path	Source, Frequency, Radio Setup, Radio Standard, LTE
Example	:SOUR:FREQ:CHAN:BAND BAND14
Initial S/W Revision	A.09.50

BAND 17

Selects BAND 17 as the band for the current step.

Key Path	Source, Frequency, Radio Setup, Radio Standard, LTE
----------	--

Example	:SOUR:FREQ:CHAN:BAND BAND17
Initial S/W Revision	A.09.50

BAND 18

Selects BAND 18 as the band for the current step.

Key Path	Source, Frequency, Radio Setup, Radio Standard, LTE
Example	:SOUR:FREQ:CHAN:BAND BAND18
Initial S/W Revision	A.09.50

BAND 19

Selects BAND 19 as the band for the current step.

Key Path	Source, Frequency, Radio Setup, Radio Standard, LTE
Example	:SOUR:FREQ:CHAN:BAND BAND19
Initial S/W Revision	A.09.50

BAND 20

Selects BAND 20 as the band for the current step.

Key Path	Source, Frequency, Radio Setup, Radio Standard, LTE
Example	:SOUR:FREQ:CHAN:BAND BAND20
Initial S/W Revision	A.09.50

BAND 21

Selects BAND 21 as the band for the current step.

Key Path	Source, Frequency, Radio Setup, Radio Standard, LTE
Example	:SOUR:FREQ:CHAN:BAND BAND21
Initial S/W Revision	A.09.50

BAND 24

Selects BAND 24 as the band for the current step.

Key Path	Source, Frequency, Radio Setup, Radio Standard, LTE
----------	--

Example	:SOUR:FREQ:CHAN:BAND BAND24
Initial S/W Revision	A.09.50

BAND 25

Selects BAND 25 as the band for the current step.

Key Path	Source, Frequency, Radio Setup, Radio Standard, LTE
Example	:SOUR:FREQ:CHAN:BAND BAND25
Initial S/W Revision	A.09.50

BAND 26

Selects BAND 26 as the band for the current step.

Key Path	Source, Frequency, Radio Setup, Radio Standard, LTE
Example	:SOUR:FREQ:CHAN:BAND BAND26
Initial S/W Revision	A.12.53

BAND 27

Selects BAND 27 as the band for the current step.

Key Path	Source, Frequency, Radio Setup, Radio Standard, LTE
Example	:SOUR:FREQ:CHAN:BAND BAND27
Initial S/W Revision	A.14.00

BAND 28

Selects BAND 28 as the band for the current step.

Key Path	Source, Frequency, Radio Setup, Radio Standard, LTE
Example	:SOUR:FREQ:CHAN:BAND BAND28
Initial S/W Revision	A.14.00

BAND 31

Selects BAND 31 as the band for the current step.

Key Path	Source, Frequency, Radio Setup, Radio Standard, LTE
----------	--

Example	:SOUR:FREQ:CHAN:BAND BAND31
Initial S/W Revision	A.14.00

LTE TDD

Sets LTE TDD as the radio standard for use and accesses the LTE TDD specific channel band sub-menus..

Key Path	Source, Frequency, Radio Setup, Radio Standard
Initial S/W Revision	A.11.50

BAND 33

Selects BAND 33 as the band for the current step.

Key Path	Source, Frequency, Radio Setup, Radio Standard, LTE TDD
Example	:SOUR:FREQ:CHAN:BAND BAND33
Initial S/W Revision	A.11.50

BAND 34

Selects BAND 34 as the band for the current step.

Key Path	Source, Frequency, Radio Setup, Radio Standard, LTE TDD
Example	:SOUR:FREQ:CHAN:BAND BAND34
Initial S/W Revision	A.11.50

BAND 35

Selects BAND 35 as the band for the current step.

Key Path	Source, Frequency, Radio Setup, Radio Standard, LTE TDD
Example	:SOUR:FREQ:CHAN:BAND BAND35
Initial S/W Revision	A.11.50

BAND 36

Selects BAND 36 as the band for the current step.

Key Path	Source, Frequency, Radio Setup, Radio Standard, LTE TDD
Example	:SOUR:FREQ:CHAN:BAND BAND36
Initial S/W Revision	A.11.50

BAND 37

Selects BAND 37 as the band for the current step.

Key Path	Source, Frequency, Radio Setup, Radio Standard, LTE TDD
Example	:SOUR:FREQ:CHAN:BAND BAND37
Initial S/W Revision	A.11.50

BAND 38

Selects BAND 38 as the band for the current step.

Key Path	Source, Frequency, Radio Setup, Radio Standard, LTE TDD
Example	:SOUR:FREQ:CHAN:BAND BAND38
Initial S/W Revision	A.11.50

BAND 39

Selects BAND 39 as the band for the current step.

Key Path	Source, Frequency, Radio Setup, Radio Standard, LTE TDD
Example	:SOUR:FREQ:CHAN:BAND BAND39
Initial S/W Revision	A.11.50

BAND 40

Selects BAND 40 as the band for the current step.

Key Path	Source, Frequency, Radio Setup, Radio Standard, LTE TDD
Example	:SOUR:FREQ:CHAN:BAND BAND40
Initial S/W Revision	A.11.50

BAND 41

Selects BAND 41 as the band for the current step.

Key Path	Source, Frequency, Radio Setup, Radio Standard, LTE TDD
Example	:SOUR:FREQ:CHAN:BAND BAND41
Initial S/W Revision	A.11.50

BAND 42

Selects BAND 42 as the band for the current step.

Key Path	Source, Frequency, Radio Setup, Radio Standard, LTE TDD
Example	:SOUR:FREQ:CHAN:BAND BAND42
Initial S/W Revision	A.11.50

BAND 43

Selects BAND 43 as the band for the current step.

Key Path	Source, Frequency, Radio Setup, Radio Standard, LTE TDD
Example	:SOUR:FREQ:CHAN:BAND BAND43
Initial S/W Revision	A.11.50

BAND 44

Selects BAND 44 as the band for the current step.

Key Path	Source, Frequency, Radio Setup, Radio Standard, LTE TDD
Example	:SOUR:FREQ:CHAN:BAND BAND44
Initial S/W Revision	A.14.00

TDSCDMA

Sets TDSCDMA as the radio standard for use and accesses the TDSCDMA specific channel band sub-menus..

Key Path	Source, Frequency, Radio Setup, Radio Standard
Initial S/W Revision	A.11.50

BAND A

Selects BAND A as the band for the current step.

Key Path	Source, Frequency, Radio Setup, Radio Standard, TDSCDMA
Example	:SOUR:FREQ:CHAN:BAND BANDA
Initial S/W Revision	A.11.50

BAND B

Selects BAND B as the band for the current step.

Key Path	Source, Frequency, Radio Setup, Radio Standard, TDSCDMA
Example	:SOUR:FREQ:CHAN:BAND BANDB
Initial S/W Revision	A.11.50

BAND C

Selects BAND C as the band for the current step.

Key Path	Source, Frequency, Radio Setup, Radio Standard, TDSCDMA
Example	:SOUR:FREQ:CHAN:BAND BANDC
Initial S/W Revision	A.11.50

BAND D

Selects BAND D as the band for the current step.

Key Path	Source, Frequency, Radio Setup, Radio Standard, TDSCDMA
Example	:SOUR:FREQ:CHAN:BAND BANDD
Initial S/W Revision	A.11.50

BAND E

Selects BAND E as the band for the current step.

Key Path	Source, Frequency, Radio Setup, Radio Standard, TDSCDMA
Example	:SOUR:FREQ:CHAN:BAND BANDE
Initial S/W Revision	A.11.50

BAND F

Selects BAND F as the band for the current step.

Key Path	Source, Frequency, Radio Setup, Radio Standard, TDSCDMA
Example	:SOUR:FREQ:CHAN:BAND BANDF
Initial S/W Revision	A.11.50

Radio Band Link

Allows you to specify the channel band type as either uplink or downlink link direction. This value is used in conjunction with the channel band and channel number to determine the absolute frequency output by the

source. When set to “Uplink”, the source will calculate the uplink frequency using an uplink formula together with the selected channel band and channel number . When set to “Downlink”, the source will calculate the downlink frequency using a downlink formula together with the selected channel band and channel number.

Key Path	Source, Frequency, Radio Setup
Remote Command	:SOURce:RADio:BAND:LINK DOWN UP :SOURce:RADio:BAND:LINK?
Example	:SOUR:RAD:BAND:LINK UP
Preset	DOWN
Range	DOWN UP
Backwards Compatibility SCPI	:SOURce:RADio:DEVIce BTS MS :SOURce:RADio:DEVIce?
Backwards Compatibility Notes	BTS maps to the Downlink frequency MS maps to the Uplink frequency
Initial S/W Revision	A.05.00

Set Reference Frequency

This key allows you to set the frequency reference. Pressing this key turns the frequency reference state to ON, sets the reference frequency value to the current frequency, maintains this frequency at the RF output, and sets the displayed frequency to 0.00 Hz. All subsequent frequencies entered under Source>Frequency>Frequency are interpreted as being relative to this reference frequency.

When you use a frequency reference, the signal generator outputs a frequency that is set relative to the reference frequency by the value entered under Source>Frequency>Frequency as follows:

$$\text{Output frequency} = \text{reference frequency} - \text{entered frequency}$$

Where:

reference frequency equals the original RF frequency entered under Source>Frequency>Frequency and set as the reference frequency

entered frequency equals a new value entered under Source>Frequency>Frequency

In addition, the displayed frequency value will be the same as the value entered under Source>Frequency>Frequency.

NOTE

If Freq Reference is set to ON with a reference value set, entering a value under Source>Frequency>Frequency and pressing Set Frequency Reference will add that value to the existing Freq Reference value.

If you wish to change the reference frequency value to the new value entered under Source>Frequency>Frequency, first you must set Freq Reference to OFF and then press Set Frequency Reference.

Key Path	Source, Frequency
-----------------	--------------------------

Remote Command	:SOURce:FREQuency:REFerence:SET
Example	:SOUR:FREQ:REF:SET
Dependencies	This setting is unavailable, and is grayed out when the List Sequencer is turned ON.
Initial S/W Revision	A.05.00

Freq Reference

This key allows you to toggle the state of the frequency reference. When the frequency reference state is ON, an annunciator is displayed on the main source view to indicate this state to the user.

When you use a frequency reference, the signal generator outputs a frequency that is set relative to the reference frequency by the value entered under Source>Frequency>Frequency as follows:

Output frequency = reference frequency + entered frequency

Where:

reference frequency equals the original RF frequency entered under Source>Frequency>Frequency and set as the reference frequency

entered frequency equals a new value entered under Source>Frequency>Frequency

For more information on Reference Frequency refer to ["Set Reference Frequency" on page 659](#)

Key Path	Source, Frequency
Remote Command	:SOURce:FREQuency:REFerence <freq> :SOURce:FREQuency:REFerence? :SOURce:FREQuency:REFerence:STATe OFF ON 0 1 :SOURce:FREQuency:REFerence:STATe?
Example	:SOUR:FREQ:REF 0.00 Hz :SOUR:FREQ:REF:STATe ON
Dependencies	This setting is unavailable, and is grayed out when the List Sequencer is turned ON.
Couplings	The frequency reference state is coupled to the frequency reference set immediate action. When the reference set immediate action key is pressed, or the SCPI command issued, it turns the frequency reference state ON.
Preset	0.00 Hz OFF
Min	0.00 Hz
Max	Hardware Dependant: Option 503 = 3.6 GHz Option 504 = 3.8 GHz Option 506 = 6.00 GHz
Initial S/W Revision	A.05.00

Freq Offset

Allows you to specify the frequency offset value. When the frequency offset state is ON, an annunciator is displayed on the main source view to indicate this state to the user.

When the frequency offset is set to zero (0) and you set a new offset value, the displayed frequency value will change as follows and the RF output frequency will not change:

Displayed value = output frequency + offset value

Where:

output frequency equals the original frequency entered under Source > Frequency > Frequency

offset value equals the value entered under Source > Frequency > Freq Offset

When the frequency offset is set to a value other than zero (0) and you enter a new frequency value under Source > Frequency > Frequency, the displayed frequency will be the same as the value entered and the RF output frequency will be equal to the value entered minus the offset value as follows:

Output frequency = entered frequency – offset frequency

Displayed frequency = output frequency + offset frequency

Displayed frequency = entered frequency

Where:

entered frequency equals the frequency entered under Source > Frequency > Frequency

offset frequency equals the value previously entered and set under Source > Frequency > Freq Offset

Key Path	Source, Frequency
Remote Command	:SOURce:FREQuency:OFFSet <freq> :SOURce:FREQuency:OFFSet?
Example	:SOUR:FREQ:OFFS 0 Hz
Dependencies	This setting is unavailable, and is grayed out when the List Sequencer is turned ON.
Preset	0 Hz
Min	-100.00 GHz
Max	100.00 GHz
Initial S/W Revision	A.05.00

Modulation Setup

Allows access to the menus for setting up the available modulation types: "ARB" on page 662, "AM" on page 708, "FM" on page 710, and "PM" on page 711.

Key Path	Source
Initial S/W Revision	A.05.00

ARB

Allows you access to the ARB sub-menus.

Key Path	Source, Modulation Setup
Initial S/W Revision	A.05.00

ARB

Allows you to toggle the state of the ARB function. When the ARB is On, a “MOD” annunciator is displayed in the system settings panel. When the ARB is turned Off, the MOD annunciator is cleared

Key Path	Source, Modulation Setup, ARB
Remote Command	:SOURce:RADio:ARB[:STATe] ON OFF 1 0 :SOURce:RADio:ARB[:STATe]?
Example	:SOUR:RAD:ARB OFF :SOUR:RAD:ARB?
Notes	If the ARB is ON, a user then loads or deletes another file to ARB memory, the playing waveform segment may not keep phase continuity during the ARB memory operation. The waveform will be replayed after the ARB operation is finished.
Dependencies	This setting is for independent mode and has no effect on 3.3.8 list sequencer mode. Setting "Sequencer" on page 713 Sequencer to On will put source enter list sequencer mode, and even if ARB state is On, the ARB file will not be played. Setting "Sequencer" on page 713 Sequencer to Off will make source leave list sequencer mode, and this setting will take effect immediately. The ARB can only be turned on when there is a waveform file selected for playback. On the GUI If no waveform is selected, this key is grayed out. If you send the SCPI command to turn the ARB on with no waveform selected for playback, the ARB state remains OFF and an error is generated. "- When you try to recall a certain set of states in which the selected waveform is not in ARB memory and the ARB state is On, errors are reported
Couplings	If "Real-Time AWGN" on page 673 AWGN State is On and this setting is On, "RF Power" on page 627 RF Power will be adjusted to the value to maintain the AWGN power relationship defined by "Power Control Mode" on page 674 Power Control Mode and other noise settings
Preset	Off
Range	On Off
Initial S/W Revision	A.05.00
Modified at S/W Revision	A.16.00 (Add couplings with AWGN state)

Select Waveform

Allows you to access to the waveform selection sub-menus.

Pressing this key changes the central view area to show the Waveform File Selection view.

Key Path	Source, Modulation Setup, ARB
Initial S/W Revision	A.05.00

Select Waveform

Allows you to select a waveform sequence or segment for the dual ARB to play.

Key Path	Source, Modulation Setup, ARB, Select Waveform
Remote Command	:SOURce:RADio:ARB:WAVeform <string> :SOURce:RADio:ARB:WAVeform?
Example	:SOUR:RAD:ARB:WAV "test_waveform.bin"
Notes	<p>If intended waveform is not in the memory yet, then issuing this command by SCPI will invoke ARB loading operation first, which involves a delay of unpredictable length. So this command should be followed by the query *OPC?, which holds off subsequent commands until the loading operating is complete.</p> <p><string> - specifies the name of the waveform segment or waveform sequence to be played by the ARB.</p> <p>When in Sequence Analyzer mode, and Include Source is Yes, if the you attempt to play a waveform sequence but not all the required waveform segments are in the ARB playback memory, the application will reject the loading operation with an error is generated .</p> <p>When Include Source is No, if you attempt to play a waveform sequence but not all the required waveform segments are contained in the ARB playback memory, the application will attempt to load the required segments from either the default directory of the current directory. If the ARB memory does not have enough space for all the waveform segments to be loaded, an error is generated and none of the waveform segments is loaded.</p> <p>If the ARB is ON, and you attampt to play a waveform sequence but not all the waveform segments within the sequence could be found to be loaded into ARB memory, an error is generated. The selected waveform keeps the previous value and ARB state remains On.</p> <p>If you specify a waveform segment over SCPI but the waveform segment is not present within ARB playback memory and cannot be found for auto loading within the current directory or the default directory, an error is generatedand the file selection remains unchanged.</p> <p>If you select a waveform for playback and the waveform requires a license that is not installed on the instrument, an error is generated.error is generated.</p> <p>If the ARB is ON and you load a file to ARB memory or delete a file from ARB memory, the playing waveform segment may not keep phase continuity during the ARB memory operation. The waveform will be replayed after the ARB operation is finished.</p>
Initial S/W Revision	A.05.00

Segments on Hard Disk

Allows you access to the sub-menus for loading waveform segments from the hard disk into ARB memory. The default directory is: D: varb.

Pressing this key changes the current view to the Waveform Management View.

Key Path	Source, Modulation Setup, ARB, Select Waveform
Initial S/W Revision	A.05.00

Load Segment To ARB Memory

Allows you to load the selected file into ARB memory. On the front panel you select the file for loading to the ARB memory by highlighting the desired file in the list. Using the SCPI command, you specify the file name on the HDD.

“NVWFM” (none-volatile storage) MSUS (Mass Storage Unit Specifier) is supported in the memory subsystem because the ARB memory cannot be accessed directly. Therefore, files must be downloaded to the instrument hard disk and then loaded into the ARB memory. “NVWFM” MSUS will be mapped to the default directory D: VARB. The SCPI command supports using either “NVWFM” MSUS or specifying a full path. For more information, see [Memory Subsystem \(Remote Command Only\)](#).

If a file of the same name already exists within ARB memory, it is overwritten. If you wish to load two segments of the same name, you must rename one of the segments before loading it into ARB memory. To rename a segment, you can either use Windows File Explorer, or the :MMEMory:COPI command.

Key Path	Source, Modulation Setup, ARB, Select Waveform, Segments on Hard Disk
Remote Command	:SOURce:RADio:ARB:LOAD <string>
Example	:SOUR:RAD:ARB:LOAD "D: VARB\testwaveform.bin" or :SOUR:RAD:ARB:LOAD "NVWFM:testwaveform.bin"
Notes	<p>Because loading the file involves a delay of unpredictable length, this command should be followed by the query *OPC?, which holds off subsequent commands until the loading operating is complete.</p> <p><string> – specifies the path name of the file to load from the HDD into ARB memory. It could be a <full path + filename>, or <“NVWFM” MSUS + colon + filename>.</p> <p>When in Sequence Analyzer mode, and Include Source is Yes, an attempt to load a file to ARB memory will be rejected with an error.</p> <p>When Include Source is No and if there is insufficient free ARB memory to load the selected waveform, an error is generated. .</p> <p>If you specify a file over SCPI, but the file is not at the specified location, an error is generated.</p> <p>If you try to load a waveform file but the file contains less than 500 IQ samples, an error is generated.</p> <p>If you try to load a Signal Studio waveform “*.wfm” which contains invalid waveform header, an error is generated.</p> <p>If the ARB is ON when you load a file to ARB memory or delete a file from ARB memory, the playing waveform segment may not keep phase continuity during the ARB memory operation. The waveform will be replayed after the ARB operation is finished.</p> <p>ARB can be loaded into ARB memory even required licenses do not present on the instrument. In this</p>

case, a GUI only warning message -800, "Operation complete; Loaded <filename> successfully, but no license <required licenses> installed". User can install required licenses according to <required licenses> string to license it, or multi-pack license it.

Initial S/W Revision A.05.00

Load All To ARB Memory

Allows you to load all the segment files within the currently selected directory into ARB memory. If a file of the same name already exists within ARB memory, it is overwritten. If you wish to load two segments of the same name, you must rename one of the segments before loading it into ARB memory. To rename a segment, you can either use Windows File Explorer, or the :MEMory:COPY command.

Key Path **Source, Modulation Setup, ARB, Select Waveform, Segments on Hard Disk**

Remote Command :SOURce:RADio:ARB:LOAD:ALL <string>

Example :SOUR:RAD:ARB:LOAD:ALL "D: varb"

Notes

<string> - specifies the directory on the HDD to load the files into ARB memory from.

When in Sequence Analyzer mode, and Include Source is Yes, an attempt to load all files from a directory to ARB memory is rejected with an error.

When Include Source is No and there is insufficient free ARB memory to load all the waveforms, when the ARB memory is full, the copy ceases, and an error is generated.

If you specify a directory over SCPI, but the directory does not exist, an error is generated.

If the ARB is ON, a user then loads or deletes file to ARB memory, the playing waveform segment may not keep phase continuity during the ARB memory operation. The waveform will be replayed after the ARB operation is finished.

Initial S/W Revision A.05.00

Change Directory...

Allows you to change the currently selected directory on the hard disk. Pressing this key opens a standard windows change directory dialog allowing you to select the new directory of interest.

The current directory is used for manually loading waveform segments into ARB memory for playback, and as a search location for waveform segments that are required to be loaded into ARB memory for playback of a waveform sequence or a list sequence.

Key Path **Source, Modulation Setup, ARB, Select Waveform, Segments on Hard Disk**

Notes No remote command, SCPIfront panel only.

Initial S/W Revision A.05.00

Default Directory...

Allows you to change the default directory. It is used as a search location for waveform segments that are required to be loaded into ARB memory for playback of a waveform sequence, and as a search location for

selecting waveforms using SCPI.

Key Path	Source, Modulation Setup, ARB, Select Waveform, Segments on Hard Disk
Remote Command	:SOURce:RADio:ARB:DEFault:DIRectory <string> :SOURce:RADio:ARB: DEFault:DIRectory?
Example	:SOUR:RAD:ARB:DEF:DIR "D:\ArbFiles" :SOUR:RAD:ARB:DEF:DIR?
State Saved	Persistent, survives a power cycle and a preset but not saved in the instrument state
Initial S/W Revision	A.05.00

Segments in ARB Memory

Allows you access to the sub-menus for managing the files within ARB memory.

Key Path	Source, Modulation Setup, ARB, Select Waveform
Initial S/W Revision	A.05.00

Delete Segment From ARB Mem

Allows you to remove a segment from ARB playback memory.

Key Path	Source, Modulation Setup, ARB, Select Waveform, Segments in ARB Memory
Remote Command	:SOURce:RADio:ARB:DELete <string>
Example	:SOUR:RAD:ARB:DEL "testwaveform.bin"
Notes	<p><string> - specifies the waveform to be deleted from the ARB playback memory.</p> <p>When in Sequence Analyzer mode and Include Source is Yes, an attempt to delete a file from ARB memory is rejected with an error.</p> <p>When Include Source is No and you specify a file that does not exist within ARB memory, an error is generated.</p> <p>It is possible to delete files from within the ARB memory when the ARB is ON. However, if you attempt to delete the file that is currently playing an error is generated.</p> <p>It is possible to delete a file from within the ARB memory when the sequencer state is ON and the file is not being used by the List Sequencer. If you attempt to delete a file which is being used by the list sequencer, an error is generated.</p> <p>When sequencer state is On, even if ARB state is On, the selected waveform will not be played. In this case, if the selected waveform is not used in List Sequence, it can be deleted and the ARB state is turned Off.</p> <p>If the ARB is ON and you load a file to ARB memory or delete a file from ARB memory, the playing waveform segment may not keep phase continuity during the ARB memory operation. The waveform will be replayed after the ARB operation is finished.</p>
Initial S/W Revision	A.05.00

Delete All From ARB Memory

Allows you to remove all segments from ARB playback memory.

Key Path	Source, Modulation Setup, ARB, Select Waveform, Segments in ARB Memory
Remote Command	:SOURce:RADio:ARB:DELeTe:ALL
Example	:SOUR:RAD:ARB:DELeTe:ALL
Notes	<p>When in Sequence Analyzer mode and Include Source is Yes, an attempt to delete all files from ARB memory is rejected with an error.</p> <p>When Include Source is No and you attempt to delete all files from ARB memory when the ARB is currently playing a file, all files except the one playing are deleted and an error is generated.</p> <p>If you attempt to delete all files from ARB memory when there are waveform files used in "List Sequencer" on page 712 and "Sequencer" on page 713 state is ON, all files except the files currently being used in list sequencer are deleted, and an error is generated.</p> <p>If the ARB is ON and you load a file to ARB memory or delete a file from ARB memory, the playing waveform segment may not keep phase continuity during the ARB memory operation. The waveform will be replayed after the ARB operation is finished.</p>
Initial S/W Revision	A.05.00

Query ARB Memory File List (Remote Command Only)

Queries the test set for the list of waveform segments in the ARB memory.

NOTE

This command returns a string for waveform segment names in ARB memory. If you want a string list of waveform segments in the ARB memory, use **"Query ARB Memory Full File List (Remote Command Only)" on page 667**.

Remote Command	:SOURce:RADio:ARB:CATalog?
Example	:SOUR:RAD:ARB:CATalog?
Notes	<p>The return data is in the following format:</p> <p><integer> - memory used</p> <p><integer> - memory free</p> <p><string> ... - comma separated list of waveform segments within ARB memory</p>
Initial S/W Revision	A.05.00

Query ARB Memory Full File List (Remote Command Only)

Queries the test set for the string list of waveform segments in the ARB memory. It returns a string list for waveform segment names in the ARB memory.

Remote Command	:SOURce:RADio:ARB:FCATalog?
Example	:SOUR:RAD:ARB:FCATalog?
Notes	<p>The return data is in the following format:</p> <p><integer> - memory used</p>

	<integer> - memory free <integer> - file count in ARB memory <string>, <string>, ... <string> - comma separated string list of waveform segments within ARB memory Example: SOUR:RAD:ARB:FCAT? EXT returns: 27499,2069653,3,"c2k.wfm","gsm.wfm","wcdma.wfm"
Initial S/W Revision	A.09.00

ARB Setup

Allows access to the ARB setup sub-menus.

Key Path	Source, Modulation Setup, ARB
Initial S/W Revision	A.05.00

Sample Rate

Allows you to set the ARB waveform playback sample rate.

Key Path	Source, Modulation Setup, ARB, ARB Setup
Remote Command	:SOURce:RADio:ARB:SCLock:RATE <freq> :SOURce:RADio:ARB:SCLock:RATE?
Example	:SOUR:RAD:ARB:SCL:RATE 48.00 MHz
Notes	If there is a sample rate specified in the header of the waveform file, changing that sample rate is not recommended, as it may cause problems with burst timing.
Dependencies	When a new waveform is selected for playback the settings contained within the associated waveform header file are applied to the ARB. The sample rate is one of the values stored within the header file. If the newly selected waveform file has an associated header file, the sample rate is updated with the value from the header file. The sample rate will remain unchanged if the newly selected waveform does not have an associated header file.
Preset	125.00 MHz
Min	1.00 kHz
Max	125.00 MHz
Initial S/W Revision	A.05.00

Run-Time Scaling

Allows you to adjust the run-time scaling value. The run-time scaling value is applied in real-time while the waveform is playing.

Key Path	Source, Modulation Setup, ARB, ARB Setup
----------	---

Remote Command	:SOURce:RADio:ARB:RSCaling <real> :SOURce:RADio:ARB:RSCaling?
Example	:SOUR:RAD:ARB:RSC 100.00
Dependencies	When a new waveform is selected for playback the settings contained within the associated waveform header file are applied to the ARB. The run-time scaling is one of the values stored within the header file. If the newly selected waveform file has an associated header file, the run-time scaling is updated with the value from the header file. The run-time scaling will remain unchanged if the newly selected waveform does not have an associated header file.
Preset	70.00 %
Min	1.00 %
Max	100.00 %
Initial S/W Revision	A.05.00

Baseband Freq Offset

Allows you to adjust the value by which the baseband frequency is offset relative to the carrier.

Key Path	Source, Modulation Setup, ARB, ARB Setup
Remote Command	:SOURce:RADio:ARB:BASEband:FREQuency:OFFSet <freq> :SOURce:RADio:ARB:BASEband:FREQuency:OFFSet?
Example	:SOUR:RAD:ARB:BAS:FREQ:OFFS 0.00 Hz
Dependencies	When a new waveform is selected for playback the settings contained within the associated waveform header file are applied to the ARB. The baseband frequency offset is one of the values stored within the header file. If the newly selected waveform file has an associated header file, the baseband frequency offset is updated with the value from the header file. The baseband frequency offset will remain unchanged if the newly selected waveform does not have an associated header file.
Preset	0.00 Hz
Min	-50.00 MHz
Max	50.00 MHz
Initial S/W Revision	A.05.00

Edit RMS

Allows you to edit or calculate current RMS of selected waveform.

Key Path	Source, Modulation Setup, ARB, ARB Setup
Initial S/W Revision	A.14.50

Current RMS

Allows you to directly specify current RMS value used to playback currently selected waveform. Please note incorrect RMS value may cause inaccurate power output in E6640A that is sensitive to RMS value.

This setting is also updated by RMS in waveform header or updated when invoking RMS calculation operation.

This setting can be saved to the header of currently selected waveform by invoking ["Save Setup To Header" on page 707](#) "Save Setup To Header".

Key Path	Source, Modulation Setup, ARB, ARB Setup, Edit RMS
Remote Command	:SOURce:RADio:ARB:RMS <float> :SOURce:RADio:ARB:RMS?
Example	:SOUR:RAD:ARB:HEAD:RMS 0.7 :SOUR:RAD:ARB:HEAD:RMS?
Notes	Valid range is 0 to 1.414, values outside the range will be clipped to the closest boundary. Note this value does not affect "List Sequencer" on page 712 Source List Sequencer that always uses RMS value resides in each ARB header. If want this value to take effect in list sequencer, use "Save Setup To Header" on page 707 "Save Setup to Header" to save current RMS value to header first, then play the ARB in source list sequencer.
Dependencies	When a new waveform is selected for playback, this setting is updated by the RMS value defined in associated waveform header file. If selected waveform has no associated header file or header file does not specify RMS value, then instrument will try to calculate out one automatically. Calculating RMS can also update this setting.
Preset	0
Range	0 ~ 1.414
Initial S/W Revision	A.14.50

RMS Calculation Mode

Allows you to specify the mode to calculate the current RMS.

Key Path	Source, Modulation Setup, ARB, ARB Setup, Edit RMS
Remote Command	:SOURce:RADio:ARB:RMS:CALCulation:MODE AUTO M1 M2 M3 M4 :SOURce:RADio:ARB:RMS:CALCulation:MODE?
Example	:SOUR:RAD:ARB:RMS:CALC:MODE AUTO
Notes	If no waveform is selected, or selected waveform is waveform sequence, the key will grey out.
Preset	AUTO
Range	AUTO M1 M2 M3 M4
Initial S/W Revision	A.14.50

Auto

RMS will be calculated based on the whole sample range of current selected waveform.

Key Path	Source, Modulation Setup, ARB, ARB Setup, Edit RMS, Calculate RMS, RMS Calculation Mode
Example	:SOUR:RAD:ARB:RMS:CALC:MODE AUTO
Initial S/W Revision	A.14.50

Marker 1

Selects marker 1 to designate sample range used for RMS calculation.

Key Path	Source, Modulation Setup, ARB, ARB Setup, Edit RMS, Calculate RMS, RMS Calculation Mode , Marker
Example	:SOUR:RAD:ARB:RMS:CALC:MODE M1
Initial S/W Revision	A.14.50

Marker 2

Selects marker 2 to designate sample range used for RMS calculation.

Key Path	Source, Modulation Setup, ARB, ARB Setup, Edit RMS, Calculate RMS, RMS Calculation Mode , Marker
Example	:SOUR:RAD:ARB:RMS:CALC:MODE M2
Initial S/W Revision	A.14.50

Marker 3

Selects marker 3 to designate sample range used for RMS calculation.

Key Path	Source, Modulation Setup, ARB, ARB Setup, Edit RMS, Calculate RMS, RMS Calculation Mode , Marker
Example	:SOUR:RAD:ARB:RMS:CALC:MODE M3
Initial S/W Revision	A.14.50

Marker 4

Selects marker 4 to designate sample range used for RMS calculation.

Key Path	Source, Modulation Setup, ARB, ARB Setup, Edit RMS, Calculate RMS, RMS Calculation Mode , Marker
Example	:SOUR:RAD:ARB:RMS:CALC:MODE M4
Initial S/W Revision	A.14.50

Calculate RMS

Allows you to calculate current RMS based on mode selected. This will update ["Current RMS" on page 670](#) Current RMS setting.

Key Path	Source, Modulation Setup, ARB, ARB Setup, Edit RMS, Calculate RMS
Remote Command	:SOURce:RADio:ARB:RMS:CALCulate
Example	:SOUR:RAD:ARB:RMS:CALC
Notes	<p>If no waveform is selected, invoking this operation will get error “-221 Setting conflict; No waveform is selected for RMS operation”.</p> <p>If no waveform is selected, or selected waveform is waveform sequence, the key will grey out.</p> <p>If selected waveform does not contain marker data, but "RMS Calculation Mode" on page 670 “RMS Calculation Mode” is set to marker, under this circumstance, invoking calculation operation will get error “-221 Setting conflict; There is no marker for currently selected waveform, auto RMS calculation mode is used instead”, and "RMS Calculation Mode" on page 670 “RMS Calculation Mode” will be coupled to “Auto” mode automatically.</p> <p>RMS calculation does not suit for waveform sequence. If selected waveform is waveform sequence file, invoking this operation will get error “-221 Setting conflict; RMS calculation does not apply to waveform sequence”. But users can still edit current RMS as play parameter, and can save current RMS to waveform sequence header for later use.</p>
Initial S/W Revision	A.14.50

Use Header RMS

Allows you to quickly set RMS in ARB header to ["Current RMS" on page 670](#) Current RMS setting.

Key Path	Source, Modulation Setup, ARB, ARB Setup, Edit RMS,
Notes	<p>No remote command, front panel only.</p> <p>If no waveform is selected, the key will grey out.</p> <p>If no waveform is selected, invoking this operation will get error “-221 Setting conflict; No waveform is selected for RMS operation”.</p>
Initial S/W Revision	A.14.50

Real-Time AWGN Setup

The source allows you to apply additive white Gaussian noise (AWGN) to a carrier in real time while the modulating waveform plays in the dual ARB player. Pressing this key allows access to the real time AWGN sub-menus and changes the central display area to show the AWGN Setup view.

This feature is controlled by E6650A-AW1 option

Key Path	Source, Modulation Setup, ARB, ARB Setup
Notes	This menu only appears and related SCPIs are only available when E6650A-AW1 option presents.
Initial S/W Revision	A.16.00

Real-Time AWGN

Allows you to enable or disable adding real-time AWGN to the carrier modulated by the waveform currently being played by the dual ARB.

Key Path	Source, Modulation Setup, ARB, ARB Setup, Real-Time AWGN Setup
Remote Command	:SOURce:RADio:ARB:NOISe[:STATe] ON OFF 1 0 :SOURce:RADio:ARB:NOISe[:STATe]?
Example	:SOUR:RAD:ARB:NOIS OFF
Dependencies	When a new waveform is selected for playback the settings contained within the associated waveform header file are applied to the ARB. The AWGN state is one of the values stored within the header file. If the newly selected waveform file has an associated header file, the AWGN state is updated with the value from the header file. The AWGN state will remain unchanged if the newly selected waveform does not have an associated header file.
Couplings	If this setting is On and "ARB" on page 662 ARB State is On, "RF Power" on page 627 RF Power will be adjusted to the value to maintain the AWGN power relationship defined by "Power Control Mode" on page 674 Power Control Mode and other noise settings
Preset	Off
Range	On Off
Initial S/W Revision	A.16.00

Carrier To Noise Ratio

Allows you to specify the carrier to noise ratio (C/N) in dB. The carrier power is defined as the total modulated signal power without noise power added. The noise power is applied over the specified bandwidth of the carrier signal.

Key Path	Source, Modulation Setup, ARB, ARB Setup, Real-Time AWGN Setup
Remote Command	:SOURce:RADio:ARB:NOISe:CN <ampl> :SOURce:RADio:ARB:NOISe:CN?
Example	:SOUR:RAD:ARB:NOIS:CN 0.00 dB
Dependencies	When a new waveform is selected for playback the settings contained within the associated waveform header file are applied to the ARB. The AWGN C/N ratio is one of the values stored within the header file. If the newly selected waveform file has an associated header file, the AWGN C/N ratio is updated with the value from the header file. The AWGN C/N ratio will remain unchanged if the newly selected waveform does not have an associated header file.
Preset	0.00 dB
Min	-100.00 dB
Max	100.00 dB
Initial S/W Revision	A.16.00

Carrier Bandwidth

Allows you to specify the bandwidth over which the AWGN is applied. The carrier RMS power and the noise power are integrated over the selected carrier bandwidth for the purpose of calculating carrier to noise ratio (C/N).

Key Path	Source, Modulation Setup, ARB, ARB Setup, Real-Time AWGN Setup
Remote Command	:SOURCE:RADio:ARB:NOISe:CBWidth <freq> :SOURCE:RADio:ARB:NOISe:CBWidth?
Example	:SOUR:RAD:ARB:NOIS:CBW 1.00 Hz
Dependencies	When a new waveform is selected for playback the settings contained within the associated waveform header file are applied to the ARB. The AWGN carrier bandwidth is one of the values stored within the header file. If the newly selected waveform file has an associated header file, the AWGN carrier bandwidth is updated with the value from the header file. The AWGN carrier bandwidth will remain unchanged if the newly selected waveform does not have an associated header file.
Min	1.00 Hz
Max	200.00 MHz
Initial S/W Revision	A.16.00

Noise Bandwidth

Allows you to specify the flat noise bandwidth of the real-time noise for an ARB waveform.

Key Path	Source, Modulation Setup, ARB, ARB Setup, Real-Time AWGN Setup
Remote Command	:SOURCE:RADio:ARB:NOISe:BANDwidth <freq> :SOURCE:RADio:ARB:NOISe:BANDwidth?
Example	:SOUR:RAD:ARB:NOIS:BAND 1.00 Hz
Notes	Generally, flat noise bandwidth should be set slightly wider than the carrier bandwidth (typically 1.6 times wider)
Notes	Max Noise Bandwidth equals $0.8 * \text{Maximum ARB Sample Rate}$ reported in HW capability
Dependencies	When a new waveform is selected for playback the settings contained within the associated waveform header file are applied to the ARB. The AWGN carrier bandwidth is one of the values stored within the header file. If the newly selected waveform file has an associated header file, the AWGN carrier bandwidth is updated with the value from the header file. The AWGN carrier bandwidth will remain unchanged if the newly selected waveform does not have an associated header file.
Preset	1.00 Hz
Min	1.00 Hz
Max	160.00 MHz
Initial S/W Revision	A.16.00

Power Control Mode

This setting offers four ways to control the RF output power when adding AWGN to a signal.

Key Path	Source, Modulation Setup, ARB, ARB Setup, Real-Time AWGN Setup
Remote Command	:SOURce:RADio:ARB:NOISe:POWer:CONTRol[:MODE] TOTal CARRier NOISe NCHannel :SOURce:RADio:ARB:NOISe: POWer:CONTRol[:MODE]?
Example	:SOUR:RAD:ARB:NOIS:POW:CONT NCHannel :SOUR:RAD:ARB:NOIS:POW:CONT?
Preset	TOTal
Range	Total Power Carrier Power Total Noise Power Noise Power in Channel
Initial S/W Revision	A.16.00

Total

Set the power control mode as total power.

Key Path	Source, Modulation Setup, ARB, ARB Setup, Real-Time AWGN Setup, Power Control Mode
Example	:SOUR:RAD:ARB:NOIS:POW:CONT TOTal
Couplings	Set to this value will make Carrier Power Carrier Power, Total Noise Power Total Noise Power, and Channel Noise Power Channel Noise Power buttons invisible on menu. Selecting Total as the power control mode makes the total power and C/N independent variables while making the carrier power and total noise power dependent variables. The dependent variables carrier power and total noise power are set by the total power, C/N, and the rest of the Noise settings. The carrier power and total noise power change as any noise parameter is adjusted to keep the total power and the C/N at their last specified values.
Initial S/W Revision	A.16.00

Carrier

Set the power control mode as carrier power.

Key Path	Source, Modulation Setup, ARB, ARB Setup, Real-Time AWGN Setup, Power Control Mode
Example	:SOUR:RAD:ARB:NOIS:POW:CONT CARRier
Couplings	Set to this value will make Carrier Power Carrier Power button visible, while Total Noise Power Total Noise Power and Channel Noise Power Channel Noise Power buttons invisible from menu. Selecting Carrier as the power control mode makes the carrier power and C/N independent variables while making the total power and total noise power dependent variables. The dependent variables total power and total noise power are set by the carrier power, C/N, and the rest of the Noise settings. The total power and total noise power change as any noise parameter is adjusted to keep the carrier power and the C/N at their last specified values.
Initial S/W Revision	A.16.00

Total Noise

Set the power control mode as total noise power.

Key Path	Source, Modulation Setup, ARB, ARB Setup, Real-Time AWGN Setup, Power Control Mode
Example	:SOUR:RAD:ARB:NOIS:POW:CONT NOISe
Couplings	Set to this value will make Total Noise Power Total Noise Power button visible, while Carrier Power Carrier Power and Channel Noise Power Channel Noise Power buttons invisible from menu. Selecting Total Noise as the power control mode makes the total noise power and C/N independent variables while making the total power and carrier power dependent variables. The dependent variables total power and carrier power are set by the total noise power, C/N, and the rest of the Noise settings. The total power and carrier power change as any noise parameter is adjusted to keep the total noise power and the C/N at their last specified values.
Initial S/W Revision	A.16.00

Channel Noise

Set the power control mode as channel noise power.

Key Path	Source, Modulation Setup, ARB, ARB Setup, Real-Time AWGN Setup, Power Control Mode
Example	:SOUR:RAD:ARB:NOIS:POW:CONT NChannel
Couplings	Set to this value will make Channel Noise Power Channel Noise Power button visible, while Total Noise Power Total Noise Power and Carrier Power Carrier Power buttons invisible from menu. Selecting Channel Noise as the power control mode makes the noise power in channel and C/N independent variables while making the carrier power and total noise power dependent variables. The dependent variables carrier power and total noise power are set by the channel noise power, C/N, and the rest of the Noise settings. The carrier power and total noise power change as any noise parameter is adjusted to keep the channel noise power and the C/N at their last specified values.
Initial S/W Revision	A.16.00

Trigger Type

Allows access to the trigger type sub-menus. The setting for trigger type determines the behavior of the waveform when it plays.

Key Path	Source, Modulation Setup, ARB
Remote Command	:SOURce:RADio:ARB:TRIGger:TYPE CONTInuous SINGle SADVance :SOURce:RADio:ARB:TRIGger:TYPE?
Example	:SOUR:RAD:ARB:TRIG:TYPE CONT :SOUR:RAD:ARB:TRIG:TYPE?
Notes	Gated trigger type will be implemented at a later release
Preset	CONTInuous
Range	Continuous Single Seg Adv
Initial S/W Revision	A.05.00

Continuous

Sets the active trigger type to Continuous. If Continuous is already selected as the active trigger type, pressing this key allows access to the continuous trigger type setup menu. In Continuous trigger mode, the waveform repeats continuously.

Key Path	Source, Modulation Setup, ARB, Trigger Type
Remote Command	:SOURce:RADio:ARB:TRIGger:TYPE:CONTInuous[:TYPE] FREE TRIGger RESet :SOURce:RADio:ARB:TRIGger:TYPE:CONTInuous[:TYPE]?
Example	:SOUR:RAD:ARB:TRIG:TYPE:CONT FREE
Preset	FREE
Range	Free Run Trigger + Run Reset + Run
Initial S/W Revision	A.05.00

Free Run

Selects Free Run as the trigger response for the continuous trigger type. Free Run sets the waveform generator to play a waveform sequence or segment continuously, without waiting for a trigger. In this mode, the waveform generator does not respond to triggers.

Key Path	Source, Modulation Setup, ARB, Trigger Type, Continuous
Example	:SOUR:RAD:ARB:TRIG:TYPE:CONT FREE
Initial S/W Revision	A.05.00

Trigger + Run

Sets Trigger and Run as the trigger response for the continuous trigger type. Trigger and Run sets the waveform generator to play a waveform sequence or segment continuously when the first trigger is received, and to ignore any subsequent triggers.

Key Path	Source, Modulation Setup, ARB, Trigger Type, Continuous
Example	:SOUR:RAD:ARB:TRIG:TYPE:CONT TRIG
Initial S/W Revision	A.05.00

Reset + Run

Sets Reset and Run as the trigger response for the continuous trigger type. Reset and Run sets the waveform generator to play a waveform sequence or segment continuously when the first trigger is received. Subsequent triggers reset the waveform sequence or segment to the start, and then play it continuously.

Key Path	Source, Modulation Setup, ARB, Trigger Type, Continuous
Example	:SOUR:RAD:ARB:TRIG:TYPE:CONT RES
Initial S/W Revision	A.05.00

Single

Sets the active trigger type to Single. If Single is already selected as the active trigger type, pressing this key allows access to the single trigger type setup menu. In Single trigger mode, the waveform plays once.

Key Path	Source, Modulation Setup, ARB, Trigger Type
Remote Command	:SOURce:RADio:ARB:RETRigger ON OFF IMMediate :SOURce:RADio:ARB:RETRigger?
Example	:SOUR:RAD:ARB:RETR OFF
Notes	ON: Buffered Trigger OFF: No Retrigger Immediate: Restart on Trigger This is defined as an enumerated SCPI command, with ON OFF being considered as enumerated types rather than Boolean. This means the query will return OFF instead of 0, and ON instead of 1.
Preset	ON
Range	No Retrigger Buffered Trigger Restart on Trigger
Initial S/W Revision	A.05.00

No Retrigger

Selects No Retrigger as the trigger response for single trigger type. No Retrigger sets the waveform generator to play a waveform sequence or segment once when a trigger is received. Any triggers then received during playback are ignored.

Key Path	Source, Modulation Setup, ARB, Trigger Type, Single
Example	:SOUR:RAD:ARB:RETR OFF
Initial S/W Revision	A.05.00

Buffered Trigger

Selects Buffered Trigger as the trigger response for single trigger type. Buffered Trigger sets the waveform generator to play a waveform sequence or segment once when a trigger is received. If a trigger is received during playback, the waveform generator plays the sequence or segment to the end, then plays the sequence or segment once more.

Key Path	Source, Modulation Setup, ARB, Trigger Type, Single
Example	:SOUR:RAD:ARB:RETR ON
Initial S/W Revision	A.05.00

Restart on Trigger

Selects Restart on Trigger as the trigger response for single trigger type. Restart on Trigger sets the waveform generator to play a waveform sequence or segment once when a trigger is received. If a trigger is received during playback, the waveform generator resets and plays the sequence or segment from the start.

Key Path	Source, Modulation Setup, ARB, Trigger Type, Single
Example	:SOUR:RAD:ARB:RETR IMM
Initial S/W Revision	A.05.00

Segment Advance

Sets the active trigger type to Segment Advance. If Segment Advance is already selected as the active trigger type, pressing this key allows access to the segment advance trigger type setup menu.

Segment Advance triggering allows you to control the playback of waveform segments within a waveform sequence. When a trigger is received the ARB advances to the next waveform segment within the waveform sequence. This type of triggering ignores the repetition count for the waveform segment within the waveform sequence. For example, if a waveform segment has a repetition count of 10 and you select single segment advance triggering mode, the waveform segment will only play once.

Segment Advance triggering can also be used for waveform segments only. In this situation the same waveform segment is played again when a trigger is received.

Key Path	Source, Modulation Setup, ARB, Trigger Type
Remote Command	:SOURce:RADio:ARB:TRIGger:TYPE:SADVance[:TYPE] SINGLE CONTInuous :SOURce:RADio:ARB:TRIGger:TYPE:SADVance[:TYPE]?
Example	:SOUR:RAD:ARB:TRIG:TYPE:SADV SING
Preset	CONTInuous
Range	Single Continuous
Initial S/W Revision	A.05.00

Single

Selects Single as the trigger response for Segment Advance trigger type. With single selected, once a trigger is received a segment is played once. If a trigger is received during playback of a segment, the segment plays to completion and the next segment is played once.

Key Path	Source, Modulation Setup, ARB, Trigger Type, Segment Advance
Example	:SOUR:RAD:ARB:TRIG:TYPE:SADV SING
Initial S/W Revision	A.05.00

Continuous

Selects Continuous as the trigger response for Segment Advance trigger type. With continuous selected, once a trigger is received a segment is played continuously. When subsequent triggers are received, the currently playing segment plays to completion and then the next segment is played continuously.

Key Path	Source, Modulation Setup, ARB, Trigger Type, Segment Advance
Example	:SOUR:RAD:ARB:TRIG:TYPE:SADV CONT
Initial S/W Revision	A.05.00

Trigger Source

The trigger source setting determines how the source receives the trigger that starts the waveform playing. Therefore, this key is grayed out if the trigger type is free run, since free run triggers immediately with no trigger source required.

Key Path	Source, Modulation Setup, ARB
Remote Command	:SOURce:RADio:ARB:TRIGger[:SOURce] KEY BUS EXTernal2 :SOURce:RADio:ARB:TRIGger[:SOURce]?
Example	:SOUR:RAD:ARB:TRIGger KEY
Dependencies	This key is grayed out if the current trigger type is Continuous, Free Run.
Preset	EXTernal2
Range	Trigger Key Bus External 2
Initial S/W Revision	A.05.00

Trigger Key

Sets the current trigger source to the front panel Trigger key. When Trigger Key is selected, the waveform is triggered when you press the front panel Trigger key.

Key Path	Source, Modulation Setup, ARB, Trigger Source
Example	:SOUR:RAD:ARB:TRIGger KEY
Initial S/W Revision	A.05.00

Bus

Sets the current trigger source to Bus. Selecting Bus trigger source enables triggering over GPIB, LAN, or USB using the :SOURce:RADio:ARB:TRIGger:INITiate command.

Key Path	Source, Modulation Setup, ARB, Trigger Source
Example	:SOUR:RAD:ARB:TRIGger BUS
Initial S/W Revision	A.05.00

External 2

Sets the current trigger source to External 2. Selecting External 2 enables triggering a waveform by an externally applied signal.

Key Path	Source, Modulation Setup, ARB, Trigger Source
Example	:SOUR:RAD:ARB:TRIGger EXT2
Notes	Note: When on E6640A, trigger 2 is a bi-directional trigger port. So when trigger 2 has been configured as OUTPUT type, choosing External 2 as the input trigger for the current step will generate error.
Initial S/W Revision	A.05.00

Trigger Initiate

Used to initiate an immediate trigger event if the trigger source is set to Trigger Key.

Key Path	Source, Modulation Setup, ARB
Notes	No remote command, SCPI front panel only.
Initial S/W Revision	A.05.00

Waveform Sequences

Allows access to the waveform sequence sub-menus. Pressing this key changes the central view area to display the Waveform Sequence List view.

Key Path	Source, Modulation Setup, ARB
Notes	No remote command, SCPI front panel only.
Initial S/W Revision	A.05.00

Build New Sequence

Allows access to the sub-menus for creating a new waveform sequence. Pressing this key changes the central view area to display the Waveform Sequence Creation and Editing view.

Key Path	Source, Modulation Setup, ARB, Waveform Sequences
Notes	No remote command, SCPI front panel only.
Initial S/W Revision	A.05.00

Current Segment

Specifies the selected sequence segment that will be affected by the menu functions.

Key Path	Source, Modulation Setup , ARB, Waveform Sequences, Build New Sequence
Notes	No remote command, SCPI front panel only. This key is grayed out and unavailable if the sequence is currently empty.
Initial S/W Revision	A.05.00

Insert New Waveform

Allows you access to the sub-menu for inserting a new waveform segment or sequence. Pressing this key also changes the central display to show the Waveform File Selection View.

Key Path	Source, Modulation Setup, ARB, Waveform Sequences, Build New Sequence
Notes	No remote command, SCPI front panel only. Waveform segment name string length upper limit is 128 chars. Please do NOT insert waveform which name string exceeds 128 chars.
Initial S/W Revision	A.05.00

Insert Waveform

Inserts the currently highlighted waveform to the end of the waveform sequence. Pressing this key also returns you to the menus for creating or editing a sequence, and returns the central view to the sequence creation view.

Key Path	Source, Modulation Setup, ARB, Waveform Sequences, Build New Sequence, Insert New Waveform
Notes	No remote command, SCPI front panel only. Waveform segment name string length upper limit is 128 chars. Please do NOT insert waveform which name string exceeds 128 chars.
Initial S/W Revision	A.05.00

Segments on Hard Disk

Allows you access to the sub-menus for loading waveform segments from the hard disk into ARB memory. The default directory is: D: varb.

Pressing this key changes the current view to the Waveform Management View.

Key Path	Source, Modulation Setup, ARB, Select Waveform
Initial S/W Revision	A.05.00

Load Segment To ARB Memory

Allows you to load the selected file into ARB memory. On the front panel you select the file for loading to the ARB memory by highlighting the desired file in the list. Using the SCPI command, you specify the file name on the HDD.

“NVWFM” (none-volatile storage) MSUS (Mass Storage Unit Specifier) is supported in the memory subsystem because the ARB memory cannot be accessed directly. Therefore, files must be downloaded to the instrument hard disk and then loaded into the ARB memory. “NVWFM” MSUS will be mapped to the default directory D: VARB. The SCPI command supports using either “NVWFM” MSUS or specifying a full path. For more information, see [Memory Subsystem \(Remote Command Only\)](#).

If a file of the same name already exists within ARB memory, it is overwritten. If you wish to load two segments of the same name, you must rename one of the segments before loading it into ARB memory. To rename a segment, you can either use Windows File Explorer, or the :MMEMory:COPY command.

Key Path	Source, Modulation Setup, ARB, Select Waveform, Segments on Hard Disk
Remote Command	:SOURce:RADio:ARB:LOAD <string>
Example	:SOUR:RAD:ARB:LOAD "D: VARB\testwaveform.bin" or :SOUR:RAD:ARB:LOAD "NVWFM:testwaveform.bin"
Notes	<p>Because loading the file involves a delay of unpredictable length, this command should be followed by the query *OPC?, which holds off subsequent commands until the loading operating is complete.</p> <p><string> – specifies the path name of the file to load from the HDD into ARB memory. It could be a <full path + filename>, or <“NVWFM” MSUS + colon + filename>.</p> <p>When in Sequence Analyzer mode, and Include Source is Yes, an attempt to load a file to ARB memory will be rejected with an error.</p> <p>When Include Source is No and if there is insufficient free ARB memory to load the selected waveform, an error is generated. .</p> <p>If you specify a file over SCPI, but the file is not at the specified location, an error is generated.</p> <p>If you try to load a waveform file but the file contains less than 500 IQ samples, an error is generated.</p> <p>If you try to load a Signal Studio waveform “*.wfm” which contains invalid waveform header, an error is generated.</p> <p>If the ARB is ON when you load a file to ARB memory or delete a file from ARB memory, the playing waveform segment may not keep phase continuity during the ARB memory operation. The waveform will be replayed after the ARB operation is finished.</p> <p>ARB can be loaded into ARB memory even required licenses do not present on the instrument. In this case, a GUI only warning message –800, “Operation complete; Loaded <filename> successfully, but no license <required licenses> installed”. User can install required licenses according to <required licenses> string to license it, or multi-pack license it.</p>
Initial S/W Revision	A.05.00

Load All To ARB Memory

Allows you to load all the segment files within the currently selected directory into ARB memory. If a file of the same name already exists within ARB memory, it is overwritten. If you wish to load two segments of the

same name, you must rename one of the segments before loading it into ARB memory. To rename a segment, you can either use Windows File Explorer, or the :MEMory:COpy command.

Key Path	Source, Modulation Setup, ARB, Select Waveform, Segments on Hard Disk
Remote Command	:SOURce:RADio:ARB:LOAD:ALL <string>
Example	:SOUR:RAD:ARB:LOAD:ALL "D: varb"
Notes	<p><string> - specifies the directory on the HDD to load the files into ARB memory from.</p> <p>When in Sequence Analyzer mode, and Include Source is Yes, an attempt to load all files from a directory to ARB memory is rejected with an error.</p> <p>When Include Source is No and there is insufficient free ARB memory to load all the waveforms, when the ARB memory is full, the copy ceases, and an error is generated.</p> <p>If you specify a directory over SCPI, but the directory does not exist, an error is generated.</p> <p>If the ARB is ON, a user then loads or deletes file to ARB memory, the playing waveform segment may not keep phase continuity during the ARB memory operation. The waveform will be replayed after the ARB operation is finished.</p>
Initial S/W Revision	A.05.00

Change Directory...

Allows you to change the currently selected directory on the hard disk. Pressing this key opens a standard windows change directory dialog allowing you to select the new directory of interest.

The current directory is used for manually loading waveform segments into ARB memory for playback, and as a search location for waveform segments that are required to be loaded into ARB memory for playback of a waveform sequence or a list sequence.

Key Path	Source, Modulation Setup, ARB, Select Waveform, Segments on Hard Disk
Notes	No remote command, SCPIfront panel only.
Initial S/W Revision	A.05.00

Default Directory...

Allows you to change the default directory. It is used as a search location for waveform segments that are required to be loaded into ARB memory for playback of a waveform sequence, and as a search location for selecting waveforms using SCPI.

Key Path	Source, Modulation Setup, ARB, Select Waveform, Segments on Hard Disk
Remote Command	:SOURce:RADio:ARB:DEFault:DIRectory <string> :SOURce:RADio:ARB: DEFault:DIRectory?
Example	:SOUR:RAD:ARB:DEF:DIR "D:\ArbFiles" :SOUR:RAD:ARB:DEF:DIR?
State Saved	Persistent, survives a power cycle and a preset but not saved in the instrument state
Initial S/W Revision	A.05.00

Segments in ARB Memory

Allows you access to the sub-menus for managing the files within ARB memory.

Key Path	Source, Modulation Setup, ARB, Select Waveform
Initial S/W Revision	A.05.00

Delete Segment From ARB Mem

Allows you to remove a segment from ARB playback memory.

Key Path	Source, Modulation Setup, ARB, Select Waveform, Segments in ARB Memory
Remote Command	:SOURce:RADio:ARB:DELeTe <string>
Example	:SOUR:RAD:ARB:DEL "testwaveform.bin"
Notes	<p><string> - specifies the waveform to be deleted from the ARB playback memory.</p> <p>When in Sequence Analyzer mode and Include Source is Yes, an attempt to delete a file from ARB memory is rejected with an error.</p> <p>When Include Source is No and you specify a file that does not exist within ARB memory, an error is generated.</p> <p>It is possible to delete files from within the ARB memory when the ARB is ON. However, if you attempt to delete the file that is currently playing an error is generated.</p> <p>It is possible to delete a file from within the ARB memory when the sequencer state is ON and the file is not being used by the List Sequencer. If you attempt to delete a file which is being used by the list sequencer, an error is generated.</p> <p>When sequencer state is On, even if ARB state is On, the selected waveform will not be played. In this case, if the selected waveform is not used in List Sequence, it can be deleted and the ARB state is turned Off.</p> <p>If the ARB is ON and you load a file to ARB memory or delete a file from ARB memory, the playing waveform segment may not keep phase continuity during the ARB memory operation. The waveform will be replayed after the ARB operation is finished.</p>
Initial S/W Revision	A.05.00

Delete All From ARB Memory

Allows you to remove all segments from ARB playback memory.

Key Path	Source, Modulation Setup, ARB, Select Waveform, Segments in ARB Memory
Remote Command	:SOURce:RADio:ARB:DELeTe:ALL
Example	:SOUR:RAD:ARB:DELeTe:ALL
Notes	<p>When in Sequence Analyzer mode and Include Source is Yes, an attempt to delete all files from ARB memory is rejected with an error.</p> <p>When Include Source is No and you attempt to delete all files from ARB memory when the ARB is currently playing a file, all files except the one playing are deleted and an error is generated.</p> <p>If you attempt to delete all files from ARB memory when there are waveform files used in "List</p>

Sequencer" on page 712 and **"Sequencer" on page 713** state is ON, all files except the files currently being used in list sequencer are deleted, and an error is generated.

If the ARB is ON and you load a file to ARB memory or delete a file from ARB memory, the playing waveform segment may not keep phase continuity during the ARB memory operation. The waveform will be replayed after the ARB operation is finished.

Initial S/W Revision	A.05.00
----------------------	---------

Segments on Hard Disk

This key functions the same as **"Segments on Hard Disk" on page 738**.

Key Path	Source, Modulation Setup, ARB, Waveform Sequences, Build New Sequence, Insert New Waveform
----------	---

Initial S/W Revision	Prior to A.09.00
----------------------	------------------

Load Segment To ARB Memory

This key functions the same as **"Load Segment To ARB Memory" on page 738**.

Key Path	Source, Modulation Setup, ARB, Waveform Sequences, Build New Sequence, Insert New Waveform, Segment on Hard Drive
----------	--

Initial S/W Revision	Prior to A.09.00
----------------------	------------------

Load All To ARB Memory

This key functions the same as **"Load All To ARB Memory" on page 739**.

Key Path	Source, Modulation Setup, ARB, Waveform Sequences, Build New Sequence, Insert New Waveform, Segment on Hard Drive
----------	--

Initial S/W Revision	Prior to A.09.00
----------------------	------------------

Change Directory ...

This key functions the same as **"Change Directory..." on page 740**.

Key Path	Source, Modulation Setup, ARB, Waveform Sequences, Build New Sequence, Insert New Waveform, Segment on Hard Drive
----------	--

Initial S/W Revision	Prior to A.09.00
----------------------	------------------

Default Directory ...

This key functions the same as **"Default Directory..." on page 740**

Key Path	Source, Modulation Setup, ARB, Waveform Sequences, Build New Sequence, Insert New Waveform, Segment on Hard Drive
Initial S/W Revision	Prior to A.09.00

Segments in ARB Memory

This key functions the same as ["Segments in ARB Memory" on page 740.](#)

Key Path	Source, Modulation Setup, ARB, Waveform Sequences, Build New Sequence, Insert New Waveform
Initial S/W Revision	Prior to A.09.00

Delete Segment From ARB Memory

This key functions the same as ["Delete Segment From ARB Mem" on page 741.](#)

Key Path	Source, Modulation Setup, ARB, Waveform Sequences, Build New Sequence, Insert New Waveform, Segment in ARB Memory
Initial S/W Revision	Prior to A.09.00

Delete All From ARB Memory

This key functions the same as ["Delete All From ARB Memory" on page 741.](#)

Key Path	Source, Modulation Setup, ARB, Waveform Sequences, Build New Sequence, Insert New Waveform, Segment in ARB Memory
Initial S/W Revision	Prior to A.09.00

Query ARB Memory File List (Remote Command Only)

This command functions the same as ["Query ARB Memory File List \(Remote Command Only\)" on page 667.](#)

Initial S/W Revision	Prior to A.09.00
----------------------	------------------

Edit Selected Waveform

Allows access to the sub-menus for editing the details of the currently selected waveform segment.

Key Path	Source, Modulation Setup, ARB, Waveform Sequences, Build New Sequence
Notes	No remote command, front panel only.
Initial S/W Revision	A.05.00

Repetitions

Allows you to specify the number of times the currently selected waveform is played within the sequence.

Key Path	Source, Modulation Setup, ARB, Waveform Sequences, Build New Sequence, Edit Selected Waveform
Notes	No remote command, SCPI front panel only.
Preset	1
Min	1
Max	65535
Initial S/W Revision	A.05.00

Marker 1

Allows you to enable or disable marker 1 for the currently selected waveform. For a waveform sequence, you can enable and disable markers on a per-segment basis, allowing you to output markers from some waveform segments within the sequence, but not for others.

Key Path	Source, Modulation Setup, ARB, Waveform Sequences, Build New Sequence, Edit Selected Waveform
Notes	No remote command, front panel only.
Preset	Enabled
Range	Enabled Disabled
Initial S/W Revision	A.05.00

Marker 2

Allows you to enable or disable marker 2 for the currently selected waveform. For a waveform sequence, you can enable and disable markers on a per-segment basis, allowing you to output markers from some waveform segments within the sequence, but not for others.

Key Path	Source, Modulation Setup, ARB, Waveform Sequences, Build New Sequence, Edit Selected Waveform
Notes	No remote command, front panel only.
Preset	Enabled
Range	Enabled Disabled
Initial S/W Revision	A.05.00

Marker 3

Allows you to enable or disable marker 3 for the currently selected waveform. For a waveform sequence, you can enable and disable markers on a per-segment basis, allowing you to output markers from some waveform segments within the sequence, but not for others.

Key Path	Source, Modulation Setup, ARB, Waveform Sequences, Build New Sequence, Edit Selected Waveform
Notes	No remote command, front panel only.
Preset	Enabled
Range	Enabled Disabled
Initial S/W Revision	A.05.00

Marker 4

Allows you to enable or disable marker 4 for the currently selected waveform. For a waveform sequence, you can enable and disable markers on a per-segment basis, allowing you to output markers from some waveform segments within the sequence, but not for others.

Key Path	Source, Modulation Setup, ARB, Waveform Sequences, Build New Sequence, Edit Selected Waveform
Notes	No remote command, front panel only.
Preset	Enabled
Range	Enabled Disabled
Initial S/W Revision	A.05.00

Delete Segment

Allows you to delete the selected segment from the waveform sequence.

Key Path	Source, Modulation Setup, ARB, Waveform Sequences, Build New Sequence
Notes	No remote command, front panel only.
Initial S/W Revision	A.05.00

Save Sequence...

Pressing this key displays the “Save As” dialog. The sequence name is passed to the save as dialog to use as the filename for saving, and the directory the save as dialog will open into is the default waveform directory.

Key Path	Source, Modulation Setup, ARB, Waveform Sequences, Build New Sequence
Initial S/W Revision	A.05.00

Build New Sequence (Remote Command Only)

This command is the SCPI equivalent of the waveform sequence creation features described in ["Build New Sequence" on page 681](#).

This command writes a waveform sequence file to the hard disk. You must specify the waveform sequence file path and filename which will be saved on the hard disk, and the waveform segment file path and name which will be nested into the waveform sequence file. You can utilize mass storage unit specifier (MSUS) "NVWFM" or use a real full path representation. See the example below. MSUS "NVWFM" is mapped to D: VARB directory on test set hard disk.

Any number of segments, up to a segment count limit of 64, can be used to create a sequence. Repeated segments are included in the count limit.

Each waveform segment name string length upper limit is 128 chars. Please do NOT insert waveform which name string exceeds 128 chars.

The internal source does not support nesting one waveform sequence file into another waveform sequence file.

Remote Command :SOURce:RADio:ARB:SEquence[:MWAVeform] <filename>, <waveform1>, <reps>, NONE | M1 | M2 | M3 | M4 | M1M2 | M1M3 | M1M4 | M2M3 | M2M4 | M3M4 | M1M2M3 | M1M2M4 | M1M3M4 | M2M3M4 | M1M2M3M4 | ALL, {<waveform2>, <reps>, NONE | M1 | M2 | M3 | M4 | M1M2 | M1M3 | M1M4 | M2M3 | M2M4 | M3M4 | M1M2M3 | M1M2M4 | M1M3M4 | M2M3M4 | M1M2M3M4 | ALL, } ...

(For additional description of each item, see Notes below ["For Setup SCPI" on page 435](#) "For Setup SCPI".)

:SOURce:RADio:ARB:SEquence[:MWAVeform]? <filename>

(For additional description of each item, see Notes ["For Query SCPI" on page 436](#) below.)

Example

For setup:

```
>:SOUR:RAD:ARB:SEQ "NVWFM:testSeq1.seq", "NVWFM:wfmSegment1.wfm", 10, M2M3M4, "NVWFM:wfmSegment2.wfm", 20, M1M3
```

Or

```
>:SOUR:RAD:ARB:SEQ "D: VARB\testSeq1.seq", " D: VARB\wfmSegment1.wfm", 10, M2M3M4, " D: VARB\wfmSegment2.wfm", 20, M1M3
```

For query, must specify which waveform sequence file to query.

```
>:SOUR:RAD:ARB:SEQ? "NVWFM:testSeq1.seq"
```

Or

```
>:SOUR:RAD:ARB:SEQ? "D: VARB\testSeq1.seq",
```

Notes**For Setup SCPI**

For the Setup SCPI command, the parameters are:

<filename> - String Type

This variable specifies the path and name for the waveform sequence file. The path supports MSUS (NVWFM) or a real full path representation. See example.

<waveform1> - String Type

This variable specifies the path and name of the first existing waveform segment. The path supports

MSUS (NVWFM) or a real full path representation. See example.

The segment file must reside within ARB playback memory before it can be played by the ARB player.

<reps> - Integer Type

This variable specifies the number of times a segment or sequence plays before moving on to the next segment or sequence.

<marker> - Enum Type

NONE - This choice disables all four markers for the waveform. Disabling markers means that the waveform sequence ignores the segments or sequence marker settings.

M1, M2, M3, M4 - these choices, either individually or a combination of them, enable the markers for the waveform segment or sequence. Markers not specified are ignored for that segment or sequence.

ALL - This choice enables all four markers in the waveform segment or sequence.

<waveform2> - String type.

This variable specifies the name of a second existing waveform segment. The path supports MSUS (NVWFM) and real full path representation both. See example.

The segment file must reside within ARB playback memory before it can be played by the ARB player.

<reps> same as above, for the 2nd waveform segment.

<marker> same as above, for the 2nd waveform segment.

You can insert several waveform segments into a waveform sequence file. Just repeat inserting waveform segments as described above.

Error Checks for Setup SCPI command:

If you do not specify a filename, or you use an unsupported MSUS (that is, not NVWFM), or have an error in the waveform sequence file path, an error is generated.

Notes

Error Checks for Query SCPI command: (Continued)

If the specified waveform sequence file name suffix is not “.seq”, error is generated.

If you use an unsupported MSUS (that is, not NVWFM), or have an error in the waveform segment file path, an error is generated.

If the first specified waveform file cannot be found, an error is generated.

If you nest one waveform sequence file into another waveform sequence file, an error is generated.

If the specified repetition value is larger than 65535 or smaller than 1, an error is generated.

If the specified marker type is unrecognized, an error is generated.

For Query SCPI

For the Query the parameters are:

<filename> - String type.

This variable specifies the path and name of the waveform sequence file being queried. The path supports MSUS (NVWFM) or a real full path representation. See example.

The return value is a <string>, which includes each waveform segment file name, repetitions, and marker type. For example:

>:SOUR:RAD:ARB:SEQ? “NVWFM:testSeq1.seq”,

<“wfmSegment1.wfm, 10, ALL, wfmSegment2.wfm, 20, M1M3”,

Error Checks for Query SCPI command:

If you do not specify a filename, an error is generated.
 If the waveform sequence file name is empty, an error is generated.
 If the specified waveform sequence file cannot be found, an error is generated.

Initial S/W Revision	A.05.00
----------------------	---------

Edit Selected Sequence

Allows access to the sub-menus for editing the sequence currently selected within the Waveform Sequence List view. Pressing this key changes the central view area to display the Waveform Sequence Creation and Editing view.

Key Path	Source, Modulation Setup, ARB, Waveform Sequences
----------	--

Notes	No remote command, front panel only.
-------	--------------------------------------

Initial S/W Revision	A.05.00
----------------------	---------

Current Directory...

Allows you to change the currently selected directory on the hard disk. Pressing this key opens a standard windows change directory dialog and allows you to select the new directory of interest.

Key Path	Source, Modulation Setup, ARB, Waveform Sequences
----------	--

Notes	No remote command, front panel only.
-------	--------------------------------------

Initial S/W Revision	A.05.00
----------------------	---------

Waveform Utilities

Allows you access to the waveform utilities sub-menus.

Key Path	Source, Modulation Setup, ARB
----------	--------------------------------------

Initial S/W Revision	A.05.00
----------------------	---------

Multi-Pack Licenses

Allows you access to the Multi - Pack License sub-menus. Pressing this key also changes the central view area to display the Multi -Pack License Management view.

On modular instrument like E6630A or E6640A, multi-pack license operations are only allowed on the default module, i.e. "Left" module for E6630A or "TRX1" module for E6640A.

Key Path	Source, Modulation Setup, ARB, Waveform Utilities
----------	--

Dependencies	This key is only available if there is at least one Multi-pack license installed on the instrument.
--------------	---

Initial S/W Revision	A.05.00
----------------------	---------

Add Waveform

Pressing this key accesses the Add Waveform sub-menu. It also changes the central display area to display the Multi-Pack License Waveform Add view.

Key Path	Source, Modulation Setup, ARB, Waveform Utilities, Multi-Pack Licenses
Dependencies	This key is only available if there is at least one slot available within at least one multi-pack license.
Initial S/W Revision	A.05.00

Add Waveform

Allows you to add the currently selected waveform segment to a multi-pack license. The new waveform is added to the next available slot regardless of which slot was selected on the Multi-Pack License Management view.

Key Path	Source, Modulation Setup, ARB, Waveform Utilities, Multi-Pack Licenses, Add Waveform
Remote Command	:SYSTem:LKEY:WAVeform:ADD <string> or :SYSTem:LICense[:FPACK]:WAVeform:ADD <string>
Example	SYST:LKEY:WAV:ADD "mywaveform.wfm" or SYST:LIC:WAV:ADD "mywaveform.wfm"
Notes	The second SCPI :SYSTem:LICense[:FPACK]:WAVeform:ADD is provided to be consistent with the style of Keysight signal sources. You can use either one of them. Since adding a waveform segment to a Multi-Pack license causes the license slot to enter the trial period of only 48 hours, pressing this key causes a confirmation dialog to be displayed to ensure you do want to add the waveform segment to the Multi-Pack. If you attempt to license a waveform that is already licensed using another slot an error is generated. .
Dependencies	This key is only available if the currently selected file is a secure waveform requiring a license, and there is at least one slot available within at least one multi-pack license. If the waveform highlighted is a secure waveform, but is already licensed, this key will be unavailable.
Initial S/W Revision	A.05.00

Segments on Hard Disk

Allows you access to the sub-menus for loading waveform segments from the hard disk into ARB memory. The default directory is: D: varb.

Pressing this key changes the current view to the Waveform Management View.

Key Path	Source, Modulation Setup, ARB, Select Waveform
Initial S/W Revision	A.05.00

Load Segment To ARB Memory

Allows you to load the selected file into ARB memory. On the front panel you select the file for loading to the ARB memory by highlighting the desired file in the list. Using the SCPI command, you specify the file name on the HDD.

“NVWFM” (none-volatile storage) MSUS (Mass Storage Unit Specifier) is supported in the memory subsystem because the ARB memory cannot be accessed directly. Therefore, files must be downloaded to the instrument hard disk and then loaded into the ARB memory. “NVWFM” MSUS will be mapped to the default directory D: VARB. The SCPI command supports using either “NVWFM” MSUS or specifying a full path. For more information, see [Memory Subsystem \(Remote Command Only\)](#).

If a file of the same name already exists within ARB memory, it is overwritten. If you wish to load two segments of the same name, you must rename one of the segments before loading it into ARB memory. To rename a segment, you can either use Windows File Explorer, or the :MMEMory:COPI command.

Key Path	Source, Modulation Setup, ARB, Select Waveform, Segments on Hard Disk
Remote Command	:SOURce:RADio:ARB:LOAD <string>
Example	:SOUR:RAD:ARB:LOAD "D: VARB\testwaveform.bin" or :SOUR:RAD:ARB:LOAD "NVWFM:testwaveform.bin"
Notes	<p>Because loading the file involves a delay of unpredictable length, this command should be followed by the query *OPC?, which holds off subsequent commands until the loading operation is complete.</p> <p><string> – specifies the path name of the file to load from the HDD into ARB memory. It could be a <full path + filename>, or <“NVWFM” MSUS + colon + filename>.</p> <p>When in Sequence Analyzer mode, and Include Source is Yes, an attempt to load a file to ARB memory will be rejected with an error.</p> <p>When Include Source is Noand if there is insufficient free ARB memory to load the selected waveform, an error is generated. .</p> <p>If you specify a file over SCPI, but the file is not at the specified location, an error is generated.</p> <p>If you try to load a waveform file but the file contains less than 500 IQ samples, an error is generated.</p> <p>If you try to load a Signal Studio waveform “*.wfm” which contains invalid waveform header, an error is generated.</p> <p>If the ARB is ON when you load a file to ARB memory or delete a file from ARB memory, the playing waveform segment may not keep phase continuity during the ARB memory operation. The waveform will be replayed after the ARB operation is finished.</p> <p>ARB can be loaded into ARB memory even required licenses do not present on the instrument. In this case, a GUI only warning message -800, “Operation complete; Loaded <filename> successfully, but no license <required licenses> installed”. User can install required licenses according to <required licenses> string to license it, or multi-pack license it.</p>
Initial S/W Revision	A.05.00

Load All To ARB Memory

Allows you to load all the segment files within the currently selected directory into ARB memory. If a file of the same name already exists within ARB memory, it is overwritten. If you wish to load two segments of the same name, you must rename one of the segments before loading it into ARB memory. To rename a segment, you can either use Windows File Explorer, or the :MEMory:COpy command.

Key Path	Source, Modulation Setup, ARB, Select Waveform, Segments on Hard Disk
Remote Command	:SOURce:RADio:ARB:LOAD:ALL <string>
Example	:SOUR:RAD:ARB:LOAD:ALL "D: varb"
Notes	<p><string> - specifies the directory on the HDD to load the files into ARB memory from.</p> <p>When in Sequence Analyzer mode, and Include Source is Yes, an attempt to load all files from a directory to ARB memory is rejected with an error.</p> <p>When Include Source is No and there is insufficient free ARB memory to load all the waveforms, when the ARB memory is full, the copy ceases, and an error is generated.</p> <p>If you specify a directory over SCPI, but the directory does not exist, an error is generated.</p> <p>If the ARB is ON, a user then loads or deletes file to ARB memory, the playing waveform segment may not keep phase continuity during the ARB memory operation. The waveform will be replayed after the ARB operation is finished.</p>
Initial S/W Revision	A.05.00

Change Directory...

Allows you to change the currently selected directory on the hard disk. Pressing this key opens a standard windows change directory dialog allowing you to select the new directory of interest.

The current directory is used for manually loading waveform segments into ARB memory for playback, and as a search location for waveform segments that are required to be loaded into ARB memory for playback of a waveform sequence or a list sequence.

Key Path	Source, Modulation Setup, ARB, Select Waveform, Segments on Hard Disk
Notes	No remote command, SCPIfront panel only.
Initial S/W Revision	A.05.00

Default Directory...

Allows you to change the default directory. It is used as a search location for waveform segments that are required to be loaded into ARB memory for playback of a waveform sequence, and as a search location for selecting waveforms using SCPI.

Key Path	Source, Modulation Setup, ARB, Select Waveform, Segments on Hard Disk
Remote Command	:SOURce:RADio:ARB:DEFault:DIRectory <string> :SOURce:RADio:ARB: DEFault:DIRectory?
Example	:SOUR:RAD:ARB:DEF:DIR "D:\ArbFiles"

:SOUR:RAD:ARB:DEF:DIR?

State Saved	Persistent, survives a power cycle and a preset but not saved in the instrument state
Initial S/W Revision	A.05.00

Segments on Hard Disk

This key functions the same as ["Segments on Hard Disk" on page 738](#).

Key Path	Source, Modulation Setup, ARB, Waveform Utilities, Multi-Pack Licenses, Add Waveform
Initial S/W Revision	Prior to A.09.00

Load Segment To ARB Memory

This key functions the same as ["Load Segment To ARB Memory" on page 738](#).

Key Path	Source, Modulation Setup, ARB, Waveform Utilities, Multi-Pack Licenses, Add Waveform, Segment on Hard Drive
Initial S/W Revision	Prior to A.09.00

Load All To ARB Memory

This key functions the same as ["Load All To ARB Memory" on page 739](#).

Key Path	Source, Modulation Setup, ARB, Waveform Utilities, Multi-Pack Licenses, Add Waveform, Segment on Hard Drive
Initial S/W Revision	Prior to A.09.00

Change Directory ...

This key functions the same as ["Change Directory..." on page 740](#).

Key Path	Source, Modulation Setup, ARB, Waveform Utilities, Multi-Pack Licenses, Add Waveform, Segment on Hard Drive
Initial S/W Revision	Prior to A.09.00

Default Directory ...

This key functions the same as ["Default Directory..." on page 740](#)

Key Path	Source, Modulation Setup, ARB, Waveform Utilities, Multi-Pack Licenses, Add Waveform, Segment on Hard Drive
----------	--

Initial S/W Revision	Prior to A.09.00
----------------------	------------------

Replace Waveform

Pressing this key accesses the Replace Waveform submenu. It also changes the central display area to display the Multi-Pack License Waveform Add view.

Key Path	Source, Modulation Setup, ARB, Waveform Utilities, Multi-Pack Licenses
Dependencies	This key is only available if the currently selected slot is in the trial state.
Initial S/W Revision	A.05.00

Replace Waveform

Allows you to replace the waveform in the currently selected slot with the waveform currently selected in the Multi-Pack License Waveform Add view.

Key Path	Source, Modulation Setup, ARB, Waveform Utilities, Multi-Pack Licenses, Replace Waveform
Remote Command	:SYSTem:LKEY:WAVeform:REPLace <int>, <string> or :SYSTem:LiCense[:FPACK]:WAVeform:REPLace <int>, <string>
Example	SYST:LKEY:WAV:REPL 1, "myotherwaveform.wfm" or :SYST:LIC:WAV:REPL 1, "myotherwaveform.wfm"
Notes	The second SCPI :SYSTem:LiCense[:FPACK]:WAVeform:REPLace is provided to be consistent with the style of Keysight signal sources. You can use either one of them. If you attempt to license a waveform that is already licensed using another slot an error is generated. Waveform slot number <int> is positive. If you attempt to input a slot number less than or equals 0, an error is generated.
Initial S/W Revision	A.05.00

Segments on Hard Disk

This key functions the same as ["Segments on Hard Disk" on page 738](#).

Key Path	Source, Modulation Setup, ARB, Waveform Utilities, Multi-Pack Licenses, Replace Waveform
Initial S/W Revision	Prior to A.09.00

Load Segment To ARB Memory

This key functions the same as ["Load Segment To ARB Memory" on page 738](#).

Key Path	Source, Modulation Setup, ARB, Waveform Utilities, Multi-Pack Licenses, Replace Waveform, Segment on Hard Drive
Initial S/W Revision	Prior to A.09.00

Load All To ARB Memory

This key functions the same as ["Load All To ARB Memory" on page 739](#).

Key Path	Source, Modulation Setup, ARB, Waveform Utilities, Multi-Pack Licenses, Replace Waveform, Segment on Hard Drive
Initial S/W Revision	Prior to A.09.00

Change Directory ...

This key functions the same as ["Change Directory..." on page 740](#).

Key Path	Source, Modulation Setup, ARB, Waveform Utilities, Multi-Pack Licenses, Replace Waveform, Segment on Hard Drive
Initial S/W Revision	Prior to A.09.00

Default Directory ...

This key functions the same as ["Default Directory..." on page 740](#)

Key Path	Source, Modulation Setup, ARB, Waveform Utilities, Multi-Pack Licenses, Replace Waveform, Segment on Hard Drive
Initial S/W Revision	Prior to A.09.00

Clear Waveform from Slot

Allows you to clear the waveform from the selected slot.

Key Path	Source, Modulation Setup, ARB, Waveform Utilities, Multi-Pack Licenses
Remote Command	:SYSTem:LKEY:WAVeform:CLEar <int> or :SYSTem:LIcense[:FPACK]:WAVeform:CLEar <int>
Example	SYST:LKEY:WAV:CLE 1 or :SYST:LIC:WAV:CLE 1
Notes	The second SCPI :SYSTem:LIcense[:FPACK]:WAVeform:CLEar is provided to be consistent with the style of Keysight signal sources. You can use either one of them.

Waveform slot number <int> is positive. If you attempt to input a slot number less than or equals 0, an error is generated.

Dependencies This key is only available if the currently selected slot is in the trial state.

Initial S/W Revision A.05.00

Lock Waveform in Slot

If the selected slot is in the trial state or the lock required state, the waveform that occupies the slot is locked and permanently licensed.

Key Path **Source, Modulation Setup, ARB, Waveform Utilities, Multi-Pack Licenses**

Remote Command :SYSTem:LKEY:WAVeform:LOCK <int>
or
:SYSTem:LICense[:FPACK]:WAVeform:LOCK <int>

Example SYST:LKEY:WAV:LOCK 1
or
SYST:LIC:WAV:LOCK 1

Notes The second SCPI :SYSTem:LICense[:FPACK]:WAVeform:LOCK is provided to be consistent with the style of Keysight signal sources. You can use either one of them.
Waveform slot number <int> is positive. If you attempt to input a slot number less than or equals 0, an error is generated.

Dependencies This key is only available if the currently selected slot is in the trial state or the lock required state.

Initial S/W Revision A.05.00

Slot Status Query (Remote Command Only)

Returns the status of the specified slot.

Remote Command :SYSTem:LKEY:WAVeform:STATus? <int>
or
:SYSTem:LICense[:FPACK]:WAVeform:STATus? <int>

Example :SYST:LKEY:WAV:STAT? 1
<"Locked"
or
:SYST:LIC:WAV:STAT? 1
<"Locked"

Notes The second SCPI :SYSTem:LICense[:FPACK]:WAVeform:STATus is provided to be consistent with the style of Keysight signal sources. You can use either one of them.
Waveform slot number <int> is positive. If you attempt to input a slot number less than or equals 0, an error is generated.

	error is generated. Result type is string. If input slot number exceeds total available slot number, "Nonexistent" is returned.
Range	"Locked" "Available" "Trail" "LockRequired" "Nonexistent"
Initial S/W Revision	A.05.00

Slots Free Query (Remote Command Only)

Returns the number of license slots free.

Remote Command	:SYSTem:LKEY:WAVeform:FREE? or :SYSTem:LICense[:FPACK]:WAVeform:FREE?
Example	:SYST:LKEY:WAV:FREE? or :SYST:LIC:WAV:FREE?
Notes	The second SCPI :SYSTem:LICense[:FPACK]:WAVeform:FREE is provided to be consistent with the style of Keysight signal sources. You can use either one of them.
Initial S/W Revision	A.05.00

Slot Used Query (Remote Command Only)

Returns the number of license slots used.

Remote Command	:SYSTem:LKEY:WAVeform:USED? or :SYSTem:LICense[:FPACK]:WAVeform:USED?
Example	:SYST:LKEY:WAV:USED? or :SYST:LIC:WAV:USED?
Notes	The second SCPI :SYSTem:LICense[:FPACK]:WAVeform:USED is provided to be consistent with the style of Keysight signal sources. You can use either one of them.
Initial S/W Revision	A.05.00

Slot Waveform Name Query (Remote Command Only)

Returns the waveform name of the specified slot

Remote Command	:SYSTem:LKEY:WAVeform:NAME? <int> or :SYSTem:LICense[:FPACK]:WAVeform:NAME? <int>
-----------------------	---

Example	:SYST:LKEY:WAV:NAME? 1 <"CDMA2K_22.wfm" or :SYST:LIC:WAV:NAME? 1 <"CDMA2K_22.wfm"
Notes	Waveform slot number <int> is positive. If you attempt to input a slot number less than or equals 0, an error is generated. Result type is string. If input slot number exceeds total available slot number, "Nonexistent" is returned. If no waveform stored in the specified slot, then empty string is returned.
Initial S/W Revision	A.12.00

Slot Waveform Unique ID Query (Remote Command Only)

Returns the waveform unique ID of the specified slot

Remote Command	:SYSTem:LKEY:WAVeform:UID? <int> or :SYSTem:LICense[:FPACK]:WAVeform:UID? <int>
Example	:SYST:LKEY:WAV:UID? 2 <"1346752140" or :SYST:LIC:WAV:UID? 2 <"1346752140"
Notes	Waveform slot number <int> is positive. If you attempt to input a slot number less than or equals 0, an error is generated. Result type is string. If input slot number exceeds total available slot number, "Nonexistent" is returned. If no waveform stored in the specified slot, then "0" is returned
Initial S/W Revision	A.12.00

Locked Waveform Name List Query (Remote Command Only)

Returns the waveform name list of locked.

Remote Command	:SOURce:RADio:ARB:MPLicensed:NAME:LOCKed?
Example	SOUR:RAD:ARB:MPL:NAME:LOCKed? <"CDMA2K_27.wfm", "GSM_MCS1.WFM", "c2kWfm.wfm"
Initial S/W Revision	A.11.00

Locked Waveform Unique ID List Query (Remote Command Only)

Returns the waveform unique id list of locked.

Remote Command	:SOURce:RADio:ARB:MPLicensed:UID:LOCKed?
Example	SOUR:RAD:ARB:MPL:UID:LOCKed? <"2996927136","3812603511","3710986266"
Notes	Each Signal Studio waveform has a unique id recorded in header. So if the unique ids are same, that means they are same one waveform. So besides SCPI to query locked waveform name list, also provide a SCPI to query locked waveform unique id list
Initial S/W Revision	A.11.00

Marker Utilities

Allows access to the marker utilities sub-menus.

Key Path	Source, Modulation Setup, ARB
Initial S/W Revision	A.05.00

Marker Polarity

Allows access to the marker polarity sub-menu, which allows you to specify the polarity for the four markers. For a positive polarity, the marker signal is high during the marker points. For a negative marker polarity, the marker signal is high during the period of no marker points.

Key Path	Source, Modulation Setup, ARB, Marker Utilities
Initial S/W Revision	A.05.00

Mkr 1 Polarity

Allows you to set the polarity of marker 1.

Key Path	Source, Modulation Setup, ARB, Marker Utilities, Marker Polarity
Remote Command	:SOURce:RADio:ARB:MPOLarity:MARKer1 POSitive NEGative :SOURce:RADio:ARB:MPOLarity:MARKer1?
Example	:SOUR:RAD:ARB:MPOL:MARK1 NEG
Dependencies	When a new waveform is selected for playback the settings contained within the associated waveform header file are applied to the ARB. The marker polarity is one of the values stored within the header file. If the newly selected waveform file has an associated header file, the marker polarity is updated with the value from the header file. The marker polarity will remain unchanged if the newly selected waveform does not have an associated header file.
Preset	Pos
Range	Neg Pos
Initial S/W Revision	A.05.00

Mkr 2 Polarity

Allows you to set the polarity of marker 2.

Key Path	Source, Modulation Setup, ARB, Marker Utilities, Marker Polarity
Remote Command	:SOURce:RADio:ARB:MPOLarity:MARKer2 POSitive NEGative :SOURce:RADio:ARB:MPOLarity:MARKer2?
Example	:SOUR:RAD:ARB:MPOL:MARK2 NEG
Dependencies	When a new waveform is selected for playback the settings contained within the associated waveform header file are applied to the ARB. The marker polarity is one of the values stored within the header file. If the newly selected waveform file has an associated header file, the marker polarity is updated with the value from the header file. The marker polarity will remain unchanged if the newly selected waveform does not have an associated header file.
Preset	Pos
Range	Neg Pos
Initial S/W Revision	A.05.00

Mkr 3 Polarity

Allows you to set the polarity of marker 3.

Key Path	Source, Modulation Setup, ARB, Marker Utilities, Marker Polarity
Remote Command	:SOURce:RADio:ARB:MPOLarity:MARKer3 POSitive NEGative :SOURce:RADio:ARB:MPOLarity:MARKer3?
Example	:SOUR:RAD:ARB:MPOL:MARK3 NEG
Dependencies	When a new waveform is selected for playback the settings contained within the associated waveform header file are applied to the ARB. The marker polarity is one of the values stored within the header file. If the newly selected waveform file has an associated header file, the marker polarity is updated with the value from the header file. The marker polarity will remain unchanged if the newly selected waveform does not have an associated header file.
Preset	Pos
Range	Neg Pos
Initial S/W Revision	A.05.00

Mkr 4 Polarity

Allows you to set the polarity of marker 4.

Key Path	Source, Modulation Setup, ARB, Marker Utilities, Marker Polarity
Remote Command	:SOURce:RADio:ARB:MPOLarity:MARKer4 POSitive NEGative :SOURce:RADio:ARB:MPOLarity:MARKer4?

Example	:SOUR:RAD:ARB:MPOL:MARK4 NEG
Dependencies	When a new waveform is selected for playback the settings contained within the associated waveform header file are applied to the ARB. The marker polarity is one of the values stored within the header file. If the newly selected waveform file has an associated header file, the marker polarity is updated with the value from the header file. The marker polarity will remain unchanged if the newly selected waveform does not have an associated header file.
Preset	Pos
Range	Neg Pos
Initial S/W Revision	A.05.00

Marker Routing

Allows access to the marker routing sub-menus, which allow you to specify where the marker events are routed. It should be noted that the markers can also be routed to Trigger 1 Out and Trigger 2 Out, however this must be set up using the menus accessed by pressing the “Trigger” hard key.

Key Path	Source, Modulation Setup, ARB, Marker Utilities
Initial S/W Revision	A.05.00

Pulse/RF Blank

Allows you to select which marker is used for the pulse/RF blanking function. The pulse/RF blanking function blanks the RF when the marker signal goes low. The marker polarity determines when the marker signal is high. For a positive polarity, this is during the marker points. For a negative polarity, this is when there are no marker points.

Marker points should be set before using this function. Enabling this function without setting maker points may create a continuous low or high signal, dependant on the marker polarity. This causes either no RF output, or a continuous RF output.

Key Path	Source, Modulation Setup, ARB, Marker Utilities, Marker Routing
Remote Command	:SOURce:RADio:ARB:MDEStination:PULSe NONE M1 M2 M3 M4 :SOURce:RADio:ARB:MDEStination:PULSe?
Example	:SOUR:RAD:ARB:MDES:PULS NONE
Dependencies	When a new waveform is selected for playback the settings contained within the associated waveform header file are applied to the ARB. The pulse/RF blanking setting is one of the values stored within the header file. If the newly selected waveform file has an associated header file, the pulse/RF blanking setting is updated with the value from the header file. The pulse/RF blanking setting will remain unchanged if the newly selected waveform does not have an associated header file.
Range	None M1 M2 M3 M4
Initial S/W Revision	A.05.00

None

Sets no marker to be used for the pulse/RF blanking function, essentially turning the RF blanking function off.

Key Path	Source, Modulation Setup, ARB, Marker Utilities, Marker Routing, Pulse/RF Blank
Example	:SOUR:RAD:ARB:MDES:PULS NONE
Initial S/W Revision	A.05.00

Marker 1

Sets marker 1 to be used for the pulse/RF blanking function.

Key Path	Source, Modulation Setup, ARB, Marker Utilities, Marker Routing, Pulse/RF Blank
Example	:SOUR:RAD:ARB:MDES:PULS M1
Initial S/W Revision	A.05.00

Marker 2

Sets marker 2 to be used for the pulse/RF blanking function.

Key Path	Source, Modulation Setup, ARB, Marker Utilities, Marker Routing, Pulse/RF Blank
Example	:SOUR:RAD:ARB:MDES:PULS M2
Initial S/W Revision	A.05.00

Marker 3

Sets marker 3 to be used for the pulse/RF blanking function.

Key Path	Source, Modulation Setup, ARB, Marker Utilities, Marker Routing, Pulse/RF Blank
Example	:SOUR:RAD:ARB:MDES:PULS M3
Initial S/W Revision	A.05.00

Marker 4

Sets marker 4 to be used for the pulse/RF blanking function.

Key Path	Source, Modulation Setup, ARB, Marker Utilities, Marker Routing, Pulse/RF Blank
Example	:SOUR:RAD:ARB:MDES:PULS M4
Initial S/W Revision	A.05.00

ALC Hold

Allows you to specify which marker is routed for use within the ALC hold function. The ALC hold marker function holds the ALC circuitry at the average value of the sample points set by the marker.

The ALC hold function operates during the low periods of the marker signal. The marker polarity determines when the marker signal is high. For positive polarity, this is during the marker points. For a negative polarity, this is when there are no marker points.

Key Path	Source, Modulation Setup, ARB, Marker Utilities, Marker Routing
Remote Command	:SOURce:RADio:ARB:MDEStination:ALCHold NONE M1 M2 M3 M4 :SOURce:RADio:ARB:MDEStination:ALCHold?
Example	:SOUR:RAD:ARB:MDES:ALCH NONE
Dependencies	When a new waveform is selected for playback the settings contained within the associated waveform header file are applied to the ARB. The ALC hold setting is one of the values stored within the header file. If the newly selected waveform file has an associated header file, the ALC hold setting is updated with the value from the header file. The ALC hold setting will remain unchanged if the newly selected waveform does not have an associated header file.
Range	None M1 M2 M3 M4
Initial S/W Revision	A.05.00

None

Sets no marker to be used for the ALC hold function, essentially turning the ALC hold function off.

Key Path	Source, Modulation Setup, ARB, Marker Utilities, Marker Routing, ALC Hold
Example	:SOUR:RAD:ARB:MDES:PULS NONE
Initial S/W Revision	A.05.00

Marker 1

Sets marker 1 to be used for the ALC hold function.

Key Path	Source, Modulation Setup, ARB, Marker Utilities, Marker Routing, ALC Hold
Example	:SOUR:RAD:ARB:MDES:PULS M1
Initial S/W Revision	A.05.00

Marker 2

Sets marker 2 to be used for the ALC hold function.

Key Path	Source, Modulation Setup, ARB, Marker Utilities, Marker Routing, ALC Hold
Example	:SOUR:RAD:ARB:MDES:PULS M2
Initial S/W Revision	A.05.00

Marker 3

Sets marker 3 to be used for the ALC hold function.

Key Path	Source, Modulation Setup, ARB, Marker Utilities, Marker Routing, ALC Hold
Example	:SOUR:RAD:ARB:MDES:PULS M3
Initial S/W Revision	A.05.00

Marker 4

Sets marker 4 to be used for the ALC hold function.

Key Path	Source, Modulation Setup, ARB, Marker Utilities, Marker Routing, ALC Hold
Example	:SOUR:RAD:ARB:MDES:PULS M4
Initial S/W Revision	A.05.00

Header Utilities

Allows access to the header utilities sub-menu. Pressing this key also causes the central display area to change to display the File Header Information view.

Key Path	Source, Modulation Setup, ARB
Dependencies	This key is only available if there is currently a waveform selected for playback. If no waveform is selected, the key is grayed out.
Initial S/W Revision	A.05.00

Clear Header

Allows you to clear the header information from the file header associated with the currently selected waveform.

Key Path	Source, Modulation Setup, ARB, Header Utilities
Remote Command	:SOURce:RADio:ARB:HEADer:CLEar
Example	:SOUR:RAD:ARB:HEAD:CLE
Notes	Attempting to clear the header details via SCPI when no waveform was selected for playback will generate an error.
Initial S/W Revision	A.05.00

Save Setup To Header

Allows you to save new file header information details to the file.

Key Path	Source, Modulation Setup, ARB, Header Utilities
Remote Command	:SOURce:RADio:ARB:HEADer:SAVE
Example	:SOUR:RAD:ARB:HEAD:SAVE
Notes	Attempting to save the header details via SCPI when no waveform was selected for playback will generate an error.
Initial S/W Revision	A.05.00
Modified at S/W Revision	A.16.00 (AWGN settings will be saved to header as well)

Query Waveform Unique ID (Remote Command Only)

Each Signal Studio waveform contains a unique waveform ID, which recorded in the header. This command allows you to query the unique waveform ID from the header. This is a SCPI only command. User can also check [Error! Reference source not found.](#) for waveform unique ID display.

Remote Command	:MMEMorY:HEADer:ID? "<file name>"
Example	:MMEM:HEAD:ID? "test.wfm" (query the waveform already loaded into the ARB memory) :MMEM:HEAD:ID? "D: VARB\test.wfm" (query the waveform on the hard disk by absolute path) :MMEM:HEAD:ID? "NVWFM:test.wfm" (query the waveform on the hard disk by MSUS)
Notes	SCPI query only. The queried waveform file can be in ARB memory, or on hard disk. If want to query ARB in ARB memory, then give out the file name directly. If want to query ARB on the hard disk, then absolute file path or MSUS should be given along with the file name. The valid MSUS is "NVWFM" which is mapped to D: VARB on hard disk. If the file cannot be found in ARB memory or on hard disk, an error is generated and value -1 is returned
Initial S/W Revision	A.09.00

Bus Trigger Command (Remote Command Only)

Used to initiate an immediate trigger event if the trigger source is set to Bus.

Remote Command	:SOURce:RADio:ARB:TRIGger:INITiate
Example	:SOUR:RAD:ARB:TRIG:INIT
Initial S/W Revision	A.05.00

AM

Allows access to the menu for configuring the Amplitude Modulation.

Key Path	Source, Modulation Setup
Initial S/W Revision	A.05.00

AM

Enables or disables the amplitude modulation.

Turning AM on when another modulation format is already on results in the previous modulation format being turned off and the generation of an error.

Key Path	Source, Modulation Setup, AM
Remote Command	:SOURce:AM:STATe :SOURce:AM:STATe?
Example	:SOUR:AM:STAT OFF
Preset	Off
Range	On Off
Initial S/W Revision	A.05.00

AM Depth

Allows you to set the amplitude modulation depth in percent.

Key Path	Source, Modulation Setup, AM
Remote Command	:SOURce:AM[:DEPTh] [:LINear] :SOURce:AM[:DEPTh] [:LINear]?
Example	:SOUR:AM 0.1
Preset	0.1 %
Min	0.1 %
Max	95.0 %
Initial S/W Revision	A.05.00

AM Rate

Allows you to set the internal amplitude modulation rate.

Key Path	Source, Modulation Setup, AM
Remote Command	:SOURce:AM:INTernal:FREQuency :SOURce:AM:INTernal:FREQuency?
Example	:SOUR:AM:INT:FREQ 40.0 Hz

Preset	400.0 Hz
Min	10 Hz
Max	40 kHz
Initial S/W Revision	A.05.00

FM

Allows access to the menu for configuring the frequency modulation.

Key Path	Source, Modulation Setup
Initial S/W Revision	A.05.00

FM

Enables or disables the frequency modulation.

Turning FM on when another modulation format is already on results in the previous modulation format being turned off and the generation of an error.

Key Path	Source, Modulation Setup, FM
Remote Command	:SOURce:FM:STATe :SOURce:FM:STATe?
Example	:SOUR:FM:STAT OFF
Preset	Off
Range	On Off
Initial S/W Revision	A.05.00

FM Deviation

Allows you to set the frequency modulation deviation.

Key Path	Source, Modulation Setup, FM
Remote Command	:SOURce:FM[:DEViation] :SOURce:FM[:DEViation]?
Example	:SOUR:FM 1.00 kHz
Preset	1.00 Hz
Min	1.00 Hz
Max	100.00 kHz
Initial S/W Revision	A.05.00

FM Rate

Allows you to set the internal frequency modulation rate.

Key Path	Source, Modulation Setup, FM
Remote Command	:SOURce:FM:INTernal:FREQuency :SOURce:FM:INTernal:FREQuency?
Example	:SOUR:FM:INT:FREQ 40.0 Hz
Preset	400.0 Hz
Min	10 Hz
Max	40 kHz
Initial S/W Revision	A.05.00

PM

Allows access to the menu for configuring the phase modulation.

Key Path	Source, Modulation Setup
Initial S/W Revision	A.05.00

PM

Enables or disables the phase modulation.

Turning PM on when another modulation format is already on results in the previous modulation format being turned off and the generation of an error.

Key Path	Source, Modulation Setup, PM
Remote Command	:SOURce:PM:STATe :SOURce:PM:STATe?
Example	:SOUR:PM:STAT OFF
Preset	Off
Range	On Off
Initial S/W Revision	A.05.00

PM Deviation

Allows you to set the phase modulation deviation.

Key Path	Source, Modulation Setup, PM
Remote Command	:SOURce:PM[:DEViation] :SOURce:PM[:DEViation]?

Example	:SOUR:PM 1.00 rad
Preset	0.1 rad
Min	0.1 rad
Max	20.0 rad
Initial S/W Revision	A.05.00

PM Rate

Allows you to set the internal phase modulation rate.

Key Path	Source, Modulation Setup, PM
Remote Command	:SOURce:PM:INTernal:FREQuency :SOURce:PM:INTernal:FREQuency?
Example	:SOUR:PM:INT:FREQ 40.0 Hz
Preset	400.0 Hz
Min	10 Hz
Max	40 kHz
Initial S/W Revision	A.05.00

List Sequencer

Allows you access to the sub-menus for configuring the list sequencer.

List sequences allows you to enter frequencies and amplitudes at unequal intervals in nonlinear ascending, descending or random order. Each step within the list can also include its own waveform file for playback, step duration, trigger event and trigger output.

The complexities involved in configuring the list sequencer do not lend itself to manual configuration; hence the manual configuration for this feature is limited. For easier configuration of the list sequencer, it is recommended that you use either SCPI or load a tab delimited file containing the setup parameters in a tabular form. The details of the SCPI for configuring the list sequencer can be found in ["Step Configuration \(Remote Command Only\)" on page 746](#).

Once the List Sequencer has been configured using the front panel, SCPI, or loading in a tab delimited file, the sequence must be initiated using the front panel Initiate Sequence key or the corresponding SCPI command.

Key Path	Source
Initial S/W Revision	A.05.00

Sequencer

Allows you to set the state of the list sequencer. When the list sequencer is on, the source is outputting the sequence defined by the sequencer. When the list sequencer is off, the source outputs a single waveform segment or sequence (independent mode) at a single frequency and amplitude.

Key Path	Source, List Sequencer
Remote Command	:SOURce:LIST[:STATe] ON OFF 1 0 :SOURce:LIST[:STATe]?
Example	:SOUR:LIST OFF
Notes	When the sequencer is set to ON, the list sequencer controls the output of the source.
Couplings	When in Sequence Analyzer mode and the list sequencer state is Off, Include Source is forced to No, and the Include Source key is grayed out. When in Sequence Analyzer mode and the list sequencer state is On, Include Source is available to set. And, an ARB memory related operation, like load or delete will be rejected.
Preset	Off
Range	On Off
Initial S/W Revision	A.05.00

Initiate Sequence

Pressing this key arms the sequence for single execution. Once the sequence is armed the source begins the sequence as soon as the trigger is received. If the trigger is set to Free Run, the sequence starts immediately.

Key Path	Source, List Sequencer
Remote Command	:SOURce:LIST:TRIGger[:IMMediate]
Example	:SOUR:LIST:TRIG
Notes	When in Sequence Analyzer mode and Include Source is Yes, the Initiate list sequencer operation is rejected, and the key is grayed out, since source list sequence request is sent to physics via Parallel batch by sequence analyzer. If the file needed by the sequencer is not already in ARB memory, the sequence cannot be initiated and an error will be generated. There is a blocking SCPI query which can be used to query if source list sequence being initiated successfully or not. (see " Query List Sequence Initiation Armed Status (Remote Command Only) " on page 757 Query Source List Sequence Armed Status)
Dependencies	Under the Sequence Analyzer Mode, if Meas Setup->Include Source is set to YES, Source->List Sequencer->Initiate Sequence is disabled.
Initial S/W Revision	A.05.00

List Sequencer Setup

Allows you access to the list sequencer setup menus.

Key Path	Source, List Sequencer
----------	-------------------------------

Number of Steps

Allows you to specify the number of steps within the list sequence.

Key Path	Source, List Sequencer, List Sequencer Setup
Remote Command	:SOURce:LIST:NUMBer:STEPs <integer> :SOURce:LIST:NUMBer:STEPs?
Example	:SOUR:LIST:NUMB:STEP 1
Notes	Increasing the number of steps creates additional steps at the end of the list, with all the settings within the steps set to their default values. Decreasing the number of steps removes steps from the end of the list. The settings within the removed steps are not reset. This means that increasing the number of steps again would allow you to retrieve these steps.
Dependencies	The Step Count parameter is increased or decreased when you insert or delete a point from within the GUI interface to the sequencer.
Preset	1
Min	1
Max	1000
Initial S/W Revision	A.05.00

Current Step

Allows you to select the step number you wish to view or edit.

Key Path	Source, List Sequencer, List Sequencer Setup
Notes	No remote command, front panel only.
Preset	1
Min	1
Max	Step Count
Initial S/W Revision	A.05.00

Insert Step Before

Allows you to insert a new step, containing default values, before the currently selected step. Inserting a step will automatically increase the Step Count parameter by 1. If sequence already reaches upper limit of

1000 steps, then insert more step will be rejected and popup error –221, “Setting Conflict; Cannot insert more steps, maximum number of steps reached”

Key Path	Source, List Sequencer, List Sequencer Setup
Notes	No remote command, front panel only. If the list already contains the maximum limit of 1000 steps, no operation will be made after pressing this key.
Initial S/W Revision	A.05.00

Delete Step

Allows you to delete the current step. Deleting a step will automatically decrease the Step Count parameter by 1. If sequence only has one step left, delete step will be rejected and popup error –221, “Setting conflict; Cannot delete current step, minimum number of steps reached”

Key Path	Source, List Sequencer, List Sequencer Setup
Notes	No remote command, Front Panel key only. If the list already contains the minimum limit of 1 step, no operation will be made after pressing this key
Initial S/W Revision	A.05.00

Clear List

Allows you to clear the list. Clearing the list sets the number of steps to the default value of 1 and sets the parameters for the only step to their default values.

Key Path	Source, List Sequencer, List Sequencer Setup
Initial S/W Revision	A.05.00

Step Trigger

Allows access to the sub-menu for selecting the trigger input for the current step.

Key Path	Source, List Sequencer, List Sequencer Setup
Remote Command	:SOURCE:LIST:STEP[1] 2 3...1000:SETup:INPut:TRIGger IMMEDIATE INTERNAL EXTERNAL2 KEY BUS EXTERNAL4 :SOURCE:LIST:STEP[1] 2 3...1000:SETup:INPut:TRIGger?
Example	:SOUR:LIST:STEP2:SET:INP:TRIG BUS :SOUR:LIST:STEP2:SET:INP:TRIG?
Notes	SCPI is supported after A.09.40
Preset	Free Run
Range	Free Run Internal Manual (Trigger Key) Bus External 2 EXTERNAL4
Initial S/W Revision	A.05.00

Free Run

Sets the trigger input for the current step to Free Run.

Key Path	Source, List Sequencer, List Sequencer Setup, Step Trigger
Example	:SOUR:LIST:STEP2:SET:INP:TRIG IMM
Notes	SCPI is supported after A.09.40
Initial S/W Revision	A.05.00

Internal

Sets the trigger input for the current step to Internal.

Key Path	Source, List Sequencer, List Sequencer Setup, Step Trigger
Example	:SOUR:LIST:STEP2:SET:INP:TRIG INT
Notes	SCPI is supported after A.09.40
Initial S/W Revision	A.05.00

Manual (Trigger Key)

Sets the trigger input for the current step to Manual (Trigger Key). Any step in the sequence set to Manual will cause the sequence execution to stop until the manual trigger key is pressed. Sending the Bus Trigger SCPI command will have no effect. At any point in the sequence where the list sequencer is paused waiting for a software trigger, a pop up dialog is displayed until the trigger event occurs.

Key Path	Source, List Sequencer, List Sequencer Setup, Step Trigger
Example	:SOUR:LIST:STEP2:SET:INP:TRIG KEY
Notes	SCPI is supported after A.09.40
Initial S/W Revision	A.05.00

Bus

Sets the trigger input for the current step to Bus. Any step in the sequence set to Bus will cause the sequence execution to stop until the Bus Trigger SCPI command is sent. Pressing the manual trigger key has no effect. At any point in the sequence where the list sequencer is paused waiting for a software trigger, a pop up dialog is displayed until the trigger event occurs.

Key Path	Source, List Sequencer, List Sequencer Setup, Step Trigger
Example	:SOUR:LIST:STEP2:SET:INP:TRIG BUS
Notes	SCPI is supported after A.09.40
Initial S/W Revision	A.05.00

External 2

Sets the trigger input for the current step to External 2.

Key Path	Source, List Sequencer, List Sequencer Setup, Step Trigger
Example	:SOUR:LIST:STEP2:SET:INP:TRIG EXT2
Notes	SCPI is supported after A.09.40
Notes	Note: When on E6640A, trigger 2 is a bi-directional trigger port. So when trigger 2 has been configured as OUTPUT type, choosing External 2 as the input trigger for the current step will generate error.
Initial S/W Revision	A.05.00

Transition Time

Allows you to specify the transition time for the current step.

The transition time is the amount of time allowed for the source to settle at the current frequency or amplitude value.

Transition Time should not be taken as additional time before or inside the Step Duration. You can set a value for the settling time to allow the source output frequency or amplitude to become stable. Make sure that during this period of time, you do not use the source output signal.

The following table lists recommended values for appropriate settling times to allow for changes within the source.

Value Changed	Recommended Transition Time
Frequency	500 μ s
Amplitude	100 μ s to within 0.1 dB 20 μ s to within 1.0 dB

If the Transition Time value is shorter than the time necessary for the hardware to settle and a List Sequence is initiated, a **warning** is generated.

If the Transition Time value is longer than the Step Duration, an error is generated when initiating a source list sequence. For source list sequence, transition time is included in the step duration length. If the Transition Time value is longer than the Step Duration Time, the real step duration length is extended to equal the transition time and cause a timing shift.

Key Path	Source, List Sequencer, List Sequencer Setup
Remote Command	:SOURce:LIST:STEP[1] 2 3...1000:SETup:TRANsition:TIME <time> :SOURce:LIST:STEP[1] 2 3...1000:SETup:TRANsition:TIME?
Example	:SOUR:LIST:STEP2:SET:TRAN:TIME 1ms :SOUR:LIST:STEP2:SET:TRAN:TIME?

Notes	SCPI is supported after A.09.40
Preset	1.0 ms
Min	0.0 ms
Max	4.0 ks
Initial S/W Revision	A.05.00

Radio Setup

Allows you access to the sub-menus for setting up the radio standard, band, and radio band link direction for the current step.

Key Path	Source, List Sequencer, List Sequencer Setup
Notes	No remote command, front panel only.
Initial S/W Revision	A.05.00

Radio Standard

Allows access to the sub-menus for selecting the radio standard and the associated radio band for use in the current step.

Key Path	Source, List Sequencer, List Sequencer Setup, Radio Setup
Remote Command	:SOURce:LIST:STEP[1] 2 3...1000:SETup:RADio:BAND NONE PGSM EGSM RGSM DCS1800 PCS1900 TGSM810 GSM450 GSM480 GSM700 GSM850 BANDI BANDII BANDIII BANDIV BANDV BANDVI BANDVII BANDVIII BANDIX BANDX BANDXI BANDXII BANDXIII BANDXIV BANDXIX USCELL USPCS JAPAN KOREAN NMT IMT2K UPPER SECOND PAMR400 PAMR800 IMTEXT PCS1DOT9G AWS US2DOT5G PUBLIC LOWER NONE BAND1 BAND2 BAND3 BAND4 BAND5 BAND6 BAND7 BAND8 BAND10 BAND11 BAND12 BAND13 BAND14 BAND17 BAND18 BAND19 BAND20 BAND21 BAND24 BAND25 BAND26 BAND27 BAND28 BAND29 BAND30 BAND31 BAND33 BAND34 BAND35 BAND36 BAND37 BAND38 BAND39 BAND40 BAND41 BAND42 BAND43 BAND44 BANDA BANDB BANDC BANDD BANDE BANDF :SOURce:LIST:STEP[1] 2 3...1000:SETup: RADio:BAND?
Example	:SOUR:LIST:STEP2:SET:RAD:BAND PGSM :SOUR:LIST:STEP2:SET:RAD:BAND?
Notes	SCPI is supported after A.09.40
Initial S/W Revision	A.05.00

None

Selects no radio standard for use on the current step.

Key Path	Source, List Sequencer, List Sequencer Setup, Radio Setup, Radio Standard
Example	:SOUR:LIST:STEP2:SET:RAD:BAND NONE
Notes	SCPI is supported after A.09.40
Initial S/W Revision	A.05.00

GSM/EDGE

Pressing this key once selects GSM/EDGE as the radio standard and the current GSM/EDGE band as the active channel band. Pressing this key again allows access to the sub-menus for selecting a different GSM/EDGE band.

Key Path	Source, List Sequencer, List Sequencer Setup, Radio Setup, Radio Standard
Initial S/W Revision	A.05.00

P-GSM

Selects P-GSM as the band for the current step.

Key Path	Source, List Sequencer, List Sequencer Setup, Radio Setup, Radio Standard, GSM/EDGE
Initial S/W Revision	A.05.00

E-GSM

Selects E-GSM as the band for the current step.

Key Path	Source, List Sequencer, List Sequencer Setup, Radio Setup, Radio Standard, GSM/EDGE
Initial S/W Revision	A.05.00

R-GSM

Selects R-GSM as the band for the current step.

Key Path	Source, List Sequencer, List Sequencer Setup, Radio Setup, Radio Standard, GSM/EDGE
Initial S/W Revision	A.05.00

DCS 1800

Selects DCS 1800 as the band for the current step.

Key Path	Source, List Sequencer, List Sequencer Setup, Radio Setup, Radio Standard, GSM/EDGE
Initial S/W Revision	A.05.00

PCS 1900

Selects PCS 1900 as the band for the current step.

Key Path	Source, List Sequencer, List Sequencer Setup, Radio Setup, Radio Standard, GSM/EDGE
Initial S/W Revision	A.05.00

GSM 450

Selects GSM 450 as the band for the current step.

Key Path	Source, List Sequencer, List Sequencer Setup, Radio Setup, Radio Standard, GSM/EDGE
Initial S/W Revision	A.05.00

GSM 480

Selects GSM 480 as the band for the current step.

Key Path	Source, List Sequencer, List Sequencer Setup, Radio Setup, Radio Standard, GSM/EDGE
Initial S/W Revision	A.05.00

GSM 850

Selects GSM 850 as the band for the current step.

Key Path	Source, List Sequencer, List Sequencer Setup, Radio Setup, Radio Standard, GSM/EDGE
Initial S/W Revision	A.05.00

GSM 700

Selects GSM 700 as the band for the current step.

Key Path	Source, List Sequencer, List Sequencer Setup, Radio Setup, Radio Standard, GSM/EDGE
Initial S/W Revision	A.05.00

T-GSM 810

Selects T-GSM 810 as the band for the current step.

Key Path	Source, List Sequencer, List Sequencer Setup, Radio Setup, Radio Standard, GSM/EDGE
Initial S/W Revision	A.05.00

WCDMA

Pressing this key once selects WCDMA as the radio standard and the current WCDMA band as the active channel band. Pressing this key again allows access to the sub-menus for selecting a different WCDMA band.

Key Path	Source, List Sequencer, List Sequencer Setup, Radio Setup, Radio Standard
Initial S/W Revision	A.05.00

Band I

Selects Band I as the band for the current step.

Key Path	Source, List Sequencer, List Sequencer Setup, Radio Setup, Radio Standard, WCDMA
Initial S/W Revision	A.05.00

Band II

Selects Band II as the band for the current step.

Key Path	Source, List Sequencer, List Sequencer Setup, Radio Setup, Radio Standard, WCDMA
Initial S/W Revision	A.05.00

Band III

Selects Band III as the band for the current step.

Key Path	Source, List Sequencer, List Sequencer Setup, Radio Setup, Radio Standard, WCDMA
Initial S/W Revision	A.05.00

Band IV

Selects Band IV as the band for the current step.

Key Path	Source, List Sequencer, List Sequencer Setup, Radio Setup, Radio Standard, WCDMA
Initial S/W Revision	A.05.00

Band V

Selects Band V as the band for the current step.

Key Path	Source, List Sequencer, List Sequencer Setup, Radio Setup, Radio Standard, WCDMA
Initial S/W Revision	A.05.00

Band VI

Selects Band VI as the band for the current step.

Key Path	Source, List Sequencer, List Sequencer Setup, Radio Setup, Radio Standard, WCDMA
Initial S/W Revision	A.05.00

Band VII

Selects Band VII as the band for the current step.

Key Path	Source, List Sequencer, List Sequencer Setup, Radio Setup, Radio Standard, WCDMA
Initial S/W Revision	A.05.00

Band VIII

Selects Band VIII as the band for the current step.

Key Path	Source, List Sequencer, List Sequencer Setup, Radio Setup, Radio Standard, WCDMA
Initial S/W Revision	A.05.00

Band IX

Selects Band IX as the band for the current step.

Key Path	Source, List Sequencer, List Sequencer Setup, Radio Setup, Radio Standard, WCDMA
Initial S/W Revision	A.05.00

Band X

Selects Band X as the band for the current step.

Key Path	Source, List Sequencer, List Sequencer Setup, Radio Setup, Radio Standard, WCDMA
Initial S/W Revision	A.05.00

Band XI

Selects Band XI as the band for the current step.

Key Path	Source, List Sequencer, List Sequencer Setup, Radio Setup, Radio Standard, WCDMA
Initial S/W Revision	A.05.00

Band XII

Selects Band XII as the band for the current step.

Key Path	Source, List Sequencer, List Sequencer Setup, Radio Setup, Radio Standard, WCDMA
Initial S/W Revision	A.05.00

Band XIII

Selects Band XIII as the band for the current step.

Key Path	Source, List Sequencer, List Sequencer Setup, Radio Setup, Radio Standard, WCDMA
Initial S/W Revision	A.05.00

Band XIV

Selects Band XIV as the band for the current step.

Key Path	Source, List Sequencer, List Sequencer Setup, Radio Setup, Radio Standard, WCDMA
Initial S/W Revision	A.05.00

CDMA 2000 / 1xEVDO

Pressing this key once selects CDMA 2000/1xEVDO as the radio standard and the current CDMA 2000/1xEVDO band as the active channel band. Pressing this key again allows access to the sub-menus for selecting a different CDMA 2000/1xEVDO band.

Key Path	Source, List Sequencer, List Sequencer Setup, Radio Setup, Radio Standard
Initial S/W Revision	A.05.00

US CELL

Selects US Cell as the band for the current step.

Key Path	Source, List Sequencer, List Sequencer Setup, Radio Setup, Radio Standard, CDMA 2000 / 1xEVDO
Initial S/W Revision	A.05.00

US PCS

Selects US PCS as the band for the current step.

Key Path	Source, List Sequencer, List Sequencer Setup, Radio Setup, Radio Standard, CDMA 2000 / 1xEVDO
Initial S/W Revision	A.05.00

Japan Cell

Selects Japan Cell as the band for the current step.

Key Path	Source, List Sequencer, List Sequencer Setup, Radio Setup, Radio Standard, CDMA 2000 / 1xEVDO
Initial S/W Revision	A.05.00

Korean PCS

Selects Korean PCS as the band for the current step.

Key Path	Source, List Sequencer, List Sequencer Setup, Radio Setup, Radio Standard, CDMA 2000 / 1xEVDO
Initial S/W Revision	A.05.00

NMT 450

Selects NMT 450 as the band for the current step.

Key Path	Source, List Sequencer, List Sequencer Setup, Radio Setup, Radio Standard, CDMA 2000 / 1xEVDO
Initial S/W Revision	A.05.00

IMT 2000

Selects IMT 2000 as the band for the current step.

Key Path	Source, List Sequencer, List Sequencer Setup, Radio Setup, Radio Standard, CDMA 2000 / 1xEVDO
Initial S/W Revision	A.05.00

Upper 700

Selects Upper 700 as the band for the current step.

Key Path	Source, List Sequencer, List Sequencer Setup, Radio Setup, Radio Standard, CDMA 2000 / 1xEVDO
Initial S/W Revision	A.05.00

Secondary 800

Selects Secondary 800 as the band for the current step.

Key Path	Source, List Sequencer, List Sequencer Setup, Radio Setup, Radio Standard, CDMA 2000 / 1xEVDO
Initial S/W Revision	A.05.00

400 Euro PAMR

Selects 400 Euro PAMR as the band for the current step.

Key Path	Source, List Sequencer, List Sequencer Setup, Radio Setup, Radio Standard, CDMA 2000 / 1xEVDO
Initial S/W Revision	A.05.00

800 PAMR

Selects 800 PAMR as the band for the current step.

Key Path	Source, List Sequencer, List Sequencer Setup, Radio Setup, Radio Standard, CDMA 2000 / 1xEVDO
Initial S/W Revision	A.05.00

2.5GHz IMT EXT

Selects 2.5 GHz IMT EXT as the band for the current step.

Key Path	Source, List Sequencer, List Sequencer Setup, Radio Setup, Radio Standard, CDMA 2000 / 1xEVDO
Initial S/W Revision	A.05.00

US PCS 1.9GHz

Selects US PCS 1.9 GHz as the band for the current step.

Key Path	Source, List Sequencer, List Sequencer Setup, Radio Setup, Radio Standard, CDMA 2000 / 1xEVDO
Initial S/W Revision	A.05.00

AWS

Selects AWS as the band for the current step.

Key Path	Source, List Sequencer, List Sequencer Setup, Radio Setup, Radio Standard, CDMA 2000 / 1xEVDO
Initial S/W Revision	A.05.00

US 2.5GHz

Selects US 2.5 GHz as the band for the current step.

Key Path	Source, List Sequencer, List Sequencer Setup, Radio Setup, Radio Standard, CDMA 2000 / 1xEVDO
Initial S/W Revision	A.05.00

700 Public Safety

Selects 700 Public Safety as the band for the current step.

Key Path	Source, List Sequencer, List Sequencer Setup, Radio Setup, Radio Standard, CDMA 2000 / 1xEVDO
Initial S/W Revision	A.05.00

C2K Lower 700

Selects C2K Lower 700 as the band for the current step.

Key Path	Source, List Sequencer, List Sequencer Setup, Radio Setup, Radio Standard, CDMA 2000 / 1xEVDO
Initial S/W Revision	A.05.00

LTE

Pressing this key once selects LTE FDD as the radio standard and the current LTE FDD band as the active channel band. Pressing this key again allows access to the sub-menus for selecting a different LTE FDD band.

Key Path	Source, List Sequencer, List Sequencer Setup, Radio Setup, Radio Standard
Initial S/W Revision	A.09.50

BAND 1

Selects BAND 1 as the band for the current step.

Key Path	Source, List Sequencer, List Sequencer Setup, Radio Setup, Radio Standard, LTE
Initial S/W Revision	A.09.50

BAND 2

Selects BAND 2 as the band for the current step.

Key Path	Source, List Sequencer, List Sequencer Setup, Radio Setup, Radio Standard, LTE
Initial S/W Revision	A.09.50

BAND 3

Selects BAND 3 as the band for the current step.

Key Path	Source, List Sequencer, List Sequencer Setup, Radio Setup, Radio Standard, LTE
Initial S/W Revision	A.09.50

BAND 4

Selects BAND 4 as the band for the current step.

Key Path	Source, List Sequencer, List Sequencer Setup, Radio Setup, Radio Standard, LTE
Initial S/W Revision	A.09.50

BAND 5

Selects BAND 5 as the band for the current step.

Key Path	Source, List Sequencer, List Sequencer Setup, Radio Setup, Radio Standard, LTE
Initial S/W Revision	A.09.50

BAND 6

Selects BAND 6 as the band for the current step.

Key Path	Source, List Sequencer, List Sequencer Setup, Radio Setup, Radio Standard, LTE
Initial S/W Revision	A.09.50

BAND 7

Selects BAND 7 as the band for the current step.

Key Path	Source, List Sequencer, List Sequencer Setup, Radio Setup, Radio Standard, LTE
Initial S/W Revision	A.09.50

BAND 8

Selects BAND 8 as the band for the current step.

Key Path	Source, List Sequencer, List Sequencer Setup, Radio Setup, Radio Standard, LTE
Initial S/W Revision	A.09.50

BAND 9

Selects BAND 9 as the band for the current step.

Key Path	Source, List Sequencer, List Sequencer Setup, Radio Setup, Radio Standard, LTE
Initial S/W Revision	A.09.50

BAND 10

Selects BAND 10 as the band for the current step.

Key Path	Source, List Sequencer, List Sequencer Setup, Radio Setup, Radio Standard, LTE
Initial S/W Revision	A.09.50

BAND 11

Selects BAND 11 as the band for the current step.

Key Path	Source, List Sequencer, List Sequencer Setup, Radio Setup, Radio Standard, LTE
Initial S/W Revision	A.09.50

BAND 12

Selects BAND 12 as the band for the current step.

Key Path	Source, List Sequencer, List Sequencer Setup, Radio Setup, Radio Standard, LTE
Initial S/W Revision	A.09.50

BAND 13

Selects BAND 13 as the band for the current step.

Key Path	Source, List Sequencer, List Sequencer Setup, Radio Setup, Radio Standard, LTE
Initial S/W Revision	A.09.50

BAND 14

Selects BAND 14 as the band for the current step.

Key Path	Source, List Sequencer, List Sequencer Setup, Radio Setup, Radio Standard, LTE
Initial S/W Revision	A.09.50

BAND 17

Selects BAND 17 as the band for the current step.

Key Path	Source, List Sequencer, List Sequencer Setup, Radio Setup, Radio Standard, LTE
Initial S/W Revision	A.09.50

BAND 18

Selects BAND 18 as the band for the current step.

Key Path	Source, List Sequencer, List Sequencer Setup, Radio Setup, Radio Standard, LTE
Initial S/W Revision	A.09.50

BAND 19

Selects BAND 19 as the band for the current step.

Key Path	Source, List Sequencer, List Sequencer Setup, Radio Setup, Radio Standard, LTE
Initial S/W Revision	A.09.50

BAND 20

Selects BAND 20 as the band for the current step.

Key Path	Source, List Sequencer, List Sequencer Setup, Radio Setup, Radio Standard, LTE
Initial S/W Revision	A.09.50

BAND 21

Selects BAND 21 as the band for the current step.

Key Path	Source, List Sequencer, List Sequencer Setup, Radio Setup, Radio Standard, LTE
Initial S/W Revision	A.09.50

BAND 24

Selects BAND 24 as the band for the current step.

Key Path	Source, List Sequencer, List Sequencer Setup, Radio Setup, Radio Standard, LTE
Initial S/W Revision	A.09.50

BAND 25

Selects BAND 25 as the band for the current step.

Key Path	Source, List Sequencer, List Sequencer Setup, Radio Setup, Radio Standard, LTE
Initial S/W Revision	A.09.50

BAND 26

Selects BAND 26 as the band for the current step.

Key Path	Source, List Sequencer, List Sequencer Setup, Radio Setup, Radio Standard, LTE
Initial S/W Revision	A.12.53

BAND 27

Selects BAND 27 as the band for the current step.

Key Path	Source, List Sequencer, List Sequencer Setup, Radio Setup, Radio Standard, LTE
Initial S/W Revision	A.14.00

BAND 28

Selects BAND 28 as the band for the current step.

Key Path	Source, List Sequencer, List Sequencer Setup, Radio Setup, Radio Standard, LTE
Initial S/W Revision	A.14.00

BAND 31

Selects BAND 31 as the band for the current step.

Key Path	Source, List Sequencer, List Sequencer Setup, Radio Setup, Radio Standard, LTE
Initial S/W Revision	A.14.00

LTE TDD

Sets LTE TDD as the radio standard for use and accesses the LTE TDD specific channel band sub-menus..

Key Path	Source, Frequency, Radio Setup, Radio Standard
Initial S/W Revision	A.11.50

BAND 33

Selects BAND 33 as the band for the current step.

Key Path	Source, Frequency, Radio Setup, Radio Standard, LTE TDD
Example	:SOUR:FREQ:CHAN:BAND BAND33
Initial S/W Revision	A.11.50

BAND 34

Selects BAND 34 as the band for the current step.

Key Path	Source, Frequency, Radio Setup, Radio Standard, LTE TDD
Example	:SOUR:FREQ:CHAN:BAND BAND34
Initial S/W Revision	A.11.50

BAND 35

Selects BAND 35 as the band for the current step.

Key Path	Source, Frequency, Radio Setup, Radio Standard, LTE TDD
Example	:SOUR:FREQ:CHAN:BAND BAND35
Initial S/W Revision	A.11.50

BAND 36

Selects BAND 36 as the band for the current step.

Key Path	Source, Frequency, Radio Setup, Radio Standard, LTE TDD
Example	:SOUR:FREQ:CHAN:BAND BAND36
Initial S/W Revision	A.11.50

BAND 37

Selects BAND 37 as the band for the current step.

Key Path	Source, Frequency, Radio Setup, Radio Standard, LTE TDD
Example	:SOUR:FREQ:CHAN:BAND BAND37
Initial S/W Revision	A.11.50

BAND 38

Selects BAND 38 as the band for the current step.

Key Path	Source, Frequency, Radio Setup, Radio Standard, LTE TDD
Example	:SOUR:FREQ:CHAN:BAND BAND38
Initial S/W Revision	A.11.50

BAND 39

Selects BAND 39 as the band for the current step.

Key Path	Source, Frequency, Radio Setup, Radio Standard, LTE TDD
Example	:SOUR:FREQ:CHAN:BAND BAND39
Initial S/W Revision	A.11.50

BAND 40

Selects BAND 40 as the band for the current step.

Key Path	Source, Frequency, Radio Setup, Radio Standard, LTE TDD
Example	:SOUR:FREQ:CHAN:BAND BAND40
Initial S/W Revision	A.11.50

BAND 41

Selects BAND 41 as the band for the current step.

Key Path	Source, Frequency, Radio Setup, Radio Standard, LTE TDD
Example	:SOUR:FREQ:CHAN:BAND BAND41
Initial S/W Revision	A.11.50

BAND 42

Selects BAND 42 as the band for the current step.

Key Path	Source, Frequency, Radio Setup, Radio Standard, LTE TDD
Example	:SOUR:FREQ:CHAN:BAND BAND42
Initial S/W Revision	A.11.50

BAND 43

Selects BAND 43 as the band for the current step.

Key Path	Source, Frequency, Radio Setup, Radio Standard, LTE TDD
Example	:SOUR:FREQ:CHAN:BAND BAND43
Initial S/W Revision	A.11.50

BAND 44

Selects BAND 44 as the band for the current step.

Key Path	Source, List Sequencer, List Sequencer Setup, Radio Setup, Radio Standard, LTE TDD
Initial S/W Revision	A.14.00

TDSCDMA

Sets TDSCDMA as the radio standard for use and accesses the TDSCDMA specific channel band sub-menus..

Key Path	Source, Frequency, Radio Setup, Radio Standard
Initial S/W Revision	A.11.50

BAND A

Selects BAND A as the band for the current step.

Key Path	Source, Frequency, Radio Setup, Radio Standard, TDSCDMA
Example	:SOUR:FREQ:CHAN:BAND BANDA
Initial S/W Revision	A.11.50

BAND B

Selects BAND B as the band for the current step.

Key Path	Source, Frequency, Radio Setup, Radio Standard, TDSCDMA
Example	:SOUR:FREQ:CHAN:BAND BANDB
Initial S/W Revision	A.11.50

BAND C

Selects BAND C as the band for the current step.

Key Path	Source, Frequency, Radio Setup, Radio Standard, TDSCDMA
Example	:SOUR:FREQ:CHAN:BAND BANDC
Initial S/W Revision	A.11.50

BAND D

Selects BAND D as the band for the current step.

Key Path	Source, Frequency, Radio Setup, Radio Standard, TDSCDMA
Example	:SOUR:FREQ:CHAN:BAND BANDD
Initial S/W Revision	A.11.50

BAND E

Selects BAND E as the band for the current step.

Key Path	Source, Frequency, Radio Setup, Radio Standard, TDSCDMA
Example	:SOUR:FREQ:CHAN:BAND BANDE
Initial S/W Revision	A.11.50

BAND F

Selects BAND F as the band for the current step.

Key Path	Source, Frequency, Radio Setup, Radio Standard, TDSCDMA
Example	:SOUR:FREQ:CHAN:BAND BANDF
Initial S/W Revision	A.11.50

Radio Band Link

Allows you to specify the radio band link direction for the steps within the list sequence. The link is used in conjunction with the channel band and channel number to determine the output frequency.

When set to “Uplink”, the source will calculate the uplink frequency according to an uplink formula together with selected channel band and channel number. When set to “Downlink”, the source will calculate the downlink frequency according to a downlink formula together with selected channel band and channel number.

Key Path	Source, List Sequencer, List Sequencer Setup, Radio Setup
Remote Command	:SOURce:LIST:STEP[1] 2 3...1000:SETup:RADio:BAND:LINK DOWN UP :SOURce:LIST:STEP[1] 2 3...1000:SETup:RADio:BAND:LINK?

Example	:SOUR:LIST:STEP2:SET:RAD:BAND:LINK UP :SOUR:LIST:STEP2:SET:RAD:BAND:LINK?
Notes	SCPI is supported after A.09.40
Preset	DOWN
Range	DOWN UP
Initial S/W Revision	A.05.00

Channel

Allows you to specify the frequency of the current step via a channel number.

Key Path	Source, List Sequencer, List Sequencer Setup
Remote Command	:SOURce:LIST:STEP[1] 2 3...1000:SETup:CNFRfrequency <double> :SOURce:LIST:STEP[1] 2 3...1000:SETup:CNFRfrequency?
Example	:SOUR:LIST:STEP2:SET:CNFR 124 :SOUR:LIST:STEP2:SET:CNFR?
Notes	SCPI is supported after A.09.40. This SCPI is used to setup channel number or frequency setting, according to current Radio Band setting. If Radio Band is "NONE", then it's frequency. If Radio Band is not "NONE", then it's channel number.
Couplings	The channel number is coupled to the step frequency value. When the step frequency value is changed, the channel number will increase or decrease to match the new step frequency. If the step frequency is not at an exact match for a channel number, the nearest channel number is displayed, along with a greater than, or less than sign to indicate the frequency is above or below the channel number.
Preset	1
Min	0 (Please refer to for valid ranges.)
Max	10838 (Please refer to for valid ranges.)
Initial S/W Revision	A.05.00

Frequency

Allows you to specify a frequency value for the current step.

Key Path	Source, List Sequencer, List Sequencer Setup
Remote Command	:SOURce:LIST:STEP[1] 2 3...1000:SETup:CNFRfrequency <double> :SOURce:LIST:STEP[1] 2 3...1000:SETup:CNFRfrequency?
Example	:SOUR:LIST:STEP2:SET:CNFR 1GHz :SOUR:LIST:STEP2:SET:CNFR?
Notes	SCPI is supported after A.09.40.

	This SCPI is used to setup channel number or frequency setting, according to current Radio Band setting. If Radio Band is "NONE", then it's frequency. If Radio Band is not "NONE", then it's channel number.
Couplings	The frequency value is coupled to the channel band and number for the step, such that updates to the radio band and channel number will update the frequency value to the corresponding absolute frequency. The reverse is also true, changing the frequency value causes the value of the channel number to be updated.
Preset	1.00 GHz
Min	10.00 MHz
Max	Hardware Dependant: Option 503 = 3.6 GHz Option 504 = 3.9 GHz Option 506 = 6.00 GHz
Initial S/W Revision	A.05.00

Power

Allows you to specify a power value for the current step.

Key Path	Source, List Sequencer, List Sequencer Setup
Remote Command	:SOURce:LIST:STEP[1] 2 3...1000:SETup:AMPLitude <double> :SOURce:LIST:STEP[1] 2 3...1000:SETup:AMPLitude?
Example	:SOUR:LIST:STEP2:SET:AMPL -50dBm :SOUR:LIST:STEP2:SET:AMPL?
Notes	SCPI is supported after A.09.40
Notes	Amplitude corrections can be specified for use with the source. In the event of amplitude corrections being applied, the valid ranges for the RF power do not change dependant on the current amplitude correction setting. Instead, if the combination of RF power + amplitude correction is higher or lower than the source output range, the Source Unleveled bit is set and the "Source Unleveled" indicator will appear on status panel to indicate that the source cannot maintain the output power that has been requested. The multiport adapter RFIO TX ports and GPS ports cannot ensure power accuracy when power setting is lower than -130dBm, this power setting value is defined by the sum of RF Power setting and related amplitude correction value. But user settable value could be lower than this limit. When application detected there exists power setting lower than -130dBm on MPA RFIO TX ports, then popup warning message . When application detected there exists power setting lower than -130dBm on MPA GPS ports, then popup warning message . These are only warning messages, and check is performed when RF is ON.
Notes	The Min and Max value here defined UI settable amplitude range. This range is larger than actual amplitude range with level accuracy defined in spec.
Dependencies	The RF power is dependent on the RF output port and frequency, such that the current frequency and selected output port determine the valid range of power values.
Preset	-100 dBm

Min	The range of values depends on the current frequency and selected RF output port. Please refer to "RF Power" on page 627 and the table RF Power Range for the valid ranges.
Max	The range of values depends on the current frequency and selected RF output port. Please refer to "RF Power" on page 627 and the table RF Power Range for the valid ranges.
Initial S/W Revision	A.05.00

Waveform

Allows you access to the sub-menus for selecting the waveform to be played back during the current step. Pressing this key also changes the central display area to show the Waveform File Selection view.

Key Path	Source, List Sequencer, List Sequencer Setup
Remote Command	:SOURce:LIST:STEP[1] 2 3...1000:SETup:WAVEform <string> :SOURce:LIST:STEP[1] 2 3...1000:SETup:WAVEform?
Example	:SOUR:LIST:STEP2:SET:WAV "CW" :SOUR:LIST:STEP2:SET:WAV?
Notes	SCPI is supported after A.09.40
Remote Command Notes	String type, takes "Off" "CW" "Cont" "waveform name"
Preset	CW
Range	Waveform Continue Previous CW Off
Initial S/W Revision	A.05.00

CW

Sets the current step to output a CW tone.

Key Path	Source, List Sequencer, List Sequencer Setup, Waveform
Example	:SOUR:LIST:STEP2:SET:WAV "CW"
Notes	SCPI is supported after A.09.40
Initial S/W Revision	A.05.00

Selected Waveform

Inserts the currently selected waveform in the waveform selection view as the waveform for playback during the current step.

Key Path	Source, List Sequencer, List Sequencer Setup, Waveform
Example	:SOUR:LIST:STEP2:SET:WAV "waveform name"
Notes	SCPI is supported after A.09.40 If the selected waveform contains header (which contains ARB play parameters), source list

sequence will automatically apply header settings of the selected waveform in that step.

Initial S/W Revision	A.05.00
----------------------	---------

Continue Previous

Sets the current step to continue with playback of the waveform from the previous step. When continuing the previous waveform, the ARB playback will not pause while the source retunes to the new frequency or amplitude that may be defined for the new step.

Key Path	Source, List Sequencer, List Sequencer Setup, Waveform
----------	---

Example	:SOUR:LIST:STEP2:SET:WAV "Cont"
----------------	---------------------------------

Notes	SCPI is supported after A.09.40
-------	---------------------------------

Initial S/W Revision	A.05.00
----------------------	---------

Off

Disable RF output of the current step.

Key Path	Source, List Sequencer, List Sequencer Setup, Waveform
----------	---

Example	:SOUR:LIST:STEP2:SET:WAV "Off"
----------------	--------------------------------

Notes	SCPI is supported after A.09.40
-------	---------------------------------

Initial S/W Revision	A.05.00
----------------------	---------

Segments on Hard Disk

Allows you access to the sub-menus for loading waveform segments from the hard disk into ARB memory. The default directory is: D: varb.

Pressing this key changes the current view to the Waveform Management View.

Key Path	Source, Modulation Setup, ARB, Select Waveform
----------	---

Initial S/W Revision	A.05.00
----------------------	---------

Load Segment To ARB Memory

Allows you to load the selected file into ARB memory. On the front panel you select the file for loading to the ARB memory by highlighting the desired file in the list. Using the SCPI command, you specify the file name on the HDD.

"NVWFM" (none-volatile storage) MSUS (Mass Storage Unit Specifier) is supported in the memory subsystem because the ARB memory cannot be accessed directly. Therefore, files must be downloaded to the instrument hard disk and then loaded into the ARB memory. "NVWFM" MSUS will be mapped to the

default directory D: VARB. The SCPI command supports using either “NVWFM” MSUS or specifying a full path. For more information, see [Memory Subsystem \(Remote Command Only\)](#).

If a file of the same name already exists within ARB memory, it is overwritten. If you wish to load two segments of the same name, you must rename one of the segments before loading it into ARB memory. To rename a segment, you can either use Windows File Explorer, or the :MMEMory:COPI command.

Key Path	Source, Modulation Setup, ARB, Select Waveform, Segments on Hard Disk
Remote Command	:SOURce:RADio:ARB:LOAD <string>
Example	:SOUR:RAD:ARB:LOAD “D: VARB\testwaveform.bin” or :SOUR:RAD:ARB:LOAD “NVWFM:testwaveform.bin”
Notes	<p>Because loading the file involves a delay of unpredictable length, this command should be followed by the query *OPC?, which holds off subsequent commands until the loading operating is complete.</p> <p><string> – specifies the path name of the file to load from the HDD into ARB memory. It could be a <full path + filename>, or <“NVWFM” MSUS + colon + filename>.</p> <p>When in Sequence Analyzer mode, and Include Source is Yes, an attempt to load a file to ARB memory will be rejected with an error.</p> <p>When Include Source is No and if there is insufficient free ARB memory to load the selected waveform, an error is generated. .</p> <p>If you specify a file over SCPI, but the file is not at the specified location, an error is generated.</p> <p>If you try to load a waveform file but the file contains less than 500 IQ samples, an error is generated.</p> <p>If you try to load a Signal Studio waveform “*.wfm” which contains invalid waveform header, an error is generated.</p> <p>If the ARB is ON when you load a file to ARB memory or delete a file from ARB memory, the playing waveform segment may not keep phase continuity during the ARB memory operation. The waveform will be replayed after the ARB operation is finished.</p> <p>ARB can be loaded into ARB memory even required licenses do not present on the instrument. In this case, a GUI only warning message –800, “Operation complete; Loaded <filename> successfully, but no license <required licenses> installed”. User can install required licenses according to <required licenses> string to license it, or multi-pack license it.</p>
Initial S/W Revision	A.05.00

Load All To ARB Memory

Allows you to load all the segment files within the currently selected directory into ARB memory. If a file of the same name already exists within ARB memory, it is overwritten. If you wish to load two segments of the same name, you must rename one of the segments before loading it into ARB memory. To rename a segment, you can either use Windows File Explorer, or the :MEMory:COPI command.

Key Path	Source, Modulation Setup, ARB, Select Waveform, Segments on Hard Disk
Remote Command	:SOURce:RADio:ARB:LOAD:ALL <string>
Example	:SOUR:RAD:ARB:LOAD:ALL “D: varb”
Notes	<p><string> - specifies the directory on the HDD to load the files into ARB memory from.</p> <p>When in Sequence Analyzer mode, and Include Source is Yes, an attempt to load all files from a</p>

directory to ARB memory is rejected with an error.

When Include Source is No and there is insufficient free ARB memory to load all the waveforms, when the ARB memory is full, the copy ceases, and an error is generated.

If you specify a directory over SCPI, but the directory does not exist, an error is generated.

If the ARB is ON, a user then loads or deletes file to ARB memory, the playing waveform segment may not keep phase continuity during the ARB memory operation. The waveform will be replayed after the ARB operation is finished.

Initial S/W Revision	A.05.00
----------------------	---------

Change Directory...

Allows you to change the currently selected directory on the hard disk. Pressing this key opens a standard windows change directory dialog allowing you to select the new directory of interest.

The current directory is used for manually loading waveform segments into ARB memory for playback, and as a search location for waveform segments that are required to be loaded into ARB memory for playback of a waveform sequence or a list sequence.

Key Path	Source, Modulation Setup, ARB, Select Waveform, Segments on Hard Disk
Notes	No remote command, SCPI front panel only.
Initial S/W Revision	A.05.00

Default Directory...

Allows you to change the default directory. It is used as a search location for waveform segments that are required to be loaded into ARB memory for playback of a waveform sequence, and as a search location for selecting waveforms using SCPI.

Key Path	Source, Modulation Setup, ARB, Select Waveform, Segments on Hard Disk
Remote Command	:SOURce:RADio:ARB:DEFault:DIRectory <string> :SOURce:RADio:ARB: DEFault:DIRectory?
Example	:SOUR:RAD:ARB:DEF:DIR "D:\ArbFiles" :SOUR:RAD:ARB:DEF:DIR?
State Saved	Persistent, survives a power cycle and a preset but not saved in the instrument state
Initial S/W Revision	A.05.00

Segments in ARB Memory

Allows you access to the sub-menus for managing the files within ARB memory.

Key Path	Source, Modulation Setup, ARB, Select Waveform
Initial S/W Revision	A.05.00

Delete Segment From ARB Mem

Allows you to remove a segment from ARB playback memory.

Key Path	Source, Modulation Setup, ARB, Select Waveform, Segments in ARB Memory
Remote Command	:SOURce:RADio:ARB:DELeTe <string>
Example	:SOUR:RAD:ARB:DEL "testwaveform.bin"
Notes	<p><string> - specifies the waveform to be deleted from the ARB playback memory.</p> <p>When in Sequence Analyzer mode and Include Source is Yes, an attempt to delete a file from ARB memory is rejected with an error.</p> <p>When Include Source is No and you specify a file that does not exist within ARB memory, an error is generated.</p> <p>It is possible to delete files from within the ARB memory when the ARB is ON. However, if you attempt to delete the file that is currently playing an error is generated.</p> <p>It is possible to delete a file from within the ARB memory when the sequencer state is ON and the file is not being used by the List Sequencer. If you attempt to delete a file which is being used by the list sequencer, an error is generated.</p> <p>When sequencer state is On, even if ARB state is On, the selected waveform will not be played. In this case, if the selected waveform is not used in List Sequence, it can be deleted and the ARB state is turned Off.</p> <p>If the ARB is ON and you load a file to ARB memory or delete a file from ARB memory, the playing waveform segment may not keep phase continuity during the ARB memory operation. The waveform will be replayed after the ARB operation is finished.</p>
Initial S/W Revision	A.05.00

Delete All From ARB Memory

Allows you to remove all segments from ARB playback memory.

Key Path	Source, Modulation Setup, ARB, Select Waveform, Segments in ARB Memory
Remote Command	:SOURce:RADio:ARB:DELeTe:ALL
Example	:SOUR:RAD:ARB:DELeTe:ALL
Notes	<p>When in Sequence Analyzer mode and Include Source is Yes, an attempt to delete all files from ARB memory is rejected with an error.</p> <p>When Include Source is No and you attempt to delete all files from ARB memory when the ARB is currently playing a file, all files except the one playing are deleted and an error is generated.</p> <p>If you attempt to delete all files from ARB memory when there are waveform files used in "List Sequencer" on page 712 and "Sequencer" on page 713 state is ON, all files except the files currently being used in list sequencer are deleted, and an error is generated.</p> <p>If the ARB is ON and you load a file to ARB memory or delete a file from ARB memory, the playing waveform segment may not keep phase continuity during the ARB memory operation. The waveform will be replayed after the ARB operation is finished.</p>
Initial S/W Revision	A.05.00

Segments on Hard Disk

This key functions the same as ["Segments on Hard Disk" on page 738](#).

Key Path	Source, List Sequencer, List Sequencer Setup, Waveform
Initial S/W Revision	Prior to A.09.00

Load Segment To ARB Memory

This key functions the same as ["Load Segment To ARB Memory" on page 738](#).

Key Path	Source, List Sequencer, List Sequencer Setup, Waveform, Segment on Hard Drive
Initial S/W Revision	Prior to A.09.00

Load All To ARB Memory

This key functions the same as ["Load All To ARB Memory" on page 739](#).

Key Path	Source, List Sequencer, List Sequencer Setup, Waveform, Segment on Hard Drive
Initial S/W Revision	Prior to A.09.00

Change Directory ...

This key functions the same as ["Change Directory..." on page 740](#).

Key Path	Source, List Sequencer, List Sequencer Setup, Waveform, Segment on Hard Drive
Initial S/W Revision	Prior to A.09.00

Default Directory ...

This key functions the same as ["Default Directory..." on page 740](#)

Key Path	Source, List Sequencer, List Sequencer Setup, Waveform, Segment on Hard Drive
Initial S/W Revision	Prior to A.09.00

Segments in ARB Memory

This key functions the same as ["Segments in ARB Memory" on page 740](#).

Key Path	Source, List Sequencer, List Sequencer Setup, Waveform, Segments in ARB Memory
Initial S/W Revision	Prior to A.09.00

Delete Segment From ARB Memory

This key functions the same as "[Delete Segment From ARB Mem](#)" on page 741.

Key Path	Source, List Sequencer, List Sequencer Setup, Waveform, Segments in ARB Memory, Segment in ARB Memory
Initial S/W Revision	Prior to A.09.00

Delete All From ARB Memory

This key functions the same as "[Delete All From ARB Memory](#)" on page 741.

Key Path	Source, List Sequencer, List Sequencer Setup, Waveform, Segments in ARB Memory, Segment in ARB Memory
Initial S/W Revision	Prior to A.09.00

Step Duration

Allows access to the sub-menus for setting up the duration of play for the current step.

The duration can be set to be either the number of times for the ARB file associated with the sequence to play, or a specific time value, or continuous. If the step is set to play a CW tone, the step duration cannot be set to a play count.

Key Path	Source, List Sequencer, List Sequencer Setup
Remote Command	:SOURce:LIST:STEP[1] 2 3...1000:SETup:DURation:TYPE TIME COUNT CONTInuous CABort :SOURce:LIST:STEP[1] 2 3...1000:SETup:DURation:TYPE?
Example	:SOUR:LIST:STEP2:SET:DUR:TYPE TIME :SOUR:LIST:STEP2:SET:DUR:TYPE?
Notes	SCPI is supported after A.09.40
Notes	If "Step Duration" is set to "Time" or "Play Count" for the last step, the last step of ARB keeps playing as if set to "Continuous", until the set "Time" has expired or until the "Play Count" setting is reached. However, you can query Error! Reference source not found. Source Sweeping Condition Message to find out if the current list sequence is complete or not.
Range	Time Play Count Continuous Continuous Abort
Initial S/W Revision	A.05.00

Time

Sets the duration of the current step to be a time value for the length of time the step will play. Pressing this key again opens another menu which allows you to set the time value for the step duration.

Key Path	Source, List Sequencer, List Sequencer Setup, Step Duration
Example	:SOUR:LIST:STEP2:SET:DUR:TYPE TIME
Notes	SCPI is supported after A.09.40
Initial S/W Revision	A.05.00

Duration Time

Allows you to specify the length of time the current step will play.

When Step Duration is **Continuous Abort** this parameter specifies the maximum duration that the waveform will continue to play after a step trigger is received before the transition to the next waveform will occur. Duration is limited to a maximum of 20 seconds.

If the Transition Time value is longer than the Step Duration Time, an error is generated when initiating a source list sequence. For source list sequence, transition time is included in the step duration length (not occupy additional time). If the Transition Time value is longer than the Step Duration Time, the real step duration length is extended to equal the transition time and cause a timing shift. This check is also described in section **Error! Reference source not found.** List Sequence Step Validation.

Key Path	Source, List Sequencer, List Sequencer Setup, Step Duration, Time
Remote Command	:SOURce:LIST:STEP[1] 2 3...1000:SETup:DURation:TCOUNT <double> :SOURce:LIST:STEP[1] 2 3...1000:SETup:DURation:TCOUNT?
Example	:SOUR:LIST:STEP2:SET:DUR:TCO 1s :SOUR:LIST:STEP2:SET:DUR:TCO?
Notes	SCPI is supported after A.09.40 This SCPI is reused by "Play Count", "Duration Time" and "Continuous Abort" according to current Duration Type setting is "Play Count" or "Duration Time" or "Continuous Abort". If current "Duration Type" is "Continuous", then popup error -221, "Settings conflict; Cannot accept time or count input when step duration type is Continuous on step #"
Notes	If "Duration Time" is set for the last step, the last step of ARB keeps playing as if set to "Continuous" after set time expires. However, you can query Source Sweeping Condition Message (:STAT:OPER:COND?) to find out if the current list sequence is complete or not.
Preset	1.00 ms
Min	100 μ s
Max	1800 s
Initial S/W Revision	A.05.00

Play Count

Sets the duration of the current step to be an integer value for the number of times (play count) the ARB file is selected for playback during this step. For example, a 5 second ARB will be set to play 5 times during the step.

Key Path	Source, List Sequencer, List Sequencer Setup, Step Duration
Example	:SOUR:LIST:STEP2:SET:DUR:TYPE COUN
Notes	SCPI is supported after A.09.40 This key is unavailable and is grayed out if the current step is configured to CW tone rather than an ARB waveform.
Initial S/W Revision	A.05.00

Header Utilities

Allows access to the header utilities sub-menu. Pressing this key also causes the central display area to change to display the File Header Information view.

Key Path	Source, Modulation Setup, ARB
Dependencies	This key is only available if there is currently a waveform selected for playback. If no waveform is selected, the key is grayed out.
Initial S/W Revision	A.05.00

Continuous

Sets the current step to be played continuously until the next step starts. The waveform will always play completely before transitioning to the next step.

Key Path	Source, List Sequencer, List Sequencer Setup, Step Duration
Example	:SOUR:LIST:STEP2:SET:DUR:TYPE CONT
Notes	SCPI is supported after A.09.40
Initial S/W Revision	A.05.00

Output Trigger

Allows you to specify the trigger output for the current step. The trigger output signal is sent at the start of the step.

When select "On", trigger event will occur on both Internal and External2 paths. Select "Off" will turn off trigger output.

Key Path	Source, List Sequencer, List Sequencer Setup
Remote Command	:SOURce:LIST:STEP[1] 2 3...1000:SETup:OUTPut:TRIGger ON OFF 1 0 :SOURce:LIST:STEP[1] 2 3...1000:SETup:OUTPut:TRIGger
Example	:SOUR:LIST:STEP2:SET:OUTP:TRIG ON :SOUR:LIST:STEP2:SET:OUTP:TRIG?
Notes	SCPI is supported after A.09.40
Preset	Off

Range	On Off
Initial S/W Revision	A.05.00

Step Configuration (Remote Command Only)

This SCPI command is used to configure the List Sequencer and is detailed in the table below. The command is defined such that you send one command per step, with the step number being specified as a subopcode of the SCPI command. Each command includes all the parameter settings for the step. As a step is setup, the values entered are run through several levels of validation.

Remote Command	<pre>:SOURce:LIST:STEP[1] 2 ... 4..1000:SETup IMMEDIATE INTernal KEY BUS EXTernal2, <time>, NONE PGSM EGSM RGSM DCS1800 PCS1900 TGSM810 GSM450 GSM480 GSM700 GSM850 BANDI BANDII BANDIII BANDIV BANDV BANDVI BANDVII BANDVIII BANDIX BANDX BANDXI BANDXII BANDXIII BANDXIV BANDXIX USCELL USPCS JAPAN KOREAN NMT IMT2K UPPER SECOND PAMR400 PAMR800 IMTEXT PCS1DOT9G AWS US2DOT5G PUBLIC LOWER NONE BAND1 BAND2 BAND3 BAND4 BAND5 BAND6 BAND7 BAND8 BAND10 BAND11 BAND12 BAND13 BAND14 BAND17 BAND18 BAND19 BAND20 BAND21 BAND24 BAND25 BAND26 BAND33 BAND34 BAND35 BAND36 BAND37 BAND38 BAND39 BAND40 BAND41 BAND42 BAND43 BANDA BANDB BANDC BANDD BANDE BANDF, DOWN UP, <freq>, <ampl>, <string>, TIME COUNT CONTinuous, <time>, ON OFF 1 0, [<int>], :SOURce:LIST:STEP[1] 2 ... 4..1000:SETup?</pre>
Example	:SOUR:LIST:STEP1:SET INT, 1ms, PGSM, DOWN, 10, -25 dBm, "GSM_Test1.bin", TIME, 10ms, OFF, 255
Notes	<p>The parameters are:</p> <p>(There is a total of 11 items in each step, the following is a list of the items in the order they must appear in the remote command.)</p> <ol style="list-style-type: none"> 1. Step Trigger <enum> – specifies the input trigger for the step. For details of the valid types of step trigger see "Step Trigger" on page 715. 2. Transition Time <time> – specifies the transition time for the step in seconds. For details of the valid ranges for the transition time see "Transition Time" on page 717. 3. Radio Band <enum> – specifies the radio band for the step. For details of the valid radio bands see "Radio Setup" on page 718. 4. Radio Band Link <enum> – specifies the radio band link direction for the step. For details of the valid link types, see "Radio Band Link" on page 734. 5. Frequency/Channel Number <freq>/<chan num> – specifies the frequency in Hz or the channel number for the step. The channel number and frequency are combined as one parameter that represents the frequency or channel number depending on the radio band setting. If the radio band is set to NONE, this value is interpreted as a frequency value in Hz. If the radio band is set to a valid band, this value is interpreted as a channel number. For details of the valid ranges for frequency and channel numbers, see "Channel" on page 735 and "Frequency" on page 735. 6. Power <ampl> – specifies the output power for the step in dBm. For details of the valid ranges see "Power" on page 736. 7. Waveform <string> – specifies the waveform for playback during the step. The step can output either a new ARB waveform, continue playback of the previous waveform, or output a CW tone. The

options for specifying these are:

<filename> - plays the specified waveform from the start. The filename value is the name of the file within ARB playback memory, it does not include the windows path to the file on the HDD. If you enter a filename for a waveform that does not reside within ARB playback memory, an error is generated.

CONT - continues playback of the ARB file from the previous step

CW - outputs a CW tone

OFF - disable RF output

8. Step Duration <enum> - specifies the duration of the step. The duration can be specified to be either time, or play count of the ARB file associated with the step, or continuous. If Waveform is set to "CW", this value cannot be set to Play Count and an error will be generated. If continuous is selected, the following Time or Count value is ignored. For further details of this setting, see "[Step Duration](#)" on page 743.

9. Time or Count <time/int> - specifies time duration in seconds or play count of the ARB file associated with the step. For further details of this setting, including the valid ranges for the time or play count setting, "[Time](#)" on page 743 and "[Play Count](#)" on page 744.

10. Output Trigger <Boolean> - specifies the output trigger for the step. For details of the ranges for this setting see "[Output Trigger](#)" on page 745.

Dependencies	The range of subopcode values is 1 to 1000 and the value you enter is determined by the number of steps you have configured. For details see " Number of Steps " on page 714. If you attempt to remotely set or query a subopcode that is out of range, an error is generated.
Initial S/W Revision	A.05.00

Step Configuration of Step Trigger parameter list (Remote Command Only)

This SCPI command is to configure "Step Trigger" parameter array of the whole List Sequencer at one time. The number of array is same as step number defined in "[Number of Steps](#)" on page 714 Number of Steps. As a step is setup, the value entered run through several levels of validation.

Remote Command	:SOURce:LIST:SETup:INPut:TRIGger <enum>, <enum>, <enum>, ... :SOURce:LIST:SETup:INPut:TRIGger?
Example	:SOUR:LIST:SET:INP:TRIG IMM,INT,EXT2 :SOUR:LIST:SET:INP:TRIG?
Notes	The command is to setup below parameter array of whole list sequence. Step Trigger <enum> - specifies the input trigger for the step. For details of the valid types of step trigger see " Step Trigger " on page 715. If input parameter number exceeds the step number defined by " Number of Steps " on page 714 Number of Steps then generate error ", and only those parametes whose index number falls in number of steps will be updated.
Remote Command Notes	IMMEDIATE INTERNAL KEY BUS EXTERNAL2
Dependencies	The range is 1 to 1000 which is determined by the number of steps you have configured. For details see " Number of Steps " on page 714.
Initial S/W Revision	A.09.40

Step Configuration of Transition Time parameter list (Remote Command Only)

This SCPI command is to configure “Transition Time” parameter array of the whole List Sequencer at one time. The number of array is same as step number defined in ["Number of Steps" on page 714](#) Number of Steps. As a step is setup, the value entered run through several levels of validation.

Remote Command	:SOURce:LIST:SETup:TRANsition:TIME <time>, <time>, <time>, ... :SOURce:LIST:SETup:TRANsition:TIME?
Example	:SOUR:LIST:SET:TRAN:TIME 1ms,1ms,1ms :SOUR:LIST:SET:TRAN:TIME?
Notes	The command is to setup below parameter array of whole list sequence. Transition Time <time> – specifies the transition time for the step in seconds. For details of the valid ranges for the transition time see "Transition Time" on page 717 If input parameter number exceeds the step number defined by "Number of Steps" on page 714 Number of Steps then generate error ", and only those parametes whose index number falls in number of steps will be updated.
Dependencies	The range is 1 to 1000 which is determined by the number of steps you have configured. For details see "Number of Steps" on page 714 .
Initial S/W Revision	A.09.40

Step Configuration of Radio Band parameter list (Remote Command Only)

This SCPI command is to configure “Radio Band” parameter array of the whole List Sequencer at one time. The number of array is same as step number defined in ["Number of Steps" on page 714](#) Number of Steps. As a step is setup, the value entered run through several levels of validation.

R e m o t e C o m m a n d	:SOURce:LIST:SETup:RADio:BAND <enum>, <enum>, <enum>, ... :SOURce:LIST:SETup:RADio:BAND?
E x a m p l	:SOUR:LIST:SET:RAD:BAND PGSM, EGSM, RGSM :SOUR:LIST:SET:RAD:BAND?

e	
N	The command is to setup below parameter array of whole list sequence.
O	Radio Band <enum> – specifies the radio band for the step. For details of the valid radio bands see "Radio Setup" on page 718 .
T	If input parameter number exceeds the step number defined by "Number of Steps" on page 714 Number of Steps then generate error ", and only those parametes whose index number falls in number of steps will be updated.
R	NONE PGSM EGSM RGSM DCS1800 PCS1900 TGSM810 GSM450 GSM480 GSM700 GSM850 BANDI BANDII BANDIII BANDIV BANDV BANDVI BANDVII BANDVIII BANDIX BANDX BANDXI BANDXII BANDXIII BANDXIV BANDXIX USCELL USPCS JAPAN KOREAN NMT IMT2K UPPER SECOND PAMR400 PAMR800 IMTEXT PCS1DOT9G AWS US2DOT5G PUBLIC LOWER NONE BAND1 BAND2 BAND3 BAND4 BAND5 BAND6 BAND7 BAND8 BAND10 BAND11 BAND12 BAND13 BAND14 BAND17 BAND18 BAND19 BAND20 BAND21 BAND24 BAND25 BAND26 BAND33 BAND34 BAND35 BAND36 BAND37 BAND38 BAND39 BAND40 BAND41 BAND42 BAND43 BANDA BANDB BANDC BANDD BANDE BANDF
C o m m a n d	
N o t e s	
D	The range is 1 to 1000 which is determined by the number of steps you have configured. For details see "Number of Steps" on page 714 .
p e n d e n c i e s	
I	A.09.40
n i t i a l	
S / W	

R
e
v
i
s
i
o
n

Step Configuration of Radio Band Link parameter list (Remote Command Only)

This SCPI command is to configure “Radio Band Link” parameter array of the whole List Sequencer at one time. The number of array is same as step number defined in ["Number of Steps" on page 714](#) Number of Steps. As a step is setup, the value entered run through several levels of validation.

Remote Command	:SOURce:LIST:SETup:RADio:BAND:LINK <enum>, <enum>, <enum>, ... :SOURce:LIST:SETup:RADio:BAND:LINK?
Example	:SOUR:LIST:SET:RAD:BAND:LINK DOWN,UP,UP :SOUR:LIST:SET:RAD:BAND:LINK?
Notes	The command is to setup below parameter array of whole list sequence. Radio Band Link <enum> – specifies the radio band link direction for the step. For details of the valid link types, see "Radio Band Link" on page 734 . If input parameter number exceeds the step number defined by "Number of Steps" on page 714 Number of Steps then generate error ", and only those parametes whose index number falls in number of steps will be updated.
Remote Command Notes	DOWN UP
Dependencies	The range is 1 to 1000 which is determined by the number of steps you have configured. For details see "Number of Steps" on page 714 .
Initial S/W Revision	A.09.40

Step Configuration of Frequency/Channel Number parameter list (Remote Command Only)

This SCPI command is to configure “Frequency” or “Channel Number” parameter array of the whole List Sequencer at one time. The number of array is same as step number defined in ["Number of Steps" on page 714](#) Number of Steps. As a step is setup, the value entered run through several levels of validation.

Remote Command	:SOURce:LIST:SETup:CNFRrequency <double>, <double>, <double>, ... :SOURce:LIST:SETup:CNFRrequency?
Example	:SOUR:LIST:SET:CNFR 1GHz,100MHz,100MHz :SOUR:LIST:SET:CNFR? SOUR:LIST:SET:CNFR 124,124,124 :SOUR:LIST:SET:CNFR?

Notes	<p>The command is to setup below parameter array of whole list sequence.</p> <p>Frequency/Channel Number <freq>/<chan num> – specifies the frequency in Hz or the channel number for the step. The channel number and frequency are combined as one parameter that represents the frequency or channel number depending on the radio band setting. If the radio band is set to NONE, this value is interpreted as a frequency value in Hz. If the radio band is set to a valid band, this value is interpreted as a channel number. For details of the valid ranges for frequency and channel numbers, see "Channel" on page 735 and "Frequency" on page 735</p> <p>This SCPI is used to setup/query channel number or frequency setting, according to current Radio Band setting of that step. If Radio Band is “NONE”, then it’s frequency. If Radio Band is not “NONE”, then it’s channel number</p> <p>If input parameter number exceeds the step number defined by "Number of Steps" on page 714 Number of Steps then generate error ", and only those parametes whose index number falls in legal step number will be updated.</p>
Dependencies	<p>The range is 1 to 1000 which is determined by the number of steps you have configured. For details see "Number of Steps" on page 714.</p>
Initial S/W Revision	A.09.40

Step Configuration of Power parameter list (Remote Command Only)

This SCPI command is to configure “Power” parameter array of the whole List Sequencer at one time. The number of array is same as step number defined in ["Number of Steps" on page 714](#) Number of Steps. As a step is setup, the value entered run through several levels of validation.

Remote Command	<pre>:SOURce:LIST:SETup:AMPLitude <ampl>, <ampl>, <ampl>, ... :SOURce:LIST:SETup:AMPLitude?</pre>
Example	<pre>:SOUR:LIST:SET:AMPL -50dBm,-40dBm,-30dBm :SOUR:LIST:SET:AMPL?</pre>
Notes	<p>The command is to setup below parameter array of whole list sequence.</p> <p>Power <ampl> – specifies the output power for the step in dBm. For details of the valid ranges see "Power" on page 736.</p> <p>If input parameter number exceeds the step number defined by "Number of Steps" on page 714 Number of Steps then generate error ", and only those parametes whose index number falls in legal step number will be updated.</p>
Dependencies	<p>The range is 1 to 1000 which is determined by the number of steps you have configured. For details see "Number of Steps" on page 714.</p>
Initial S/W Revision	A.09.40

Step Configuration of Waveform parameter list (Remote Command Only)

This SCPI command is to configure “Waveform” parameter array of the whole List Sequencer at one time. The number of array is same as step number defined in ["Number of Steps" on page 714](#) Number of Steps. As a step is setup, the value entered run through several levels of validation.

Remote Command	<pre>:SOURce:LIST:SETup:WAVEform <string>, <string>, <string>, ...</pre>
-----------------------	--

	:SOURce:LIST:SETup:WAVeform?
Example	:SOUR:LIST:SET:WAV "CW","Off","CONT" :SOUR:LIST:SET:WAV?
Notes	<p>The command is to setup below parameter array of whole list sequence.</p> <p>Waveform <string> - specifies the waveform for playback during the step. The step can output either a new ARB waveform, continue playback of the previous waveform, or output a CW tone. The options for specifying these are:</p> <p><filename> - plays the specified waveform from the start. The filename value is the name of the file within ARB playback memory, it does not include the windows path to the file on the HDD. If you enter a filename for a waveform that does not reside within ARB playback memory, an error is generated.</p> <p>CONT - continues playback of the ARB file from the previous step</p> <p>CW - outputs a CW tone</p> <p>OFF - disable RF output</p> <p>If input parameter number exceeds the step number defined by "Number of Steps" on page 714 Number of Steps then generate error ", and only those parameters whose index number falls in number of steps will be updated.</p>
Dependencies	The range is 1 to 1000 which is determined by the number of steps you have configured. For details see "Number of Steps" on page 714.
Range	"filename" "CW" "Off" "CONT"
Initial S/W Revision	A.09.40

Step Configuration of Step Duration parameter list (Remote Command Only)

This SCPI command is to configure "Step Duration" parameter array of the whole List Sequencer at one time. The number of array is same as step number defined in "Number of Steps" on page 714 Number of Steps. As a step is setup, the value entered run through several levels of validation.

Remote Command	:SOURce:LIST:SETup:DURation:TYPE <enum>, <enum>, <enum>, ... :SOURce:LIST:SETup:DURation:TYPE?
Example	:SOUR:LIST:SET:DUR:TYPE COUN,TIME,CONT :SOUR:LIST:SET:DUR:TYPE?
Notes	<p>The command is to setup below parameter array of whole list sequence.</p> <p>Step Duration <enum> - specifies the duration of the step. The duration can be specified to be either time, or play count of the ARB file associated with the step, or continuous. If Waveform is set to "CW", this value cannot be set to Play Count and an error will be generated. If continuous is selected, the following Time or Count value is ignored. For further details of this setting, see "Step Duration" on page 743.</p> <p>If input parameter number exceeds the step number defined by "Number of Steps" on page 714 Number of Steps then generate error ", and only those parameters whose index number falls in number of steps will be updated.</p>
Remote Command Notes	TIME COUNT CONTinuous
Dependencies	The range is 1 to 1000 which is determined by the number of steps you have configured. For details

	see "Number of Steps" on page 714.
Initial S/W Revision	A.09.40

Step Configuration of Duration Time or Play Count parameter list (Remote Command Only)

This SCPI command is to configure “Duration Time” or “Play Count” parameter array of the whole List Sequencer at one time. The number of array is same as step number defined in ["Number of Steps" on page 714](#) Number of Steps. As a step is setup, the value entered run through several levels of validation.

Remote Command	:SOURce:LIST:SETup:TOCount <time/int>, <time/int>, <time/int>, ... :SOURce:LIST:SETup:TOCount?
Example	:SOUR:LIST:SET:TOC 1s,2s,3s :SOUR:LIST:SET:TOC? :SOUR:LIST:SET:TOC 5,6,7 :SOUR:LIST:SET:TOC?
Notes	The command is to setup below parameter array of whole list sequence. Time or Count <time/int> – specifies time duration in seconds or play count of the ARB file associated with the step. For further details of this setting, including the valid ranges for the time or play count setting, "Time" on page 743 and "Play Count" on page 744 . If input parameter number exceeds the step number defined by "Number of Steps" on page 714 Number of Steps then generate error ", and only those parametes whose index number falls in number of steps will be updated. If current "Step Duration" on page 743 is “Continuous”, then generate error -221, "Settings conflict;Cannot accept time or count input when step duration type is Continuous on step #"
Dependencies	The range is 1 to 1000 which is determined by the number of steps you have configured. For details see "Number of Steps" on page 714.
Initial S/W Revision	A.09.40

Step Configuration of Output Trigger parameter list (Remote Command Only)

This SCPI command is to configure “Output Trigger” parameter array of the whole List Sequencer at one time. The number of array is same as step number defined in ["Number of Steps" on page 714](#) Number of Steps. As a step is setup, the value entered run through several levels of validation.

Remote Command	:SOURce:LIST:SETup:OUTPut:TRIGger <bool>, <bool>, <bool>, ... :SOURce:LIST:SETup:OUTPut:TRIGger ?
Example	:SOUR:LIST:SET:OUTP:TRIG ON,OFF,ON :SOUR:LIST:SET:OUTP:TRIG?
Notes	The command is to setup below parameter array of whole list sequence. Output Trigger <Boolean> – specifies the output trigger for the step. For details of the ranges for this setting see "Output Trigger" on page 745 . If input parameter number exceeds the step number defined by "Number of Steps" on page 714 Number of Steps then generate error ", and only those parametes whose index number falls in

	legal step number will be updated.
Remote Command Notes	ON OFF 1 0
Dependencies	The range is 1 to 1000 which is determined by the number of steps you have configured. For details see " Number of Steps " on page 714.
Initial S/W Revision	A.09.40

Clear List (Remote Command Only)

This command is the SCPI equivalent of the Clear List UI feature described in.

Remote Command	:SOURce:LIST:SETup:CLEar
Example	:SOUR:LIST:SETup:CLE
Initial S/W Revision	A.05.00

Trigger Type

Allows access to the sub-menu for selecting the output trigger type for the list sequencer globally. It cannot be changed between different sequence steps.

Key Path	Source, List Sequencer
Remote Command	:SOURce:LIST:TRIGgerout:TYPe BEGinningofstep DATamarker
Example	:SOUR:LIST:TRIG:TYP BEG :SOUR:LIST:TRIG:TYP?
Notes	SCPI is supported after A.14.00 This an alias SCPI of :SOURce:LIST:TRIGger:OUTPut:TYPe STEP MARKer Recommend to use : SOURce:LIST:TRIGger:OUTPut:TYPe STEP MARKer
Preset	BEGinningofstep
Range	BEGinningofstep DATamarker
Initial S/W Revision	A.14.00

BeginningOfStep

Sets the output trigger type as BeginningOfStep for the whole source sequence.

Key Path	Source, List Sequencer, Trigger Type
Example	:SOUR:LIST:TRIG:TYP BEG
Notes	SCPI is supported after A.14.00 This an alias SCPI of :SOURce:LIST:TRIGger:OUTPut:TYPe STEP Recommend to use : SOURce:LIST:TRIGger:OUTPut:TYPe STEP

Initial S/W Revision	A.14.00
----------------------	---------

DataMarker

Sets the output trigger type as DataMarker for the whole source sequence. When DataMarker is selected, which marker to route is also needed to be set.

Key Path	Source, List Sequencer, Trigger Type
Example	:SOUR:LIST:TRIG:TYP DAT
Notes	SCPI is supported after A.14.00 This an alias SCPI of :SOURce:LIST:TRIGger:OUTPut:TYPE MARKer Recommend to use : SOURce:LIST:TRIGger:OUTPut:TYPE MARKer

Initial S/W Revision	A.14.00
----------------------	---------

Marker 1

Sets the output trigger maker routing to Marker 1 for DataMarker in the whole source sequence.

Key Path	Source, List Sequencer, Trigger Type, DataMarker
Example	:SOUR:LIST:TRIG:TYPE:MARK M1
Notes	SCPI is supported after A.14.00 This an alias SCPI of :SOURce:LIST:TRIGger:OUTPut:TYPE:MARKer M1 Recommend to use :SOURce:LIST:TRIGger:OUTPut:TYPE:MARKer M1

Initial S/W Revision	A.14.00
----------------------	---------

Marker 2

Sets the output trigger maker routing to Marker 2 for DataMarker in the whole source sequence.

Key Path	Source, List Sequencer, Trigger Type, DataMarker
Example	:SOUR:LIST:TRIG:TYPE:MARK M2
Notes	SCPI is supported after A.14.00 This an alias SCPI of :SOURce:LIST:TRIGger:OUTPut:TYPE:MARKer M2 Recommend to use :SOURce:LIST:TRIGger:OUTPut:TYPE:MARKer M2

Initial S/W Revision	A.14.00
----------------------	---------

Marker 3

Sets the output trigger maker routing to Marker 3 for DataMarker in the whole source sequence.

Key Path	Source, List Sequencer, Trigger Type, DataMarker
Example	:SOUR:LIST:TRIG:TYPE:MARK M3
Notes	SCPI is supported after A.14.00 This an alias SCPI of :SOURce:LIST:TRIGger:OUTPut:TYPE:MARKer M3 Recommend to use :SOURce:LIST:TRIGger:OUTPut:TYPE:MARKer M3
Initial S/W Revision	A.14.00

Marker 4

Sets the output trigger maker routing to Marker 4 for DataMarker in the whole source sequence.

Key Path	Source, List Sequencer, Trigger Type, DataMarker
Example	:SOUR:LIST:TRIG:TYPE:MARK M4
Notes	SCPI is supported after A.14.00 This an alias SCPI of :SOURce:LIST:TRIGger:OUTPut:TYPE:MARKer M4 Recommend to use :SOURce:LIST:TRIGger:OUTPut:TYPE:MARKer M4
Initial S/W Revision	A.14.00

Manual Trigger Now

Pressing this key provides a software trigger event to the list sequencer. During execution of sequence, if the sequencer is halted on any step that has been configured with a “Manual” step trigger, then this key press will cause the sequencer to continue and execute the step.

Key Path	Source, List Sequencer
Remote Command	No remote command, front panel only.
Initial S/W Revision	A.05.00

Remote Software Trigger (Remote command Only)

During execution of a list sequence, the sequence will halt and wait at any step that has Step Trigger set to “Bus”. Sending this command will trigger the step and continue the sequence.

Remote Command	:SOURce:LIST:TRIGger:INITiate[:IMMediate]
Example	:SOUR:LIST:TRIG:INIT
Initial S/W Revision	A.05.00

Query List Sequence Initiation Armed Status (Remote Command Only)

This is a blocking SCPI query to determine if source list sequence being initiated successfully or not.

Remote Command	:SOURce:LIST:INITiation:ARMed?
Example	:SOUR:LIST:INIT:ARMed?
Notes	The return data is in the following format: Integer
Notes	Query only SCPI. Returning "1" if list sequence has been initiated successfully, returning "0" if not. Once get "0", you can use :SYST:ERR? to query what error happened. Just like "*OPC?", this command can be blocked until event/status "IsSourceSweeping" happens, and then returns. Doing so can help user's script query armed status only once during the time interval of the initiation. As an ancillary SCPI of existing SCPI ":SOUR:LIST:TRIGger[:IMMediate]" (see "Initiate Sequence" on page 713 Initiate Sequence), the right usage of this command is to use it after ":SOUR:LIST:TRIG". If not, this command will return "1" immediately.
Notes	There is an alias SCPI ":SOURce:LIST:TRIGger:INITiation:ARMed?".
Initial S/W Revision	A.09.40

Source Preset

Allows you to preset the source settings to their default values.

Key Path	Source
Remote Command	:SOURce:PRESet
Example	:SOUR:PRES

Span X Scale

Accesses the frequency span menu when the spectrum view is active or the horizontal time menu when the waveform view is active.

Key Path	Front-panel key
Initial S/W Revision	Prior to A.02.00

Span (Spectrum View)

This parameter allows you to modify the frequency span in spectrum view for the complex spectrum measurement. This is translated to the required Digital IF bandwidth for the FFT analysis. The analyzer's Digital IF bandwidth is always equal to or greater than this value. The maximum span is dependent upon the instrument type and the options that are installed. The maximum span is equal to the maximum bandwidths of the IF Paths.

Key Path	SPAN X Scale
Mode	BASIC
Remote Command	<code>[:SENSe] :SPEctrum:FREQuency:SPAN <freq></code> <code>[:SENSe] :SPEctrum:FREQuency:SPAN?</code>
Example	SPEC:FREQ:SPAN 10 SPEC:FREQ:SPAN?
Notes	You must be in the IQ Analyzer (Basic) mode to use this command. Use INSTRUMENT:SElect to set the mode.
Couplings	Changing the span causes the resolution bandwidth to change automatically, and affects data acquisition time.
Preset	8 MHz
State Saved	Saved in instrument state.
Min	10 Hz
Max	Hardware Dependent: RF Input: No Option = 8.0 MHz Option B25 = 25.0 MHz Option B40 = 40.0 MHz Option B85 = 85.0 MHz Option B1A = 125.0 MHz Option B1X = 140.0 MHz Option B1Y = 160.0 MHz
Initial S/W Revision	Prior to A.02.00

Sweep/Control

Accesses a menu that enables you to configure the Sweep and Control functions of the analyzer, such as Acquisition Time and Gating.

Key Path	Front-panel key
Initial S/W Revision	Prior to A.02.00

Pause/Resume

Pauses a measurement after the current data acquisition is complete.

When Paused, the label on the key changes to Resume. Pressing Resume un-pauses the measurement. When you are Paused, pressing **Restart**, **Single** or **Cont** does a Resume.

Key Path	Sweep/Control
Remote Command	:INITiate:PAUSE
Dependencies	Grayed out in Measurements that do not support Pausing. Blanked in Modes that do not support Pausing.
Initial S/W Revision	Prior to A.02.00

Key Path	Sweep/Control
Remote Command	:INITiate:RESume
Dependencies	Grayed out in Measurements that do not support Pausing. Blanked in Modes that do not support Pausing.
Initial S/W Revision	Prior to A.02.00

Abort (Remote Command Only)

This command is used to stop the current measurement. It aborts the current measurement as quickly as possible, resets the sweep and trigger systems, and puts the measurement into an "idle" state. If the analyzer is in the process of aligning when ABORT is sent, the alignment finishes before the abort function is performed. So ABORT does not abort an alignment.

If the analyzer is set for Continuous measurement, it sets up the measurement and initiates a new data measurement sequence with a new data acquisition (sweep) taken once the trigger condition is met.

If the analyzer is set for Single measurement, it remains in the "idle" state until an :INIT:IMM command is received.

Remote Command	:ABORT
Example	:ABOR

Notes	<p>If :INITiate:CONTinuous is ON, then a new continuous measurement will start immediately; with sweep (data acquisition) occurring once the trigger condition has been met.</p> <p>If :INITiate:CONTinuous is OFF, then :INITiate:IMMediate is used to start a single measurement; with sweep (data acquisition) occurring once the trigger condition has been met.</p>
Dependencies	<p>For continuous measurement, ABORt is equivalent to the Restart key.</p> <p>Not all measurements support the abort command.</p>
Status Bits/OPC dependencies	<p>The STATus:OPERation register bits 0 through 8 are cleared.</p> <p>The STATus:QUEStionable register bit 9 (INTEgrity sum) is cleared.</p> <p>Since all the bits that feed into OPC are cleared by the ABORt, the ABORt will cause the *OPC query to return true.</p>
Initial S/W Revision	Prior to A.02.00

System

See ["System" on page 166](#)

Trace/Detector

Toggles the instantaneous trace display between On and Off.

This is a display only feature and the actual Spectrum trace still exists even when the Spectrum Trace State is OFF. It is just invisible. Hence it is possible to set Spectrum Trace State to OFF and put a marker on Spectrum trace.

Key Path	Front-panel key
Remote Command	:TRACe:SPECTrum:STRace[:STATE] OFF ON 0 1 :TRACe:SPECTrum:STRace[:STATE]?
Example	TRAC:SPEC:STR OFF TRAC:SPEC:STR?
Preset	ON
State Saved	Saved in instrument state.
Range	On Off
Initial S/W Revision	Prior to A.09.00

Trigger

See ["Trigger" on page 220](#)

Free Run

See ["Free Run " on page 227](#)

Video

See ["Video \(IF Envelope\) " on page 228](#)

Trigger Level

See ["Trigger Level " on page 228](#)

Trig Slope

See ["Trig Slope " on page 229](#)

Trig Delay

See ["Trig Delay " on page 230](#)

External 1

See ["External 1 " on page 246](#)

Trigger Level

See ["Trigger Level " on page 247](#)

Trig Slope

See ["Trig Slope " on page 247](#)

Trig Delay

See ["Trig Delay " on page 233](#)

Zero Span Delay Comp

See ["Zero Span Delay Comp On/Off" on page 234](#)

External 2

See ["External 2 " on page 248](#)

Trigger Level

See ["Trigger Level " on page 248](#)

Trig Slope

See ["Trig Slope " on page 249](#)

Trig Delay

See ["Trig Delay "](#) on page 236

Zero Span Delay Comp

See ["Zero Span Delay Comp On/Off"](#) on page 236

RF Burst

See ["RF Burst "](#) on page 249

Absolute Trigger

See ["Absolute Trigger Level"](#) on page 250

Relative Trigger

See ["Relative Trigger Level"](#) on page 239

Trig Slope

See ["Trigger Slope "](#) on page 251

Trig Delay

See ["Trig Delay "](#) on page 240

Periodic Timer

See ["Periodic Timer \(Frame Trigger\) "](#) on page 241

Period

See ["Period "](#) on page 242

Offset

See ["Offset "](#) on page 243

Offset Adjust (Remote Command Only)

See ["Offset Adjust \(Remote Command Only\)"](#) on page 244

Reset Offset Display

See ["Reset Offset Display "](#) on page 245

Sync Source

See ["Sync Source "](#) on page 245

Off

See ["Off "](#) on page 246

External 1

See "External 1 " on page 246

Trigger Level

See "Trigger Level " on page 247

Trig Slope

See "Trig Slope " on page 247

External 2

See "External 2 " on page 248

Trigger Level

See "Trigger Level " on page 248

Trig Slope

See "Trig Slope " on page 249

RF Burst

See "RF Burst " on page 249

Absolute Trigger

See "Absolute Trigger Level" on page 250

Trig Slope

See "Trigger Slope " on page 251

Trig Delay

See "Trig Delay" on page 251

Auto/Holdoff

See "Auto/Holdoff " on page 252

Auto Trig

See "Auto Trig " on page 252

Trig Holdoff

See "Trig Holdoff " on page 253

Holdoff Type

See "Holdoff Type" on page 253

User Preset

Accesses a menu that gives you the following three choices:

- **User Preset** – recalls a state previously saved using the Save User Preset function.
- **User Preset All Modes** – presets all of the modes in the analyzer
- **Save User Preset**– saves the current state for the current mode

Key Path	Front-panel key
Backwards Compatibility Notes	<p>User Preset is actually loading a state, and in legacy analyzers, it was possible to load a state without affecting the trace data, limit lines or correction data. Similarly it was possible to do a User Preset without affecting the trace data, limit lines or correction data.</p> <p>In the X-Series, “state” always includes all of this data; so whenever state is loaded, or User Preset is executed, all of the traces, limit lines and corrections are affected. Although this differs from previous behavior, it is desirable behavior, and should not cause adverse issues for users.</p> <p>On ESA and PSA, User Preset affected the entire instrument’s state. In the X-Series, User Preset only recalls the state for the active mode. There is a User Preset file for each mode. User Preset can never cause a mode switch as it can in legacy analyzers. If you want to recall all modes to their user preset file state, you will need to do a User Preset after mode switching into each mode.</p> <p>User Preset recalls mode state which can now include data like traces; whereas on ESA and PSA, User Preset did not affect data.</p>
Initial S/W Revision	Prior to A.02.00

User Preset

User Preset sets the state of the currently active mode back to the state that was previously saved for this mode using the Save User Preset menu key or the SCPI command, `SYST:PRES:USER:SAV`. It not only recalls the Mode Preset settings, but it also recalls all of the mode persistent settings, and the Input/Output system setting that existed at the time Save User Preset was executed.

If a Save User Preset has not been done at any time, User Preset recalls the default user preset file for the currently active mode. The default user preset files are created if, at power-on, a mode detects there is no user preset file. There will never be a scenario when there is no user preset file to restore. For each mode, the default user preset state is the same state that would be saved if a Save User Preset is performed in each mode right after doing a Restore Mode Default and after a Restore Input/Output Defaults.

The User Preset function does the following:

- Aborts the currently running measurement.
- Sets the mode State to the values defined by Save User Preset.
- Makes the saved measurement for the currently running mode the active measurement.
- Brings up the saved menu for the power-on mode.
- Clears the input and output buffers.
- Sets the Status Byte to 0.

Key Path	User Preset
Remote Command	:SYSTem:PRESet:USER
Example	:SYST:PRES:USER:SAVE:SYST:PRES:USER
Notes	:SYST:PRES:USER:SAVE is used to save the current state as the user preset state. Clears all pending OPC bits. The Status Byte is set to 0. Pressing the User Preset front-panel key while already in the User Preset menu will cause the User Preset to get executed
Couplings	A user preset will cause the currently running measurement to be aborted and cause the saved measurement to be active. Recalling a User Preset file has the same issues that recalling a Save State file has. Some settings may need to be limited and therefore re-coupled, since the capabilities of the mode may have changes when the User Preset file was last saved.
Initial S/W Revision	Prior to A.02.00

User Preset All Modes

Recalls all of the User Preset files for each mode, switches to the power-on mode, and activates the saved measurement from the power-on mode User Preset file.

NOTE

When the instrument is secured, all of the user preset files are converted back to their default user preset files.

The User Preset function does the following:

- Aborts the currently running measurement.
- Switches the Mode to the power-on mode.
- Restores the User Preset files for each mode.
- Makes the saved measurement for the power-on mode the active measurement.
- Brings up the saved menu for the power-on mode.
- Clears the input and output buffers.
- Sets the Status Byte to 0.

Key Path	User Preset
Remote Command	:SYSTem:PRESet:USER:ALL
Example	:SYST:PRES:USER:SAVE:SYST:PRES:USER:ALL
Notes	Clears all pending OPC bits. The Status Byte is set to 0. :SYST:PRES:USER:SAVE is used to save the current state as the user preset state.
Couplings	A user preset will cause the currently running measurement to be aborted, cause a mode switch to the power-on mode, and cause the saved measurement to be active in the power-on mode. Recalling a User Preset file has the same issues that recalling a Save State file has. Some settings may need to be limited and therefore re-coupled, since the capabilities of the mode may have changes when the User Preset file was last saved.

Initial S/W Revision	Prior to A.02.00
----------------------	------------------

Save User Preset

Saves the currently active mode and its State. You can recall this User Preset file by pressing the User Preset menu key or sending the SYST:PRES:USER remote command. This same state is also saved by the Save State function.

Key Path	User Preset
Remote Command	:SYSTem:PRESet:USER:SAVE
Example	:SYST:PRES:USER:SAVE
Notes	:SYST:PRES:SAVE creates the same file as if the user requested a *SAV or a MMEM:STOR:STAT, except User Preset Save does not allow the user to specify the filename or the location of the file.
Initial S/W Revision	Prior to A.02.00

View/Display

The View/Display key opens the Display Menu (common to most measurements) and the View menu for the current measurement.

Only two views are available for the List Sequencer measurement: the Results Metric View, and the RF envelope view. The RF envelope view is only available when basic IQ data is captured in Sequence Analyzer mode.

Key Path	Front-panel key
Initial S/W Revision	A.05.00

Display

The Display menu is common to most measurements, and is used for configuring items on the display. Some Display menu settings apply to all the measurements in a mode, and some only to the current measurement. Those under the **System Display Settings** key apply to all measurements in all modes.

Key Path	Display
Key Path	View/Display
Initial S/W Revision	Prior to A.02.00

Annotation

Turns on and off various parts of the display annotation. The annotation is divided up into four categories:

1. Meas Bar: This is the measurement bar at the top of the screen. It does not include the settings panel or the Active Function. Turning off the Meas Bar turns off the settings panel and the Active Function. When the Meas Bar is off, the graticule area expands to fill the area formerly occupied by the Meas Bar.
2. Screen Annotation: this is the annotation and annunciation around the graticule, including any annotation on lines (such as the display line, the threshold line, etc.) This does NOT include the marker number or the N dB result. When off, the graticule expands to fill the entire graticule area.
3. Trace annotation: these are the labels on the traces, showing their detector (or their math mode).
4. Active Function annotation: this is the active function display in the meas bar, and all of the active function values displayed on softkeys.

See the figure below. Each type of annotation can be turned on and off individually.

8 Complex Spectrum Measurement
View/Display

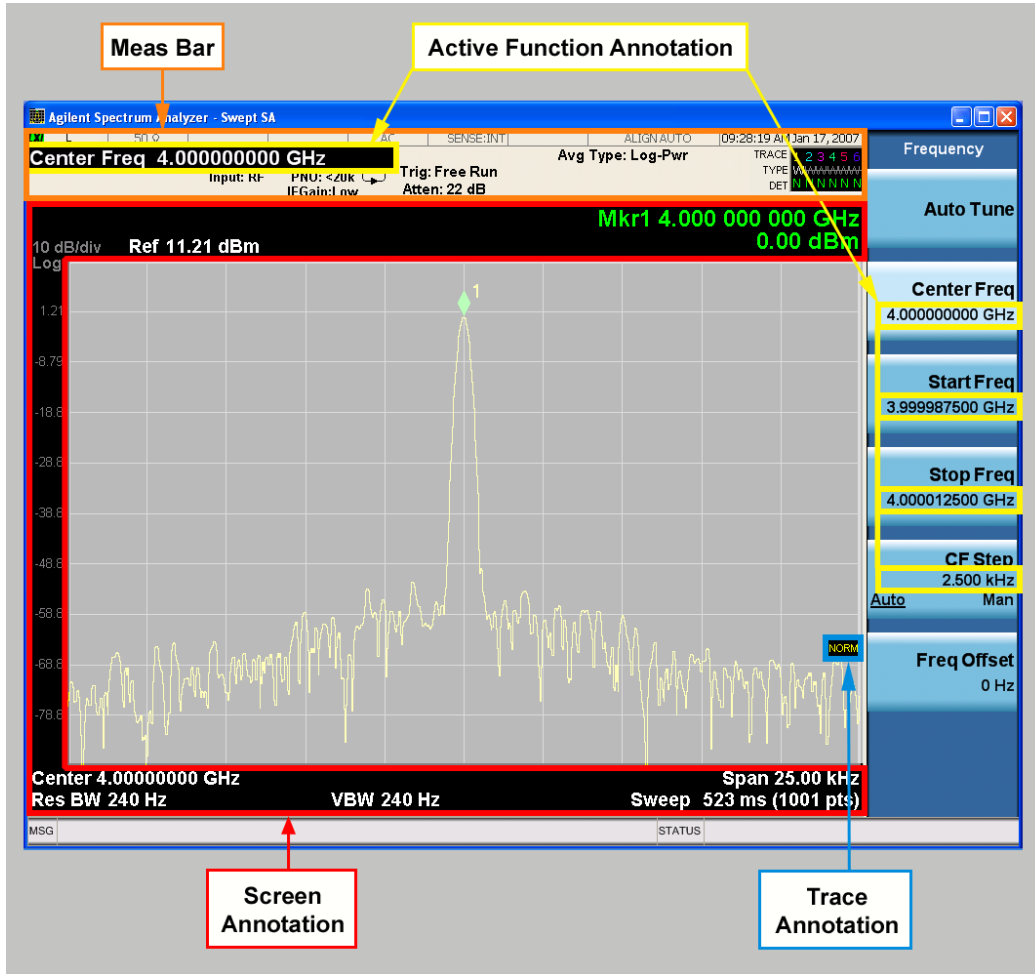

Key Path	View/Display, Display
Initial S/W Revision	Prior to A.02.00

Meas Bar On/Off

This function turns the Measurement Bar on and off, including the settings panel. When off, the graticule area expands to fill the area formerly occupied by the Measurement Bar.

Key Path	View/Display, Display, Annotation
Remote Command	:DISPlay:ANNOtation:MBAR[:STATe] OFF ON 0 1 :DISPlay:ANNOtation:MBAR[:STATe]?
Example	DISP:ANN:MBAR OFF
Dependencies	Grayed out and forced to OFF when System Display Settings, Annotation is set to Off.
Preset	On This should remain Off through a Preset when System DisplaySettings, Annotation is set to Off.

State Saved	Saved in instrument state.
Initial S/W Revision	Prior to A.02.00

Screen

This controls the display of the annunciation and annotation around the graticule, including any annotation on lines (such as the display line, the threshold line, etc.) and the y-axis annotation. This does NOT include marker annotation (or the N dB result). When off, the graticule expands to fill the entire graticule area, leaving only the 1.5% gap above the graticule as described in the Trace/Detector chapter.

Key Path	View/Display, Display, Annotation
Remote Command	:DISPlay:ANNotation:SCReen[:STATe] OFF ON 0 1 :DISPlay:ANNotation:SCReen[:STATe]?
Example	DISP:ANN:SCR OFF
Dependencies	Grayed-out and forced to OFF when System Display Settings, Annotation is set to Off.
Preset	On This should remain Off through a Preset when System DisplaySettings, Annotation is set to Off
State Saved	Saved in instrument state.
Initial S/W Revision	Prior to A.02.00

Active Function Values On/Off

Turns on and off the active function display in the Meas Bar, and all of the active function values displayed on the softkeys.

Note that all of the softkeys that have active functions have these numeric values blanked when this function is on. This is a security feature..

8 Complex Spectrum Measurement View/Display

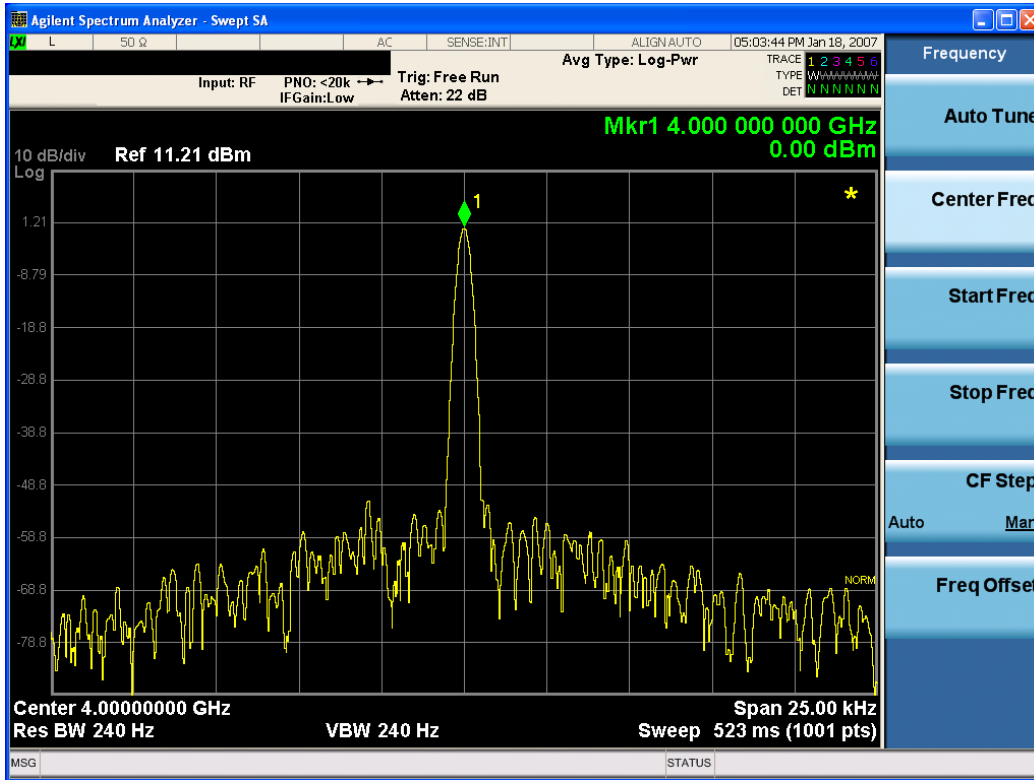

Key Path	View/Display, Display, Annotation
Remote Command	:DISPlay:ACTivefunc[:STATE] ON OFF 1 0 :DISPlay:ACTivefunc[:STATE] ?
Example	DISP:ACT OFF
Dependencies	Grayed out and forced to OFF when System Display Settings, Annotation is set to Off.
Preset	On This should remain Off through a Preset when System DisplaySettings, Annotation is set to Off
State Saved	Saved in instrument state.
Initial S/W Revision	Prior to A.02.00

Title

Displays menu keys that enable you to change or clear a title on your display.

Key Path	View/Display, Display
Initial S/W Revision	Prior to A.02.00

Change Title

Writes a title into the "measurement name" field in the banner, for example, "Swept SA".

Press Change Title to enter a new title through the alpha editor. Press Enter or Return to complete the entry. Press ESC to cancel the entry and preserve your existing title.

The display title will replace the measurement name. It remains for this measurement until you press **Change Title** again, or you recall a state, or a Preset is performed. A title can also be cleared by pressing **Title, Clear Title**.

NOTE

Notice the inclusion of the <measurement> parameter in the command below. Because each measurement remembers the Display Title, the command must be qualified with the measurement name. For the Swept SA measurement this is not the case; no <measurement> parameter is used when changing the Display Title for the Swept SA measurement.

Key Path	View/Display, Display, Title
Mode	All
Remote Command	:DISPlay:<measurement>:ANNotation:TITLe:DATA <string> :DISPlay:<measurement>:ANNotation:TITLe:DATA?
Example	DISP:ANN:TITL:DATA "This Is My Title" This example is for the Swept SA measurement in the Spectrum Analyzer mode. The SANalyzer <measurement> name is not used. DISP:ACP:ANN:TITL:DATA "This Is My Title" This example is for Measurements other than Swept SA. Both set the title to: This Is My Title
Notes	Pressing this key cancels any active function. When a title is edited the previous title remains intact (it is not cleared) and the cursor goes at the end so that characters can be added or BKSP can be used to go back over previous characters.
Preset	No title (measurement name instead)
State Saved	Saved in instrument state.
Initial S/W Revision	Prior to A.02.00

Clear Title

Clears a title from the front-panel display. Once cleared, the title cannot be retrieved. After the title is cleared, the current Measurement Name replaces it in the title bar.

Key Path	View/Display, Display, Title
Example	The following commands clear the title and restore the measurement's original title: DISP:ANN:TITL:DATA "" This example is for the Swept SA measurement in the Spectrum Analyzer mode. The SANalyzer <measurement> name is not used. DISP:ACP:ANN:TITL:DATA "" This example is for ACP; in measurements other than Swept SA the measurement name is required.
Notes	Uses the :DISPlay:<measurement>:ANNotation:TITLe:DATA <string> command with an empty string (in the Swept SA, the <measurement> is omitted).

Preset	Performed on Preset.
Initial S/W Revision	Prior to A.02.00

Graticule

Pressing Graticule turns the display graticule On or Off. It also turns the graticule y-axis annotation on and off.

Key Path	View/Display, Display
Remote Command	:DISPlay:WINDow[1]:TRACe:GRATicule:GRID[:STATe] OFF ON 0 1 :DISPlay:WINDow[1]:TRACe:GRATicule:GRID[:STATe]?
Example	DISP:WIND:TRAC:GRAT:GRID OFF
Notes	The graticule is the set of horizontal and vertical lines that make up the grid/divisions for the x-axis and y-axis.
Preset	On
State Saved	Saved in instrument state
Initial S/W Revision	Prior to A.02.00

System Display Settings

These settings are "Mode Global" – they affect all modes and measurements and are reset only by **Restore Misc Defaults** or **Restore System Defaults** under System.

Key Path	View/Display, Display
Initial S/W Revision	Prior to A.02.00

Annotation Local Settings

This is a Mode Global override of the meas local annotation settings. When it is **All Off**, it forces **ScreenAnnotation, Meas Bar, Trace, and Active Function Values** settings to be **OFF** for all measurements in all modes. This provides the security based "annotation off" function of previous analyzers; hence it uses the legacy SCPI command.

When it is **All Off**, the **Screen, Meas Bar, Trace, and Active Function Values** keys under the **Display, Annotation** menu are grayed out and forced to **Off**. When **Local Settings** is selected, you are able to set the local annotation settings on a measurement by measurement basis.

Key Path	View/Display, Display, System Display Settings
Remote Command	:DISPlay:WINDow[1]:ANNotation[:ALL] OFF ON 0 1 :DISPlay:WINDow[1]:ANNotation[:ALL]?
Example	:DISP:WIND:ANN OFF

Preset	On (Set by Restore Misc Defaults)
State Saved	Not saved in instrument state.
Backwards Compatibility Notes	The WINDow parameter and optional subopcode is included for backwards compatibility but ignored – all windows are equally affected.
Initial S/W Revision	Prior to A.02.00

Themes

Accesses a menu of functions that enable you to choose the theme to be used when saving the screen image.

The **Themes** option is the same as the **Themes** option under the **Display** and **Page Setup** dialogs. It allows you to choose between themes to be used when saving the screen image.

Key Path	Save, Screen Image
Remote Command	:MMEMory:STORe:SCReen:THEMe TDColor TDMonochrome FCOLOR FMONochrome :MMEMory:STORe:SCReen:THEMe?
Example	:MMEM:STOR:SCR:THEM TDM
Preset	3D Color; Is not part of Preset, but is reset by Restore Misc Defaults or Restore System Defaults All and survives subsequent running of the modes.
Readback	3D Color 3D Mono Flat Color Flat Mono
Backwards Compatibility Notes	In ESA and PSA we offer the choice of "Reverse Bitmap" or "Reverse Metafile" when saving screen images. This is much like the "Flat Color" theme available in X-Series. Also, if you selected Reverse Bitmap AND a black & white screen image, that would be much like "Flat Monochrome". In other words, each of the X-Series themes has a similar screen image type in ESA/PSA. But they are not identical.
Initial S/W Revision	Prior to A.02.00

3D Color

Selects a standard color theme with each object filled, shaded and colored as designed.

Key Path	Save, Screen Image, Themes
Example	MMEM:STOR:SCR:THEM TDC
Readback	3D Color
Initial S/W Revision	Prior to A.02.00

3D Monochrome

Selects a format that is like 3D color but shades of gray are used instead of colors.

Key Path	Save, Screen Image, Themes
Example	MMEM:STOR:SCR:THEM TDM
Readback	3D Mono
Initial S/W Revision	Prior to A.02.00

Flat Color

Selects a format that is best when the screen is to be printed on an ink printer.

Key Path	Save, Screen Image, Themes
Example	MMEM:STOR:SCR:THEM FCOL
Readback	Flat Color
Initial S/W Revision	Prior to A.02.00

Flat Monochrome

Selects a format that is like Flat Color. But only black is used (no colors, not even gray), and no fill.

Key Path	Save, Screen Image, Themes
Example	MMEM:STOR:SCR:THEM FMON
Readback	Flat Mono
Initial S/W Revision	Prior to A.02.00

9 Waveform Measurement

The waveform measurement is a generic measurement for viewing the input signal waveforms in the time domain. This measurement represents how the instrument performs the zero span functionality found in traditional spectrum analyzers. For more details, see ["Waveform Measurement Description" on page 524](#) below.

This topic contains the following sections:

["Measurement Commands for Waveform" on page 522](#)

["Remote Command Results for the Waveform Measurement" on page 523](#)

Measurement Commands for Waveform

The general functionality of CONFigure, INITiate, FETCh, MEASure, and READ are described at this section.

:CONFigure:WAVEform

:CONFigure:WAVEform:NDEFault

:INITiate:WAVEform

:FETCh:WAVEform[n]?

:MEASure:WAVEform[n]?

:READ:WAVEform[n]?

For more measurement related commands, see the SENSE subsystem, and the section "[Remote Measurement Functions](#)" on page 557.

Remote Command Results for the Waveform Measurement

The following table denotes the returned results from the FETCh|MEASure|READ commands:

n	Results Returned
0	Returns unprocessed I/Q trace data, as a series of trace point values, in volts. The I values are listed first in each pair, using the 0 through even-indexed values. The Q values are the odd-indexed values.
1	<p>Returns the following scalar results:</p> <ol style="list-style-type: none"> 1. Sample Time is a floating point number representing the time between samples when using the trace queries (n=0, 2, and so forth). 2. Mean Power is the mean power (in dBm). This is the power across the entire trace. If averaging is on, the power is for the latest acquisition. 3. Mean Power Averaged is the power (in dBm) for N averages, if averaging is on. This is the power across the entire trace. If averaging is on, the power is for the latest acquisition. If averaging is off, the value of the mean power averaged is the same as the value of the mean power. 4. Number of samples is the number of data points in the captured signal. This number is useful when performing a query on the signal (i.e. when n=0, 2, etc.). 5. Peak-to-mean ratio has units of dB. This is the ratio of the maximum signal level to the mean power. Valid values are only obtained with averaging turned off. If averaging is on, the peak-to-mean ratio is calculated using the highest peak value, rather than the displayed average peak value. 6. Maximum value is the maximum of the most recently acquired data (in dBm). 7. Minimum value is the minimum of the most recently acquired data (in dBm).
2	Returns trace point values of the entire captured signal envelope trace data. These data points are floating point numbers representing the power of the signal (in dBm). There are N data points, where N is the number of samples. The period between the samples is defined by the sample time.

Waveform Measurement Description

Also available under the basic Waveform measurement is an I/Q window, which shows the I and Q signal waveforms in parameters of voltage versus time to disclose the voltages that comprise the complex modulated waveform of a digital signal.

The waveform measurement can also be used to perform general purpose power measurements to a high degree of accuracy.

Key Path	Front-panel key
Initial S/W Revision	Prior to A.02.00

AMPTD Y Scale

Accesses a menu of functions that enable you to set the vertical scale parameters.

Key Path	Front-panel key
Initial S/W Revision	Prior to A.02.00

Ref Value (RF Envelope View)

Sets the Y Scale reference value (in dBm) when the RF Envelope View is active. By default, the measurement determines the reference value with Auto Scaling. Entering a reference value manually turns Auto Scaling off.

Key Path	AMPTD Y Scale
Mode	BASIC, PNOISE, WCDMA, C2K, GSM, WIMAXOFDMA, TDSCDMA, 1XEVD0, DVB, DTMB, ISDBT, CMMB, LTE, LTETDD, DCATV, WLAN,LTEATDD, LTEAFDD
Remote Command	:DISPlay:WAVeform:VIEW[1]:WINDow[1]:TRACe:Y[:SCALE]:RLEVel <ampl> :DISPlay:WAVeform:VIEW[1]:WINDow[1]:TRACe:Y[:SCALE]:RLEVel?
Example	DISP:WAV:VIEW:WIND:TRAC:Y:RLEV -50 dBm DISP:WAV:VIEW:WIND:TRAC:Y:RLEV?
Notes	You must be in the mode that includes Waveform measurement to use this command. Use INSTRument:SElect to set the mode.
Couplings	When Auto Scaling is On, this value is automatically determined by the measurement result. When you set a value manually, Auto Scaling automatically changes to Off.
Preset	10.00 dBm
State Saved	Saved in instrument state.
Range	-250.00 dBm to 250.00 dBm
Min	-250.00 dBm
Max	250.00 dBm
Initial S/W Revision	Prior to A.02.00
Modified at S/W Revision	A.03.00

Range

Represents the amplitude of the largest sinusoidal signal that could be present within the IF without being clipped by the ADC. For signals with high peak-to-average ratios, the range may need to exceed the rms signal power by a fair amount to avoid clipping.

Key Path	Range
Mode	BASIC
Remote Command	[:SENSe]:POWer[:RF]:RANGe <real>

	<code>[:SENSe] :POWeR [:RF] :RANGe?</code>
Example	<code>:POW:RANG 10.0</code> <code>:POW:RANG?</code>
Notes	The MIN and MAX values are affected by the External Gain parameters, and by the Center Frequency. (The hardware compensates for frequency response and alters the Range setting.)
Preset	0
State Saved	Saved in instrument state.
Min	-100
Max	100
Initial S/W Revision	A.12.50

Peak to Average

The Peak to Average Ratio is used with the Range setting to optimize the level control in the instrument. The value is the ratio, in dB, of the peak power to the average power of the signal to be measured. A ratio of 0 should be used for sinusoidal signals; for 802.11g OFDM signals use 9 dB.

All Applications (Modes) will show the current value of Peak to Average ratio on the softkey. However, some applications will not permit changing the value. In these situations the softkey will be grayed-out.

Key Path	AMPTD Y Scale, Range
Remote Command	<code>[:SENSe] :POWeR [:RF] :RANGe:PARatio <real></code> <code>[:SENSe] :POWeR [:RF] :RANGe:PARatio?</code>
Example	<code>POW:RANG:PAR 12 dB</code>
Notes	In some Applications (Modes) this parameter will be read-only; meaning the value will appear on the softkey and query via SCPI, but not changeable. In such applications the softkey will be grayed-out. Attempting to change the value via SCPI will be ignored and no error message will be generated.
Preset	10 dB
State Saved	Saved in instrument state
Min	0 dB
Max	20 dB
Initial S/W Revision	A.13.00

Mixer Level Offset

Mixer level offset is an advanced setting to adjust target Range at the input mixer which in turn affects the signal level in the instrument's IF. This setting can be used when additional optimization is needed after setting Peak to Average ratio. Positive values of offset optimize noise performance over distortion, negative values optimize distortion performance over noise.

Key Path	AMPTD Y Scale, Range
-----------------	-----------------------------

Remote Command	<code>[:SENSe] :POWer [:RF] :RANGe :MIXer :OFFSet <real></code> <code>[:SENSe] :POWer [:RF] :RANGe :MIXer :OFFSet ?</code>
Example	POW:RANG:MIX:OFFS -5 dB
Preset	0 dB
State Saved	Saved in instrument state
Min	-35 dB
Max	30 dB
Initial S/W Revision	A.13.00

Scale/Div (RF Envelope View)

Sets the scale per division for the RF Envelope result waveform (time domain) measurements in the graph window.

Key Path	AMPTD Y Scale
Mode	BASIC, PNOISE, WCDMA, C2K, GSM, WIMAXOFDMA, TDSCDMA, 1XEVD0, DVB, DTMB, ISDBT, CMMB, LTE, LTETDD, DCATV, WLAN, LTEATDD, LTEAFDD
Remote Command	<code>:DISPlay:WAVeform:VIEW[1]:WINDow[1]:TRACe:Y[:SCALe]:PDIVision <rel_ ampl></code> <code>:DISPlay:WAVeform:VIEW[1]:WINDow[1]:TRACe:Y[:SCALe]:PDIVision?</code>
Example	DISP:WAV:VIEW:WIND:TRAC:Y:PDIV 5 DISP:WAV:VIEW:WIND:TRAC:Y:PDIV?
Notes	You must be in a mode that includes the Waveform measurement to use this command. Use INSTRUMENT:SElect to set the mode.
Couplings	When Auto Scaling is On, this value is automatically determined by the measurement result. When you set a value manually, Auto Scaling automatically changes to Off.
Preset	10.00 dB
State Saved	Saved in instrument state.
Range	0.10 dB to 20.00 dB
Min	0.10 dB
Max	20.00 dB
Initial S/W Revision	Prior to A.02.00
Modified at S/W Revision	A.03.00

Ref Position (RF Envelope View)

Positions the reference level at the top, center or bottom of the Y Scale display. Changing the reference position does not change the reference level value.

Key Path	AMPTD Y Scale
Mode	BASIC, PNOISE, WCDMA, C2K, GSM, WIMAXOFDMA, TDSCDMA, 1XEVD0, DVB, DTMB, ISDBT, CMMPB, LTE, LTETDD, DCATV, WLAN,LTEATDD, LTEAFDD
Remote Command	:DISPlay:WAVeform:VIEW[1]:WINDow[1]:TRACe:Y[:SCALE]:RPOSition TOP CENTER BOTTom :DISPlay:WAVeform:VIEW[1]:WINDow[1]:TRACe:Y[:SCALE]:RPOSition?
Example	DISP:WAV:VIEW:WIND:TRAC:Y:RPOS CENT DISP:WAV:VIEW:WIND:TRAC:Y:RPOS?
Notes	You must be in a mode that includes the Waveform measurement to use this command. Use INSTRument:SElect to set the mode.
Preset	TOP
State Saved	Saved in instrument state.
Range	Top Ctr Bot
Initial S/W Revision	Prior to A.02.00
Modified at S/W Revision	A.03.00

Auto Scaling

Toggles the Auto Scaling function between On and Off. When the **Restart** front-panel key is pressed, this function automatically determines the scale per division and reference values based on the measurement results.

Key Path	AMPTD Y Scale
Mode	BASIC, PNOISE, WCDMA, C2K, GSM, WIMAXOFDMA, TDSCDMA, 1XEVD0, DVB, DTMB, ISDBT, CMMPB, LTE, LTETDD, DCATV, WLAN,LTEATDD, LTEAFDD
Remote Command	:DISPlay:WAVeform:VIEW[1] 2:WINDow[1]:TRACe:Y[:SCALE]:COUPle 0 1 OFF ON :DISPlay:WAVeform:VIEW[1] 2:WINDow[1]:TRACe:Y[:SCALE]:COUPle?
Example	DISP:WAV:VIEW:WIND:TRAC:Y:COUP OFF DISP:WAV:VIEW:WIND:TRAC:Y:COUP?
Notes	You must be in a mode that includes the Waveform measurement to use this command. Use INSTRument:SElect to set the mode.
Couplings	When Auto Scaling is On, upon pressing the Restart front-panel key, this function automatically switches the scale per division and reference values into the defaults. When you set a value to either Scale/Div or Ref Value manually, Auto Scaling automatically changes to Off.
Preset	OFF
State Saved	Saved in instrument state.
Range	On Off
Initial S/W Revision	Prior to A.02.00
Modified at S/W Revision	A.03.00

Auto Couple

The Auto Couple feature provides a quick and convenient way to automatically couple multiple instrument settings. This helps ensure accurate measurements and optimum dynamic range. When the Auto Couple feature is activated, either from the front panel or remotely, all parameters of the current measurement that have an Auto/Manual mode are set to Auto mode and all measurement settings dependent on (or coupled to) the Auto/Man parameters are automatically adjusted for optimal performance.

However, the Auto Couple key actions are confined to the current measurement only. It does not affect other measurements in the mode, and it does not affect markers, marker functions, or trace or display attributes.

See ["More Information" on page 530](#)

Key Path	Front-panel key
Remote Command	:COUPLe ALL NONE
Example	:COUP ALL
Notes	:COUPLe ALL puts all Auto/Man parameters in Auto mode (equivalent to pressing the Auto Couple key). :COUPLE NONE puts all Auto/Man parameters in manual mode. It decouples all the coupled instrument parameters and is not recommended for making measurements.
Initial S/W Revision	Prior to A.02.00

More Information

There are two types of functions that have Auto/Manual modes.

Auto/Man Active Function keys

An Auto/Man toggle key controls the binary state associated with an instrument parameter by toggling between **Auto** (where the parameter is automatically coupled to the other parameters it is dependent upon) and **Man** (where the parameter is controlled independent of the other parameters), as well as making the parameter the active function. The current mode is indicated on the softkey with either **Auto** or **Man** underlined as illustrated below.

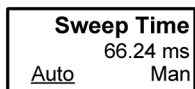

vsd07

Auto/Man 1-of-N keys

An Auto/Man 1-of-N key allows you to manually pick from a list of parameter values, or place the function in Auto, in which case the value is automatically selected (and indicated) as shown below. If in Auto, Auto is underlined on the calling key. If in manual operation, manual is indicated on the calling key. But the calling key does not actually toggle the function, it simply opens the menu.

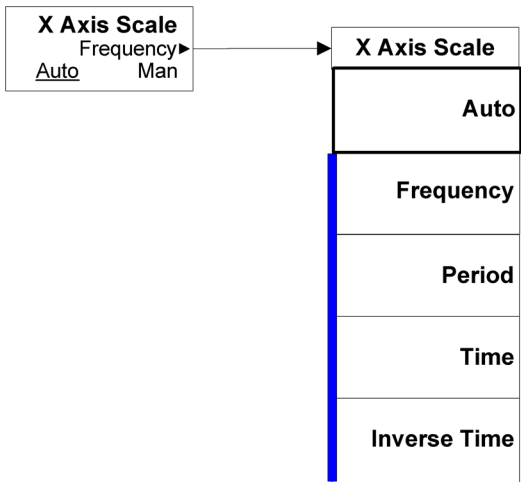

vsd08

BW

Accesses a menu that enables you to control the information bandwidth functions of the instrument. You can also select the filter type for the measurement.

Key Path	Front-panel key
Initial S/W Revision	Prior to A.02.00

Digital IF BW

Enables you to set the Digital IF (formerly Info BW) bandwidth of the instrument.

Key Path	BW
Mode	BASIC, PNOISE, WCDMA, C2K, GSM, WIMAXOFDMA, TD-SCDMA, 1xEVDO, DVB, DTMB, ISDBT, CMMB, LTE, LTETDD, DCATV, WLAN, MSR,LTEATDD, LTEAFDD
Remote Command	[:SENSe] :WAVeform:DIF:BANDwidth <freq> [:SENSe] :WAVeform:DIF:BANDwidth?
Example	WAV:DIF:BAND 1kHz WAV:DIF:BAND?
Remote Command Notes	You must be in a mode that includes the Waveform measurements to use this command. Use INSTRument:SElect to set the mode.
Dependencies	The maximum value is the maximum Digital IF BW available in the instrument. With Option B85 the maximum value is 85 MHz, with Option B1Y the maximum value is 160 MHz.
Preset	All except the following list: 100 kHz GSM/EDGE: 510 kHz TDSCDMA: 1.3 MHz 1xEVDO: 1.3 MHz DVB-T/H: 8.0 MHz DTMB (CTTB): 8.0 MHz ISDB-T: 6.0 MHz CMMB: 8.0 MHz Digital Cable TV: 8 MHz LTEAFDD, LTEATDD: 6 MHz LTETDD: 6 MHz LTE: 6 MHz WLAN: Hardware Dependent No option = 10 MHz Option B25 = 25 MHz Option B40: if Radio Std is 802.11a/b/g/n(20MHz) = 25 MHz

	if Radio Std is 802.11n(40MHz) = 40 MHz if Radio Std is 802.11ac(20MHz) = 25 MHz if Radio Std is 802.11ac(40MHz) = 40 MHz Option B1X: if Radio Std is 802.11ac(80MHz) = 80 MHz Option B1Y: if Radio Std is 802.11ac(160MHz) = 160 MHz
State Saved	Saved in instrument state.
Min	10 Hz
Max	Hardware Dependent: RF Input: No Option = 10 MHz Option B25 = 25 MHz Option B40 = 40 MHz Option B85 = 85.0 MHz Option B1A = 125.0 MHz Option B1X = 140 MHz Option B1Y = 160 MHz
Backwards Compatibility SCPI	<code>[:SENSe] :WAVeform :BANDwidth [:RESolution]</code> <code>[:SENSe] :WAVeform :BWIDth [:RESolution]</code>
Initial S/W Revision	Prior to A.02.00
Modified at S/W Revision	A.03.00, A.13.00

Filter Type

Selects the type of bandwidth filter that is used.

Besides the Gaussian filter shape, a variety of other filter types are available with variable alpha settings for maximum control over the filter shape..

Key Path	BW
Mode	BASIC, PNOISE, WCDMA, C2K, GSM, WIMAXOFDMA, TDSCDMA, 1XEVD0, DVB, DTMB, ISDBT, CMMB, LTE, LTETDD, DCATV, WLAN, MSR,,LTEATDD, LTEAFDD
Remote Command	<code>[:SENSe] :WAVeform :DIF :FILTer :TYPE GAUSSian FLATtop</code> <code>[:SENSe] :WAVeform :DIF :FILTer :TYPE?</code> (With DIF40 and/or WBDIF) <code>[:SENSe] :WAVeform :DIF :FILTer :TYPE GAUSSian FLATtop SNYQuist RSNYquist RCOSine RRCosine</code> <code>[:SENSe] :WAVeform :DIF :FILTer :TYPE?</code>
Example	<code>WAV:DIF:FILT:TYPE GAUS</code> <code>WAV:DIF:FILT:TYPE?</code>

Remote Command Notes	You must be in a mode that includes the Waveform measurements to use this command. Use INSTRUMENT:SELEct to set the mode.
Dependencies	Gaussian and Flattop are available in all DIF configurations. For the other filter types, the filters are only available when Option DP2, B40, or wider IF Bandwidth option is installed.
Preset	BASIC with DP2, B40, or wider IF Bandwidth option: FLATtop All other apps: GAUSSian
State Saved	Saved in instrument state.
Range	Gaussian FlatTop When Option DP2, B40, or wider IF Bandwidth option is installed, the range is as follows. Gaussian FlatTop Short nyquist Root Short Nquist Raised Cosine Root RaisedCosine
Backwards Compatibility SCPI	[:SENSe] :WAVeform :BANDwidth :SHAPE [:SENSe] :WAVeform :BWIDth :SHAPE [:SENSe] :WAVeform :BANDwidth BWIDth [:RESolution] :TYPE
Initial S/W Revision	Prior to A.02.00
Modified at S/W Revision	A.03.00, A.13.00

Filter BW

This feature is only available when Option DP2, B40, or wider IF Bandwidth option is installed.

Key Path	BW
Mode	BASIC
Remote Command	[:SENSe] :WAVeform :DIF :FILTer :BANDwidth <freq> [:SENSe] :WAVeform :DIF :FILTer :BANDwidth? [:SENSe] :WAVeform :DIF :FILTer :BANDwidth :AUTO ON OFF 1 0 [:SENSe] :WAVeform :DIF :FILTer :BANDwidth :AUTO?
Example	WAV:DIF:FILT:BAND 1MHz WAV:DIF:FILT:BAND? WAV:DIF:FILT:BAND:AUTO 0 WAV:DIF:FILT:BAND:AUTO?
Notes	You must be in the IQ Analyzer (Basic) mode to use this command. Use INSTRUMENT:SELEct to set the mode.
Dependencies	This feature is only available when Option DP2, B40, or wider IF Bandwidth option is installed.
Couplings	Sets the same value as the current Digital IF BW value upon a preset or when Channel Filter Bandwidth Auto is ON.
Preset	Same value as Digital IF BW ON
State Saved	Saved in instrument state.

Min	10 Hz
Max	Clipped to the current Digital IF BW value.
Initial S/W Revision	A.04.00, A.13.00

Filter Alpha

Sets the filter alpha for the DIF filter. This feature is only available when Option DP2, B40, or wider IF Bandwidth option is installed.

Key Path	BW
Mode	BASIC
Remote Command	<code>[:SENSe] :WAVeform:DIF:FILTer:ALPHa <real></code> <code>[:SENSe] :WAVeform:DIF:FILTer:ALPHa?</code>
Example	<code>WAV:DIF:FILT:ALPH 0.5</code> <code>WAV:DIF:FILT:ALPH?</code>
Notes	You must be in the IQ Analyzer (Basic) mode to use this command. Use INSTRument:SElect to set the mode.
Dependencies	This feature is only available when Option DP2, B40, or wider IF Bandwidth option is installed.
Preset	0.2
State Saved	Saved in instrument state.
Min	0.01
Max	1.00
Backwards Compatibility SCPI	<code>[:SENSe] :WAVeform:WBIF:FILTer:ALPHa</code>
Modified at S/W Revision	A.13.00

Cont (Continuous Measurement/Sweep)

Sets the analyzer for Continuous measurement operation. The single/continuous state is Meas Global so the setting will affect all measurements. If you are Paused, pressing **Cont** does a Resume.

Key Path	Front-panel key
Remote Command	:INITiate:CONTinuous OFF ON 0 1 :INITiate:CONTinuous?
Example	:INIT:CONT 0 puts analyzer in Single measurement operation. :INIT:CONT 1 puts analyzer in Continuous measurement operation
Preset	ON (Note that SYST:PRESet sets INIT:CONT to ON but *RST sets INIT:CONT to OFF)
State Saved	Saved in instrument state
Backwards Compatibility Notes	For Spectrum Analysis mode in ESA and PSA, there is no Cont hardkey, instead there is a Sweep Single/Cont key. In these analyzers, switching the Sweep Single/Cont key from Single to Cont restarts averages (displayed average count reset to 1), but does not restart Max Hold and Min Hold . The X-Series has Single and Cont keys in place of the SweepSingleCont key. In the X-Series, if in single measurement, the Cont key (and INIT:CONT ON) switches to continuous measurement, but never restarts a measurement and never resets a sweep.
Initial S/W Revision	Prior to A.02.00

In Swept SA Measurement (Spectrum Analysis Mode):

The analyzer takes repetitive sweeps, averages, measurements, etc., when in Continuous mode. When the average count reaches the Average/Hold Number the count stops incrementing, but the analyzer keeps sweeping. See the Trace/Detector section for the averaging formula used both before and after the Average/Hold Number is reached. The trigger condition must be met prior to each sweep. The type of trace processing for multiple sweeps, is set under the Trace/Detector key, with choices of **Trace Average**, **Max Hold**, or **Min Hold**.

In Other Measurements/Modes:

With **Avg/Hold Num** (in the **Meas Setup** menu) set to **Off** or set to **On** with a value of 1, a sweep is taken after the trigger condition is met; and the analyzer continues to take new sweeps after the current sweep has completed and the trigger condition is again met. However, with **Avg/Hold Num** set to **On** with a value >1, multiple sweeps (data acquisitions) are taken for the measurement. The trigger condition must be met prior to each sweep. The sweep is not stopped when the average count k equals the number N set for Avg/Hold Num is reached, but the number k stops incrementing. A measurement average usually applies to all traces, marker results, and numeric results. But sometimes it only applies to the numeric results.

If the analyzer is in Single measurement, pressing the **Cont** key does not change k and does not cause the sweep to be reset; the only action is to put the analyzer into Continuous measurement operation.

If it is already in continuous sweep:

the INIT:CONT 1 command has no effect

the INIT:CONT 0 command will place the analyzer in Single Sweep but will have no effect on the current sequence until $k = N$, at which point the current sequence will stop and the instrument will go to the idle state.

9 Waveform Measurement
File

File

See "File" on page 160

Frequency/Channel

Opens a menu that enables you to control the Center Frequency of the instrument.

Key Path	Front-panel key
Initial S/W Revision	Prior to A.02.00

Center Freq

Sets the frequency that corresponds to the horizontal center of the graticule (when frequency Scale Type is set to linear). While adjusting the Center Frequency the Span is held constant, which means that both Start Frequency and Stop Frequency will change.

Pressing Center Freq also sets the frequency entry mode to Center/Span. In Center/Span mode, the center frequency and span values are displayed below the graticule, and the default active function in the Frequency menu is **Center Freq**.

The center frequency setting is the same for all measurements within a mode, that is, it is Meas Global. Some modes are also able to share a Mode Global center frequency value. If this is the case, the Mode will have a **Global Settings** key in its **Mode Setup** menu.

The **Center Freq** function sets (and queries) the Center Frequency for the currently selected input. If your analyzer has multiple inputs, and you select another input, the Center Freq changes to the value for that input. SCPI commands are available to directly set the Center Freq for a specific input.

Center Freq is remembered as you go from input to input. Thus you can set a Center Freq of 10 GHz with the RF Input selected, change to BBIQ and set a Center Freq of 20 MHz, then switch to External Mixing and set a Center Freq of 60 GHz, and when you go back to the RF Input the Center Freq will go back to 10 GHz; back to BBIQ and it is 20 MHz; back to External Mixing and it is 60 GHz.

See ["RF Center Freq" on page 542](#)

See [Ext Mix Center Freq](#)

See ["I/Q Center Freq" on page 544](#)

See ["Center Frequency Presets" on page 540](#)

Key Path	FREQ Channel
Scope	Meas Global
Remote Command	[:SENSe] :FREQuency:CENTer <freq> [:SENSe] :FREQuency:CENTer?
Example	FREQ:CENT 50 MHz FREQ:CENT UP changes the center frequency to 150 MHz if you use FREQ:CENT:STEP 100 MHz to set the center frequency step size to 100 MHz FREQ:CENT?
Notes	This command sets either the RF or I/Q Center Frequency depending on the selected input. For RF input it is equivalent to FREQ:RF:CENT

	<p>For I/Q input it is equivalent to <code>FREQ:IQ:CENT</code></p> <p>Preset and Max values are dependent on Hardware Options (5xx)</p> <p>If no terminator (e.g. MHz) is sent the terminator Hz is used. If a terminator with unit other than Frequency is used, an invalid suffix error message is generated.</p>
Dependencies	<p>The Center Frequency can be limited by Start or Stop Freq limits, if the Span is so large that Start or Stop reach their limit.</p>
Couplings	<p>When operating in “swept span”, any value of the Center Frequency or Span that is within the frequency range of the analyzer is allowed when the value is being set through the front panel numeric key pad or the SCPI command. The other parameter is forced to a different value if needed, to keep the Start and the Stop Frequencies within the analyzer’s frequency range</p>
Preset	<p>Depends on instrument maximum frequency, mode, measurement, and selected input.</p> <p>See "Center Frequency Presets" on page 540 and "RF Center Freq" on page 542 and Ext Mix Center Freq and "I/Q Center Freq" on page 544.</p>
State Saved	<p>Saved in instrument state</p>
Min	<p>Depends on instrument maximum frequency, mode, measurement, and selected input..</p> <p>See "Center Frequency Presets" on page 540 and "RF Center Freq" on page 542 and "I/Q Center Freq" on page 544.</p>
Max	<p>Depends on instrument maximum frequency, mode, measurement, and selected input..</p> <p>See "Center Frequency Presets" on page 540 and "RF Center Freq" on page 542 and "I/Q Center Freq" on page 544.</p>
Default Unit	<p>Hz</p>
Status Bits/OPC	<p>Non-overlapped</p>
Dependencies	
Initial S/W Revision	<p>Prior to A.02.00</p>

Center Frequency Presets

The following table provides the Center Frequency Presets for the Spectrum Analyzer mode, and the Max Freq, for the various frequency options:

Freq Option	CF after Mode Preset	Stop Freq after Mode Preset	Max Freq (can't tune above)
503 (all but N9000A)	1.805 GHz	3.6 GHz	3.7 GHz
503 (N9000A)	1.505 GHz	3.0 GHz	3.08 GHz
507	3.505 GHz	7.0 GHz	7.1 GHz

(all but N9000A)			
507 (N9000A)	3.755 GHz	7.5 GHz	7.58 GHz
508 (all but N9038A)	1.805 GHz	3.6 GHz	8.5 GHz
508 (N9038A)	4.205 GHz	8.4 GHz	8.5 GHz
513	6.805 GHz	13.6 GHz	13.8 GHz
526 (all but N9000A and N9038A)	13.255 GHz	26.5 GHz	27.0 GHz
526 (N9000A)	13.255 GHz	26.5 GHz	26.55 GHz
526 (N9038A)	1.805 GHz	3.6 GHz	27.0 GHz
532	16.005 GHz	32.0 GHz	32.5 GHz
543	21.505 GHz	43.0 GHz	TBD
544	22.005 GHz	44.0 GHz	44.5 GHz
550	25.005 GHz	50.0 GHz	51 GHz

Input 2:

Model	CF after Mode Preset	Stop Freq after Mode Preset	Max Freq (can't tune above)
N9000A opt C75	0.7505GHz	1.5 GHz	1.58 GHz
N9038A	505 MHz	1 GHz	1.000025 GHz

Tracking Generator Frequency Limits (N9000A only):

Tracking Generator Option	Min Freq (clips to this freq when turn TG on and can't tune below while TG on)	If above this Freq, Stop Freq clipped to this Freq when TG turned on	Max Freq (can't tune above) while TG on
T03	9 kHz	3.0 GHz	3.08 GHz
T06	9 kHz	6.0 GHz	6.05 GHz

The following table shows the Center Frequency Presets for modes other than Spectrum Analyzer:

Mode	CF Preset for RF
WCDMA	1 GHz
WIMAXOFDMA, BASIC	1 GHz
ADEMOD	1 GHz
VSA	1 GHz
TDSCDMA	1 GHz
PNOISE	1 GHz
LTE	1 GHz
LTETDD	1 GHz
MSR	1 GHz
GSM	935.2 MHz
NFIGURE	1.505 GHz

RF Center Freq

SCPI command for specifying the RF Center Frequency. This command will set the Center Frequency to be used when the RF input is selected, even if the RF input is not the input that is selected at the time the command is sent. Note that the **Center Freq** function in the **Frequency** menu on the front panel always applies to the currently selected input.

Scope	Meas Global
Remote Command	<code>[:SENSe] :FREQuency:RF:CENTer <freq></code> <code>[:SENSe] :FREQuency:RF:CENTer?</code>
Example	FREQ:RF:CENT 30 MHz
Notes	This command is the same in all modes, but the parameter is Measurement Global. So the value is independent in each mode and common across all the measurements in the mode.
Dependencies	If the electronic/soft attenuator is enabled, any attempt to set Center Frequency such that the Stop Frequency would be >3.6 GHz fails and results in an advisory message. If the equivalent SCPI command is sent, this same message is generated as part of a “-221, Settings conflict” warning. If Source Mode is set to Tracking, and the Max or Min Center Freq is therefore limited by the limits of the source, a warning message is generated, “Data out of range;clipped to source max/min” if these limits are exceeded. Note that for an external source, these limits can be affected by the settings of Source Numerator, Source Denominator and Power Sweep.
Preset	See table above
State Saved	Saved in instrument state.
Min	-79.999995 MHz, unless Source Mode is set to Tracking, in which case it is limited by the minimum frequency of the Source
Max	See table above. Basically instrument maximum frequency – 5 Hz. Note that, if the Source Mode is set to Tracking, the effective instrument maximum frequency may be limited by the source maximum frequency.

	If the knob or step keys are being used, also depends on the value of the other three interdependent parameters Span, Start Frequency and Stop Frequency
Initial S/W Revision	Prior to A.02.00
Modified at S/W Revision	A.03.00

Ext Mix Center Freq

SCPI command for specifying the External Mixer Center Frequency. This command will set the Center Frequency to be used when the External Mixer is selected, even if the External Mixer input is not the input which is selected at the time the command is sent. Note that the **Center Freq** function in the **Frequency** menu on the front panel always applies to the currently selected input.

Scope	Meas Global
Remote Command	<code>[:SENSe] :FREQuency:EMIXer:CENTer <freq></code> <code>[:SENSe] :FREQuency:EMIXer:CENTer?</code>
Example	<code>:FREQ:EMIX:CENT 60 GHz</code> <code>:FREQ:EMIX:CENT?</code>
Notes	This command is the same in all modes, but the parameter is Measurement Global. So the value is independent in each mode and common across all the measurements in the mode.
Couplings	When returning to External Mixing after having been switched to one of the other inputs (e.g., RF), you will come back into the settings that you had when you left External Mixing. So you will come back to the band you were in with the Center Frequency that you had. However, Span is not an input-dependent parameter, therefore you will bring the span over from the other input. Therefore, the analyzer comes back with the span from the previous input, limited as necessary by the current mixer setup.
Preset	<p>When a Mode Preset is performed while in External Mixing, the Start frequency of the current Mode is set to the nominal Min Freq of the lowest harmonic range in the Harmonic Table for the current mixer setup. Similarly, the Stop frequency of the current Mode is set to the nominal Max Freq of the highest harmonic range in the Harmonic Table. The Center Freq thus presets to the point arithmetically equidistant from these two frequencies.</p> <p>If the current measurement has a limited Span available to it, and cannot achieve the Span shown in the table (Span=Stop Freq - Start Freq), the analyzer uses the maximum Span the measurement allows, and still sets the Center Freq to the midpoint of the Start and Stop Freq values in the Harmonic Table.</p> <p>When Restore Input/Output Defaults is performed, the mixer presets to the 11970A, whose Start and Stop frequencies are 26.5 and 40 GHz respectively. The center of these two frequencies is 33.25 GHz.</p> <p>Therefore, after a Restore Input/Output Defaults, if you go into External Mixing and do a Mode Preset while in the Spectrum Analyzer Mode, the resulting Center Freq is 33.25 GHz.</p>
State Saved	Saved in instrument state.
Min	The minimum frequency in the currently selected mixer band + 5 Hz
Max	The maximum frequency in the currently selected mixer band - 5 Hz

	If the knob or step keys are being used, also depends on the value of the other three interdependent parameters Span, Start Frequency and Stop Frequency
Initial S/W Revision	A.08.01

I/Q Center Freq

SCPI command for specifying the I/Q Center Frequency. This command will set the Center Frequency to be used when the I/Q input is selected, even if the I/Q input is not the input which is selected at the time the command is sent. Note that the **Center Freq** function in the **Frequency** menu on the front panel always applies to the currently selected input.

Scope	Meas Global
Remote Command	[:SENSe] :FREQuency:IQ:CENTer <freq> [:SENSe] :FREQuency:IQ:CENTer?
Example	FREQ:IQ:CENt: 30 MHz
Notes	This command is the same in all modes, but the parameter is Measurement Global. So the value is independent in each mode and common across all the measurements in the mode.
Preset	0 Hz
State Saved	Saved in instrument state.
Min	-40.049995 MHz
Max	40.049995 MHz
Initial S/W Revision	Prior to A.02.00

Input/Output

See ["Input/Output" on page 102](#)

Marker

Accesses a menu that enables you to select, set up and control the markers for the current measurement.

Key Path	Front-panel key
Initial S/W Revision	Prior to A.02.00

Select Marker

Displays 12 markers available for selection.

Key Path	Marker
Initial S/W Revision	Prior to A.02.00

Marker Type

Sets the marker control mode to **Normal**, **Delta**, **Fixed** or **Off**. All interactions and dependencies detailed under the key description are enforced when the remote command is sent. If the selected marker is Off, pressing Marker sets it to Normal and places it at the center of the screen on the trace determined by the **Marker Trace** rules. At the same time, the Marker X Axis Value appears on the Active Function area.

The default active function is the active function for the currently selected marker control mode. If the current control mode is Off, there is no active function and the active function is turned off.

Key Path	Marker
Mode	BASIC, PNOISE, WCDMA, C2K, GSM, WIMAXOFDMA, TDSCDMA, 1XEVD0, DVB, DTMB, ISDBT, CMMB, LTE, LTETDD, DCATV, WLAN,,LTEATDD, LTEAFDD
Remote Command	:CALCulate:WAVeform:MARKer[1] 2 ... 12:MODE POSition DELTa OFF :CALCulate:WAVeform:MARKer[1] 2 ... 12:MODE?
Example	CALC:WAV:MARK:MODE OFF CALC:WAV:MARK:MODE?
Notes	If the selected marker is Off, pressing Marker sets it to Normal and places it at the center of the screen on the trace determined by the Marker Trace rules. At the same time, Marker X Axis Value appears on the Active Function area. Default Active Function: the active function for the selected marker's current control mode. If the current control mode is Off, there is no active function and the active function is turned off. Active Function Display: the marker X axis value entered in the active function area displays the marker value to its full entered precision. You must be in a mode that includes the Waveform measurement to use this command. Use INSTRument:SElect to set the mode.
Preset	OFF
State Saved	Saved in instrument state.

Range	Normal Delta Off
Initial S/W Revision	Prior to A.02.00
Modified at S/W Revision	A.03.00

Properties

Accesses the marker properties menu.

Key Path	Marker
Initial S/W Revision	Prior to A.02.00

Select Marker

Displays 12 markers available for selection.

Key Path	Marker
Initial S/W Revision	Prior to A.02.00

Relative To

Selects the marker that the selected marker is relative to (*its reference marker*).

Key Path	Marker, Properties
Mode	BASIC, PNOISE, WCDMA, C2K, GSM, WIMAXOFDMA, TDSCDMA, 1XEVD0, DVB, DTMB, ISDBT, CMMB, LTE, LTETDD, DCATV, WLAN,,LTEATDD, LTEAFDD
Remote Command	:CALCulate:WAVEform:MARKer[1] 2 ... 12:REFerence <integer> :CALCulate:WAVEform:MARKer[1] 2 ... 12:REFerence?
Example	CALC:WAV:MARK:REF 8 CALC:WAV:MARK:REF?
Notes	A marker cannot be relative to itself so that choice is grayed out, and if sent from SCPI generates error -221: "Settings conflict; marker cannot be relative to itself." When queried a single value is returned (the specified marker numbers relative marker). You must be in a mode that includes the Waveform measurement to use this command. Use INSTRument:SElect to set the mode.
Preset	2 3 4 5 6 7 8 9 10 11 12 1
State Saved	Saved in instrument state.
Min	1
Max	12
Initial S/W Revision	Prior to A.02.00
Modified at S/W Revision	A.03.00

Marker Trace

Assigns the specified marker to the designated trace.

Key Path	Marker
Mode	BASIC, PNOISE, WCDMA, C2K, GSM, WIMAXOFDMA, TDSCDMA, 1XEVD0, DVB, DTMB, ISDBT, CMMB, LTE, LTETDD, DCATV, WLAN,,LTEATDD, LTEAFDD
Remote Command	:CALCulate:WAVeform:MARKer[1] 2 ... 12:TRACe RFENvelope I Q IQ :CALCulate:WAVeform:MARKer[1] 2 ... 12:TRACe?
Example	CALC:WAV:MARK:TRAC RFEN CALC:WAV:MARK:TRAC?
Notes	Assigns the specified marker to the designated trace. The IQ selection is for backward compatibility purposes. It is recommended that the users use the I and/or Q selection instead. You must be in a mode that includes the Waveform measurement to use this command. Use INSTRument:SElect to set the mode.
Preset	RFEN
State Saved	Saved in instrument state.
Range	RF Envelope I Q IQ
Initial S/W Revision	Prior to A.02.00
Modified at S/W Revision	A.03.00

Couple Markers

Toggles the state of the markers to be coupled On or Off. When this function is true (On), moving any marker causes an equal X-axis movement of every other marker which is not Off. "Equal X-axis movement" refers to the difference between each marker's X-Axis value (in the fundamental x-axis units of the trace that marker is on) and the X-Axis value of the marker being moved (in the same fundamental x-axis units) are preserved.

Key Path	Marker
Mode	BASIC, PNOISE, WCDMA, C2K, GSM, WIMAXOFDMA, TDSCDMA, 1XEVD0, DVB, DTMB, ISDBT, CMMB, LTE, LTETDD, DCATV, WLAN,,LTEATDD, LTEAFDD
Remote Command	:CALCulate:WAVeform:MARKer:COUPle[:STATe] ON OFF 1 0 :CALCulate:WAVeform:MARKer:COUPle[:STATe]?
Example	CALC:WAV:MARK:COUP ON CALC:WAV:MARK:COUP ON
Notes	You must be in a mode that includes the Waveform measurement to use this command. Use INSTRument:SElect to set the mode.
Preset	OFF

State Saved	Saved in instrument state.
Range	On Off
Initial S/W Revision	Prior to A.02.00
Modified at S/W Revision	A.03.00

All Markers Off

Turns off all markers.

Key Path	Marker
Mode	BASIC, PNOISE, WCDMA, C2K, GSM, WIMAXOFDMA, TDSCDMA, 1XEVD0, DVB, DTMB, ISDBT, CMMB, LTE, LTETDD, DCATV, WLAN,LTEATDD, LTEAFDD
Remote Command	:CALCulate:WAVeform:MARKer:AOFF
Example	CALC:WAV:MARK:AOFF
Notes	You must be in a mode that includes the Waveform measurement to use this command. Use INSTRument:SElect to set the mode.
Initial S/W Revision	Prior to A.02.00
Modified at S/W Revision	A.03.00

Marker X Axis Value (Remote Command Only)

Sets the marker X Axis value in the current marker X Axis Scale unit. It has no effect if the control mode is Off, but is the SCPI equivalent of entering an X value if the control mode is Normal or Delta.

Mode	BASIC, PNOISE, WCDMA, C2K, GSM, WIMAXOFDMA, TDSCDMA, 1XEVD0, DVB, DTMB, ISDBT, CMMB, LTE, LTETDD, DCATV, WLAN,,LTEATDD, LTEAFDD
Remote Command	:CALCulate:WAVeform:MARKer[1] 2 ... 12:X <time> :CALCulate:WAVeform:MARKer[1] 2 ... 12:X?
Example	CALC:WAV:MARK:X 50 ms CALC:WAV:MARK:X?
Notes	If no suffix is sent, uses the fundamental units for the current marker X Axis Scale. If a suffix is sent that does not match the current marker X Axis Scale unit, an error "Invalid suffix" is generated. If the specified marker is Fixed and a Marker Function is on, error -221 "Settings conflict; cannot adjust Fixed marker while Marker Function is on" is generated. The query returns the marker's absolute X Axis value if the control mode is Normal , or the offset from the marker's reference marker if the control mode is Delta . The query is returned in the fundamental units for the current marker X Axis scale: Hz for Frequency and Inverse Time , seconds for Period and Time . If the marker is Off the response is not a number. You must be in a mode that includes the Waveform measurement to use this command. Use INSTRument:SElect to set the mode.
Preset	0

Preset	After a preset, all markers are turned OFF, so Marker X Axis Value query returns a not a number (NAN).
State Saved	No
Min	(9.9E+37
Max	9.9E+37
Initial S/W Revision	Prior to A.02.00
Modified at S/W Revision	A.03.00

Marker X Axis Position (Remote Command Only)

Sets the marker X position in trace points. It has no effect if the control mode is Off, but is the SCPI equivalent of entering a value if the control mode is Normal or Delta. The entered value is immediately translated into the current X Axis Scale units for setting the value of the marker.

Mode	BASIC, PNOISE, WCDMA, C2K, GSM, WIMAXOFDMA, TDSCDMA, 1XEVD0, DVB, DTMB, ISDBT, CMMB, LTE, LTETDD, DCATV, WLAN,,LTEATDD, LTEAFDD
Remote Command	:CALCulate:WAVeform:MARKer[1] 2 ... 12:X:POSition <real> :CALCulate:WAVeform:MARKer[1] 2 ... 12:X:POSition?
Example	CALC:WAV:MARK:X:POS 500 CALC:WAV:MARK:X:POS?
Notes	The query returns the marker's absolute X Axis value in trace points if the control mode is Normal or the offset from the marker's reference marker in trace points if the control mode is Delta . The value is returned as a real number, not an integer, corresponding to the translation from X Axis Scale units to trace points. You must be in a mode that includes the Waveform measurement to use this command. Use INSTRument:SElect to set the mode.
Preset	0
Preset	After a preset, all markers are turned OFF, so Marker X Axis Value query returns a not a number (NAN).
State Saved	No
Min	(9.9E+37
Max	9.9E+37
Initial S/W Revision	Prior to A.02.00
Modified at S/W Revision	A.03.00

Marker Y Axis Value (Remote Command Only)

Queries the marker Y Axis value in the current marker Y Axis unit.

Mode	BASIC, PNOISE, WCDMA, C2K, GSM, WIMAXOFDMA, TDSCDMA, 1XEVD0, DVB, DTMB, ISDBT, CMMB, LTE, LTETDD, DCATV, WLAN,,LTEATDD, LTEAFDD
------	---

Remote Command	:CALCulate:WAVeform:MARKer[1] 2 ... 12:Y?
Example	CALC:WAV:MARK11:Y?
Notes	<p>When the marker is on, IQ waveform returns I and Q values.</p> <p>Case #1 - Trace RF, I or Q: returns a single double value.</p> <p>>:CALC:WAV:MARK1:Y? -2.402406506109E+001</p> <p>Case #2 - Trace IQ: returns a double array of two values, the first is I, and the second is Q.</p> <p>>:CALC:WAV:MARK1:Y? -3.006944493834E-003,+9.9870666467354E-004</p> <p>The IQ selection is for backward compatibility purposes. It is recommended that the users use the I and/or Q selection instead.</p> <p>You must be in a mode that includes the Waveform measurement to use this command. Use INSTRument:SElect to set the mode.</p>
Preset	Result dependent on the marker setup and signal source.
State Saved	No
Backwards Compatibility SCPI	:CALCulate:WAVeform:MARKer[1] 2 ... 12:FUNCTion:RESult?
Initial S/W Revision	Prior to A.02.00
Modified at S/W Revision	A.03.00

Marker ->

There is no 'Marker ->' functionality supported in Waveform measurements. The front-panel key displays a blank menu when pressed.

Key Path	Front-panel key
Initial S/W Revision	Prior to A.02.00

Marker Function

Accesses a menu of marker functions that perform post-processing operations on markers based on the measurement specifications. Marker functions are distinct from measurement functions, which automatically perform complex sequences of setup, data acquisition, and display operations in order to measure specified signal characteristics. Marker Functions are specified for each individual marker and may be turned on individually for each marker.

The Marker Function menu controls which marker functions are turned on and allows you to adjust the setup parameters for each function. These parameters include the following, but only one parameter can be assigned to a given marker:

- Marker Noise
- BandInterval Power
- Band/Interval Density
- Marker Function Off

Key Path	Front-panel key
Initial S/W Revision	Prior to A.02.00

Select Marker

Displays 12 markers available for selection.

Key Path	Marker
Initial S/W Revision	Prior to A.02.00

Marker Function Type

Sets the marker control function type to, Marker Noise, Band/Interval Power, Band Interval Density, or Marker Function Off

Key Path	Marker Function
Mode	BASIC, PNOISE, WCDMA, C2K, GSM, WIMAXOFDMA, TDSCDMA, 1XEVD0, DVB, DTMB, ISDBT, CMMB, LTE, LTETDD, DCATV, WLAN,,LTEATDD, LTEAFDD
Remote Command	:CALCulate:WAVeform:MARKer[1] 2 ... 12:FUNctIon BPOwer BDENsity OFF :CALCulate:WAVeform:MARKer[1] 2 ... 12:FUNctIon?
Example	CALC:WAV:MARK:FUNC BPOW CALC:WAV:MARK:FUNC?
Notes	You must be in a mode that includes the Waveform measurement to use this command. Use INSTRument:SElect to set the mode.
Preset	OFF

State Saved	Saved in instrument state.
Range	Band/Interval Power Band Interval Density Marker Function Off
Initial S/W Revision	Prior to A.02.00
Modified at S/W Revision	A.03.00

Band Adjust

Accesses a menu that enables you to set the frequency span width and the left and right edge, or time values, for the band or interval of the selected marker.

Key Path	Marker Function
Initial S/W Revision	Prior to A.02.00

Band/Interval Span for Time Domain

Sets the width of the frequency span for the selected marker.

Key Path	Marker Function
Mode	BASIC, PNOISE, WCDMA, C2K, GSM, WIMAXOFDMA, TDSCDMA, 1XEVD0, DVB, DTMB, ISDBT, CMMB, LTE, LTETDD, DCATV, WLAN,LTEATDD, LTEAFDD
Remote Command	:CALCulate:WAVEform:MARKer[1] 2 ... 12:FUNCTION:BAND:SPAN <time> :CALCulate:WAVEform:MARKer[1] 2 ... 12:FUNCTION:BAND:SPAN?
Example	CALC:WAV:MARK:FUNC:BAND:SPAN 20 ms CALC:WAV:MARK:FUNC:BAND:SPAN?
Notes	You must be in a mode that includes the Waveform measurement to use this command. Use INSTRUMENT:SELECT to set the mode.
Couplings	Changing the Band/Interval Span necessarily changes the Band/Interval Left and Band/Interval Right values
Preset	0
Preset	10% of Meas Time
State Saved	Saved in instrument state.
Min	0
Max	100 s
Backwards Compatibility SCPI	:CALCulate:WAVEform:MARKer[1] 2 ... 4:X:SPAN
Initial S/W Revision	Prior to A.02.00
Modified at S/W Revision	A.03.00

Band/Interval Left for Time Domain

Sets the left edge frequency or time value for the band of the selected marker.

Key Path	Marker Function
Mode	BASIC, PNOISE, WCDMA, C2K, GSM, WIMAXOFDMA, TDSCDMA, 1XEVD0, DVB, DTMB, ISDBT, CMMB, LTE, LTETDD, DCATV, WLAN,,LTEATDD, LTEAFDD
Remote Command	:CALCulate:WAVeform:MARKer[1] 2 ... 12:FUNction:BAND:LEFT <time> :CALCulate:WAVeform:MARKer[1] 2 ... 12:FUNction:BAND:LEFT?
Example	CALC:WAV:MARK12:FUNC:BAND:LEFT 1 s CALC:WAV:MARK12:FUNC:BAND:LEFT?
Notes	You must be in a mode that includes the Waveform measurement to use this command. Use INSTRument:SElect to set the mode.
Couplings	Changing the Band/Interval Left necessarily changes the Band/Interval Span and Band/Interval Right values
Preset	0
Preset	5% of Meas Time
State Saved	Saved in instrument state.
Min	0
Max	100 s
Initial S/W Revision	Prior to A.02.00
Modified at S/W Revision	A.03.00

Band/Interval Right for Time Domain

Sets the right edge frequency or time value for the band of the selected marker.

Key Path	Marker Function
Mode	BASIC, PNOISE, WCDMA, C2K, GSM, WIMAXOFDMA, TDSCDMA, 1XEVD0, DVB, DTMB, ISDBT, CMMB, LTE, LTETDD, DCATV, WLAN,,LTEATDD, LTEAFDD
Remote Command	:CALCulate:WAVeform:MARKer[1] 2 ... 12:FUNction:BAND:RIGHT <time> :CALCulate:WAVeform:MARKer[1] 2 ... 12:FUNction:BAND:RIGHT?
Example	CALC:WAV:MARK12:FUNC:BAND:RIGH 1 s CALC:WAV:MARK12:FUNC:BAND:RIGH?
Notes	You must be in a mode that includes the Waveform measurement to use this command. Use INSTRument:SElect to set the mode.
Couplings	Changing the Band/Interval Left necessarily changes the Band/Interval Span and Band/Interval Right values
Preset	0
Preset	5% of Meas Time
State Saved	Saved in instrument state.

9 Waveform Measurement
Marker Function

Min	0
Max	100 s
Initial S/W Revision	Prior to A.02.00
Modified at S/W Revision	A.03.00

Meas

The information in this section is common to all measurements. For key and remote command information for a specific measurement, refer to the section that describes the measurement of interest.

Measurements available under the Meas key are specific to the current Mode.

When viewing Help for measurements, note the following:

NOTE

Operation for some keys differs between measurements. The information displayed in Help pertains to the current measurement. To see how a key operates in a different measurement, exit Help (press the Cancel Esc key), select the measurement, then reenter Help (press the Help key) and press that key.

Key Path	Front-panel key
Initial S/W Revision	Prior to A.02.00

Remote Measurement Functions

This section contains the following topics:

"Measurement Group of Commands" on page 558

"Current Measurement Query (Remote Command Only)" on page 560

"Limit Test Current Results (Remote Command Only)" on page 560

"Data Query (Remote Command Only)" on page 560

"Calculate/Compress Trace Data Query (Remote Command Only)" on page 561

"Calculate Peaks of Trace Data (Remote Command Only)" on page 566

Hardware-Accelerated Fast Power Measurement (Remote Command Only)

"Format Data: Numeric Data (Remote Command Only)" on page 567

"Format Data: Byte Order (Remote Command Only)" on page 568

Initial S/W Revision	Prior to A.02.00
----------------------	------------------

Measurement Group of Commands

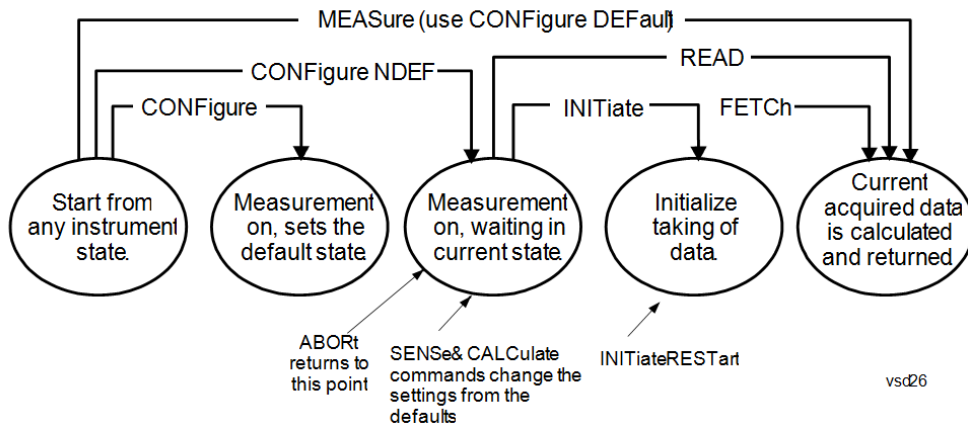

Measure Commands:

:MEASure:<measurement>[n]?

This is a fast single-command way to make a measurement using the factory default instrument settings. These are the settings and units that conform to the Mode Setup settings (e.g. radio standard) that you have currently selected.

- Stops the current measurement (if any) and sets up the instrument for the specified measurement using the factory defaults
- Initiates the data acquisition for the measurement
- Blocks other SCPI communication, waiting until the measurement is complete before returning results.
- If the function does averaging, it is turned on and the number of averages is set to 10.
- After the data is valid it returns the scalar results, or the trace data, for the specified measurement. The type of data returned may be defined by an [n] value that is sent with the command.
- The scalar measurement results will be returned if the optional [n] value is not included, or is set to 1. If the [n] value is set to a value other than 1, the selected trace data results will be returned. See each command for details of what types of scalar results or trace data results are available.
- ASCII is the default format for the data output. (Older versions of Spectrum Analysis and Phase Noise mode measurements only use ASCII.) The binary data formats should be used for handling large blocks of data since they are smaller and faster than the ASCII format. Refer to the FORMat:DATA command for more information.

If you need to change some of the measurement parameters from the factory default settings you can set up the measurement with the CONFigure command. Use the commands in the SENSE:<measurement> and CALCulate:<measurement> subsystems to change the settings. Then you can use the READ? command to initiate the measurement and query the results.

If you need to repeatedly make a given measurement with settings other than the factory defaults, you can use the commands in the SENSE:<measurement> and CALCulate:<measurement> subsystems to set up the measurement. Then use the READ? command to initiate the measurement and query results.

Measurement settings persist if you initiate a different measurement and then return to a previous one. Use READ:<measurement>? if you want to use those persistent settings. If you want to go back to the default settings, use MEASure:<measurement>?.

Configure Commands:

:CONFigure:<measurement>

This command stops the current measurement (if any) and sets up the instrument for the specified measurement using

the factory default instrument settings. It does not initiate the taking of measurement data unless INIT:CONTInuous is ON. If you change any measurement settings after using the CONFigure command, the READ command can be used to initiate a measurement without changing the settings back to their defaults.

In the Swept SA measurement in Spectrum Analyzer mode the CONFigure command also turns the averaging function on and sets the number of averages to 10 for all measurements.

:CONFigure: <measurement>: NDEFault stops the current measurement and changes to the specified measurement. It does not change the settings to the defaults. It does not initiate the taking of measurement data unless INIT:CONTInuous is ON.

The CONFigure? query returns the current measurement name.

The CONFigure:CATalog? query returns a quoted string of all licensed measurement names in the current mode. For example, "SAN, CHP, OBW, ACP, PST, TXP, SPUR, SEM, LIST".

Fetch Commands:

:FETCh:<measurement>[n]?

This command puts selected data from the most recent measurement into the output buffer. Use FETCh if you have already made a good measurement and you want to return several types of data (different [n] values, for example, both scalars and trace data) from a single measurement. FETCh saves you the time of re-making the measurement. You can only FETCh results from the measurement that is currently active, it will not change to a different measurement. An error message is reported if a measurement other than the current one is specified.

If you need to get new measurement data, use the READ command, which is equivalent to an INITiate followed by a FETCh.

The scalar measurement results will be returned if the optional [n] value is not included, or is set to 1. If the [n] value is set to a value other than 1, the selected trace data results will be returned. See each command for details of what types of scalar results or trace data results are available. The binary data formats should be used for handling large blocks of data since they are smaller and transfer faster than the ASCII format. (FORMat:DATA)

FETCh may be used to return results other than those specified with the original READ or MEASure command that you sent.

INITiate Commands:

:INITiate:<measurement>

This command is not available for measurements in all the instrument modes:

- Initiates a trigger cycle for the specified measurement, but does not output any data. You must then use the FETCh<meas> command to return data. If a measurement other than the current one is specified, the instrument will switch to that measurement and then initiate it.
 - For example, suppose you have previously initiated the ACP measurement, but now you are running the channel power measurement. If you send INIT:ACP? it will change from channel power to ACP and will initiate an ACP measurement.
 - Does not change any of the measurement settings. For example, if you have previously started the ACP measurement and you send INIT:ACP? it will initiate a new ACP measurement using the same instrument settings as the last time ACP was run.
 - If your selected measurement is currently active (in the idle state) it triggers the measurement, assuming the trigger conditions are met. Then it completes one trigger cycle. Depending upon the measurement and the number of averages, there may be multiple data acquisitions, with multiple trigger events, for one full trigger cycle. It also holds off additional commands on GPIB until the acquisition is complete.
-

READ Commands:

:READ:<measurement>[n]?

- Does not preset the measurement to the factory default settings. For example, if you have previously initiated the ACP
-

measurement and you send READ:ACP? it will initiate a new measurement using the same instrument settings.

- Initiates the measurement and puts valid data into the output buffer. If a measurement other than the current one is specified, the instrument will switch to that measurement before it initiates the measurement and returns results.
 - For example, suppose you have previously initiated the ACP measurement, but now you are running the channel power measurement. Then you send READ:ACP? It will change from channel power back to ACP and, using the previous ACP settings, will initiate the measurement and return results.
 - Blocks other SCPI communication, waiting until the measurement is complete before returning the results
 - If the optional [n] value is not included, or is set to 1, the scalar measurement results will be returned. If the [n] value is set to a value other than 1, the selected trace data results will be returned. See each command for details of what types of scalar results or trace data results are available. The binary data formats should be used when handling large blocks of data since they are smaller and faster than the ASCII format. (FORMat:DATA)
-

Initial S/W Revision	Prior to A.02.00
----------------------	------------------

Current Measurement Query (Remote Command Only)

This command returns the name of the measurement that is currently running.

Remote Command	:CONFigure?
-----------------------	-------------

Example	CONF?
----------------	-------

Initial S/W Revision	Prior to A.02.00
----------------------	------------------

Limit Test Current Results (Remote Command Only)

Queries the status of the current measurement limit testing. It returns a 0 if the measured results pass when compared with the current limits. It returns a 1 if the measured results fail any limit tests.

Remote Command	:CALCulate:CLIMits:FAIL?
-----------------------	--------------------------

Example	CALC:CLIM:FAIL? queries the current measurement to see if it fails the defined limits. Returns a 0 or 1: 0 it passes, 1 it fails.
----------------	--

Initial S/W Revision	Prior to A.02.00
----------------------	------------------

Data Query (Remote Command Only)

Returns the designated measurement data for the currently selected measurement and subopcode.

n = any valid subopcode for the current measurement. See the measurement command results table for your current measurement, for information about what data is returned for the subopcodes.

This command uses the data setting specified by the FORMat:BORDER and FORMat:DATA commands and can return real or ASCII data. (See the format command descriptions under Input/Output in the Analyzer Setup section.)

Remote Command	:CALCulate:DATA[n]?
Notes	The return trace depends on the measurement. In CALCulate:<meas>:DATA[n], n is any valid subopcode for the current measurement. It returns the same data as the FETCH:<measurement>? query where <measurement> is the current measurement.
Initial S/W Revision	Prior to A.02.00

Calculate/Compress Trace Data Query (Remote Command Only)

Returns compressed data for the currently selected measurement and sub-opcode [n].

n = any valid sub-opcode for that measurement. See the MEASure:<measurement>? command description of your specific measurement for information on the data that can be returned.

The data is returned in the current Y Axis Unit of the analyzer. The command is used with a sub-opcode <n> (default=1) to specify the trace. With trace queries, it is best if the analyzer is not sweeping during the query. Therefore, it is generally advisable to be in Single Sweep, or Update=Off.

This command is used to compress or decimate a long trace to extract and return only the desired data. A typical example would be to acquire N frames of GSM data and return the mean power of the first burst in each frame. The command can also be used to identify the best curve fit for the data.

Remote Command	:CALCulate:DATA<n>:COMPRESS? BLOCK CFIT MAXimum MINimum MEAN DMEan RMS RMSCubed SAMPLE SDEVIation PPHase [,<soffset> [,<length>[,<roffset>[,<rlimit>]]]]
Example	To query the mean power of a set of GSM bursts: Supply a signal that is a set of GSM bursts. Select the IQ Waveform measurement (in IQ Analyzer Mode). Set the sweep time to acquire at least one burst. Set the triggers such that acquisition happens at a known position relative to a burst. Then query the mean burst levels using, CALC:DATA2:COMP? MEAN, 24e-6, 526e-6 (These parameter values correspond to GSM signals, where 526e-6 is the length of the burst in the slot and you just want 1 burst.)
Notes	The command supports 5 parameters. Note that the last 4 (<soffset>, <length>, <roffset>, <rlimit>) are optional. But these optional parameters must be entered in the specified order. For example, if you want to specify <length>, then you must also specify <soffset>. See details below for a definition of each of these parameters. This command uses the data in the format specified by FORMat:DATA, returning either binary or ASCII data.
Initial S/W Revision	Prior to A.02.00

- BLOCK or block data - returns all the data points from the region of the trace data that you specify. For example, it could be used to return the data points of an input signal over several timeslots, excluding the portions of the trace data that you do not want. (This is x,y pairs for trace data and I,Q pairs for complex data.)

- CFIT or curve fit - applies curve fitting routines to the data. <soffset> and <length> are required to define the data that you want. <roffset> is an optional parameter for the desired order of the curve equation. The query will return the following values: the x-offset (in seconds) and the curve coefficients ((order + 1) values).

MIN, MAX, MEAN, DME, RMS, RMSC, SAMP, SDEV and PPH return one data value for each specified region (or <length>) of trace data, for as many regions as possible until you run out of trace data (using <roffset> to specify regions). Or they return the number of regions you specify (using <rlimit>) ignoring any data beyond that.

- MINimum - returns the minimum data point (y value) for the specified region(s) of trace data. For I/Q trace data, the minimum magnitude of the I/Q pairs is returned.
- MAXimum - returns the maximum data point (y value) for the specified region(s) of trace data. For I/Q trace data, the maximum magnitude of the I/Q pairs is returned.
- MEAN - returns a single value that is the arithmetic mean of the data point values (in dB/ dBm) for the specified region(s) of trace data. For I/Q trace data, the mean of the magnitudes of the I/Q pairs is returned. See the following equations.

NOTE If the original trace data is in dB, this function returns the arithmetic mean of those log values, not log of the mean power which is a more useful value. The mean of the log is the better measurement technique when measuring CW signals in the presence of noise. The mean of the power, expressed in dB, is useful in power measurements such as Channel Power. To achieve the mean of the power, use the RMS option.

Equation 1

Mean Value of Data Points for Specified Region(s)

$$MEAN = \frac{1}{n} \sum_{X_i \in \text{region}(s)} X_i$$

where X_i is a data point value, and n is the number of data points in the specified region(s).

Equation 2

Mean Value of I/Q Data Pairs for Specified Region(s)

$$MEAN = \frac{1}{n} \sum_{X_i \in \text{region}(s)} |X_i|$$

where $|X_i|$ is the magnitude of an I/Q pair, and n is the number of I/Q pairs in the specified region(s).

- DMEan - returns a single value that is the mean power (in dB/ dBm) of the data point values for the specified region(s) of trace data. See the following equation:

Equation 3

DMEan Value of Data Points for Specified Region(s)

$$\text{DME} = 10 \times \log_{10} \left(\frac{1}{n} \sum_{X_i \in \text{region}(s)} 10^{\frac{X_i}{10}} \right)$$

- RMS - returns a single value that is the average power on a root-mean-squared voltage scale (arithmetic rms) of the data point values for the specified region(s) of trace data. See the following equation.

NOTE For I/Q trace data, the rms of the magnitudes of the I/Q pairs is returned. See the following equation. This function is very useful for I/Q trace data. However, if the original trace data is in dB, this function returns the rms of the log values which is not usually needed.

Equation 4

RMS Value of Data Points for Specified Region(s)

$$\text{RMS} = \sqrt{\frac{1}{n} \sum_{X_i \in \text{region}(s)} X_i^2}$$

where X_i is a data point value, and n is the number of data points in the specified region(s).

Equation 5

RMS Value of I/Q Data Pairs for Specified Region(s)

$$\text{RMS} = \sqrt{\frac{1}{n} \sum_{X_i \in \text{region}(s)} X_i X_i^*}$$

where X_i is the complex value representation of an I/Q pair, X_i^* its conjugate complex number, and n is the number of I/Q pairs in the specified region(s).

Once you have the rms value for a region of trace data (linear or I/Q), you may want to calculate the mean power. You must convert this rms value (peak volts) to power in dBm:

$$10 \times \log[10 \times (\text{rms value})^2]$$

- SAMPlE - returns the first data value (x,y pair) for the specified region(s) of trace data. For I/Q trace data, the first I/Q pair is returned.
- SDEViation - returns a single value that is the arithmetic standard deviation for the data point values for the specified region(s) of trace data. See the following equation.
- For I/Q trace data, the standard deviation of the magnitudes of the I/Q pairs is returned. See the following equation.

Equation 6

Standard Deviation of Data Point Values for Specified Region(s)

$$\text{SDEV} = \sqrt{\frac{1}{n} \sum_{X_i \in \text{region}(s)} (X_i - \bar{X})^2}$$

where X_i is a data point value, \bar{X} is the arithmetic mean of the data point values for the specified region (s), and n is the number of data points in the specified region(s).

$$\text{SDEV} = \sqrt{\frac{1}{n} \sum_{X_i \in \text{region}(s)} (|X_i| - \bar{X})^2}$$

where $|X_i|$ is the magnitude of an I/Q pair, \bar{X} is the mean of the magnitudes for the specified region(s), and n is the number of data points in the specified region(s).

- PPHase - returns the x,y pairs of both rms power (dBm) and arithmetic mean phase (radian) for every specified region and frequency offset (Hz). The number of pairs is defined by the specified number of regions. This parameter can be used for I/Q vector ($n=0$) in Waveform (time domain) measurement and all parameters are specified by data point in PPHase.

The rms power of the specified region may be expressed as:

$$\text{Power} = 10 \times \log [10 \times (\text{RMS I/Q value})] + 10.$$

The RMS I/Q value (peak volts) is:

$$\sqrt{\frac{1}{n} \sum_{X_i \in \text{region}} X_i X_i^*}$$

where X_i is the complex value representation of an I/Q pair, X_i^* its conjugate complex number, and n is the number of I/Q pairs in the specified region.

The arithmetic mean phase of the specified region may be expressed as:

$$\frac{1}{n} \sum_{Y_i \in \text{region}} Y_i$$

where Y_i is the unwrapped phase of I/Q pair with applying frequency correction and n is the number of I/Q pairs in the specified region.

The frequency correction is made by the frequency offset calculated by the arithmetic mean of every specified region's frequency offset. Each frequency offset is calculated by the least square method against the unwrapped phase of I/Q pair.

Sample Trace Data - Constant Envelope

(See below for explanation of variables.)

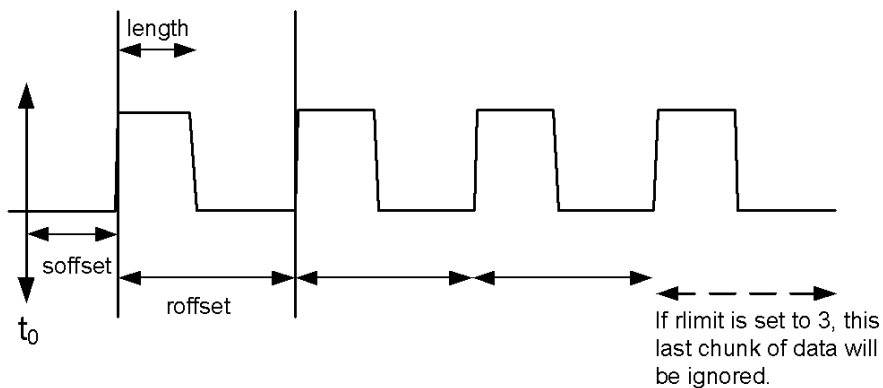

Sample Trace Data - Not Constant Envelope

(See below for explanation of variables.)

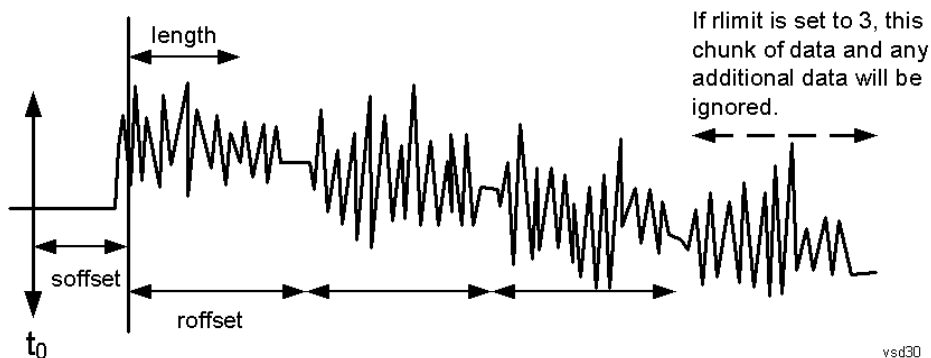

<soffset> - start offset is an optional real number. (It is in seconds for time-domain traces, and is a dimensionless index 0 to Npoints - 1, for frequency-domain traces). It specifies the amount of data at the beginning of the trace that will be ignored before the decimation process starts. It is the time or frequency change from the start of the trace to the point where you want to start using the data. The default value is zero.

<length> - is an optional real number. (It is in seconds for time-domain traces, and is a dimensionless index 0 to Npoints - 1, for frequency-domain traces). It defines how much data will be compressed into one value. This parameter has a default value equal to the current trace length.

<roffset> - repeat offset is an optional real number. (It is in seconds for time-domain traces, and is a dimensionless index 0 to Npoints - 1, for frequency-domain traces). It defines the beginning of the next field of trace elements to be compressed. This is relative to the beginning of the previous field. This parameter has a default value equal to the <length> variable. Note that this parameter is used for a completely different purpose when curve fitting (see CFIT above).

<rlimit> - repeat limit is an optional integer. It specifies the number of data items that you want returned. It will ignore any additional items beyond that number. You can use the Start offset and the Repeat limit to pick out exactly what part of the data you want to use. The default value is all the data.

Calculate Peaks of Trace Data (Remote Command Only)

Returns a list of all the peaks for the currently selected measurement and sub-opcode [n]. The peaks must meet the requirements of the peak threshold and excursion values.

n = any valid sub-opcode for the current measurement. See the MEASure:<measurement> command description of your specific measurement for information on the data that can be returned.

The command can only be used with specific sub-opcodes with measurement results that are trace data. Both real and complex traces can be searched, but complex traces are converted to magnitude in dBm. In many measurements the sub-opcode n=0, is the raw trace data which cannot be searched for peaks. And Sub-opcode n=1, is often calculated results values which also cannot be searched for peaks.

This command uses the data setting specified by the FORMat:BORDER and FORMat:DATA commands and can return real or ASCII data. If the format is set to INT,32, it returns REAL,32 data.

The command has four types of parameters:

- Threshold (in dBm)
- Excursion (in dB)
- Sorting order (amplitude, frequency, time)
- Optional in some measurements: Display line use (all, > display line, < display line)

Remote Command	<p>For Swept SA measurement:</p> <pre>:CALCulate:DATA[1] 2 ... 6:PEAKs? <threshold>,<excursion>[,AMPLitude FREQuency TIME[,ALL GTDLine LTDLine]]</pre> <p>For most other measurements:</p> <pre>:CALCulate:DATA[1] 2 ... 6:PEAKs? <threshold>,<excursion>[,AMPLitude FREQuency TIME]</pre>
-----------------------	--

Example	<p>Example for Swept SA measurement in Spectrum Analyzer Mode:</p> <p>CALC:DATA4:PEAK? -40, 10, FREQ, GTDL This will identify the peaks of trace 4 that are above -40 dBm, with excursions of at least 10 dB. The peaks are returned in order of increasing frequency, starting with the lowest frequency. Only the peaks that are above the display line are returned.</p> <p>Query Results 1:</p> <p>With FORMat:DATA REAL, 32 selected, it returns a list of floating-point numbers. The first value in the list is the number of peak points that are in the following list. A peak point consists of two values: a peak amplitude followed by its corresponding frequency (or time).</p> <p>If no peaks are found the peak list will consist of only the number of peaks, (0).</p>
----------------	---

Notes	<p><n> - is the trace that will be used</p> <p><threshold> - is the level below which trace data peaks are ignored. Note that the threshold value is required and is always used as a peak criterion. To effectively disable the threshold criterion for this command, provide a substantially low threshold value such as -200 dBm. Also note that the threshold value used in this command is independent of and has no effect on the threshold value stored under the Peak Criteria menu.</p> <p><excursion> - is the minimum amplitude variation (rise and fall) required for a signal to be identified as peak. Note that the excursion value is required and is always used as a peak criterion. To effectively disable the excursion criterion for this command, provide the minimum value of 0.0 dB. Also note that the excursion value used in this command is independent of and has no effect on the</p>
--------------	---

excursion value stored under the Peak Criteria menu.

Values must be provided for threshold and excursion. The sorting and display line parameters are optional (defaults are AMPLitude and ALL).

Note that there is always a Y-axis value for the display line, regardless of whether the display line state is on or off. It is the current Y-axis value of the display line which is used by this command to determine whether a peak should be reported

Sorting order:

AMPLitude - lists the peaks in order of descending amplitude, with the highest peak first (default if optional parameter not sent)

FREQUency - lists the peaks in order of occurrence, left to right across the x-axis.

TIME - lists the peaks in order of occurrence, left to right across the x-axis.

Peaks vs. Display Line:

ALL - lists all of the peaks found (default if optional parameter not sent).

GTDLine (greater than display line) - lists all of the peaks found above the display line.

LTDLine (less than display line) - lists all of the peaks found below the display line.

Initial S/W Revision Prior to A.02.00

Format Data: Numeric Data (Remote Command Only)

This command specifies the format of the trace data input and output. It specifies the formats used for trace data during data transfer across any remote port. It affects only the data format for setting and querying trace data for the :TRACe[:DATA], TRACe[:DATA]?, :CALCulate:DATA[n]? and FETCh:SANalyzer [n]? commands and queries.

Remote Command	:FORMat[:TRACe][:DATA] ASCii INTeger,32 REAL,32 REAL,64 :FORMat[:TRACe][:DATA]?
Notes	The query response is: ASCii: ASC,8 REAL,32: REAL,32 REAL,64: REAL,64 INTeger,32: INT,32 When the numeric data format is REAL or ASCii, data is output in the current Y Axis unit. When the data format is INTeger, data is output in units of m dBm (.001 dBm). The INT,32 format returns binary 32-bit integer values in internal units (m dBm), in a definite length block.
Dependencies	Sending a data format spec with an invalid number (for example, INT,48) generates no error. The analyzer simply uses the default (8 for ASCii, 32 for INTeger, 32 for REAL). Sending data to the analyzer which does not conform to the current FORMat specified, results in an error. Sending ASCII data when a definite block is expected generates message -161 "Invalid Block Data" and sending a definite block when ASCII data is expected generates message -121 "Invalid Character in Number".
Preset	ASCii
Backwards Compatibility Notes	Note that the INT,32 format is only applicable to the command, TRACe:DATA. This preserves backwards compatibility for the Swept SA measurement. For all other commands/queries which honor FORMat:DATA, if INT,32 is sent the analyzer will behave as though it were set to REAL,32.

Initial S/W Revision	Prior to A.02.00
----------------------	------------------

The specs for each output type follow:

ASCIi - Amplitude values are in ASCII, in the current Y Axis Unit, one ASCII character per digit, values separated by commas, each value in the form:

SX.YYYYYEsZZ

Where:

S = sign (+ or -)

X = one digit to left of decimal point

Y = 5 digits to right of decimal point

E = E, exponent header

s = sign of exponent (+ or -)

ZZ = two digit exponent

REAL,32 - Binary 32-bit real values in the current Y Axis Unit, in a definite length block.

REAL,64 - Binary 64-bit real values in the current Y Axis Unit, in a definite length block.

Format Data: Byte Order (Remote Command Only)

This command selects the binary data byte order for data transfer and other queries. It controls whether binary data is transferred in normal or swapped mode. This command affects only the byte order for setting and querying trace data for the :TRACe[:DATA], TRACe[:DATA]? , :CALCulate:DATA[n]? and FETCh:SANalyzer[n]? commands and queries.

By definition any command that says it uses FORMat:DATA uses any format supported by FORMat:DATA.

The NORMal order is a byte sequence that begins with the most significant byte (MSB) first, and ends with the least significant byte (LSB) last in the sequence: 1|2|3|4. SWAPped order is when the byte sequence begins with the LSB first, and ends with the MSB last in the sequence: 4|3|2|1.

Remote Command	:FORMat:BORDer NORMal SWAPped :FORMat:BORDer?
-----------------------	--

Preset	NORMal
---------------	--------

Initial S/W Revision	Prior to A.02.00
-----------------------------	------------------

Meas Setup

Displays the setup menu keys that enable you to control the parameters for the current measurement.

Key Path	Front-panel key
Initial S/W Revision	Prior to A.02.00

Average/Hold Num

Sets the number of sweeps (average counts) that are averaged. After the specified number of sweeps, the averaging mode (terminal control) setting determines the averaging action.

Key Path	Meas Setup
Mode	BASIC, PNOISE, WCDMA, C2K, GSM, WIMAXOFDMA, TDSCDMA, 1XEVD0, DVB, DTMB, ISDBT, CMMB, LTE, LTETDD, DCATV, WLAN, MSR, LTEATDD, LTEAFDD
Remote Command	[:SENSe]:WAVeform:AVERAge:COUNT <integer> [:SENSe]:WAVeform:AVERAge:COUNT? [:SENSe]:WAVeform:AVERAge[:STATe] OFF ON 0 1 [:SENSe]:WAVeform:AVERAge[:STATe]?
Example	WAV:AVER:COUN 1001 WAV:AVER:COUN? WAV:AVER ON WAV:AVER?
Notes	You must be in a mode that includes the Waveform measurement to use this command. Use INSTRument:SElect to set the mode.
Preset	10 OFF
State Saved	Saved in instrument state.
Min	1
Max	20001
Initial S/W Revision	Prior to A.02.00
Modified at S/W Revision	A.03.00

Avg Mode

Enables you to set the averaging mode.

- When set to Exponential (Exp) the measurement averaging continues using the specified number of averages to compute each averaged value. The average is displayed at the end of each sweep.
- When set to Repeat, the measurement resets the average counter each time the specified number of averages is reached.

Key Path	Meas Setup
Mode	BASIC, PNOISE, WCDMA, C2K, GSM, WIMAXOFDMA, TDSCDMA, 1XEVDO, DVB, DTMB, ISDBT, CMMB, LTE, LTETDD, DCATV, WLAN, MSR,LTEATDD, LTEAFDD
Remote Command	[:SENSe] :WAVeform:AVErAge:TCONtrol EXPonential REPeat [:SENSe] :WAVeform:AVErAge:TCONtrol?
Example	WAV:AVER:TCON REP WAV:AVER:TCON?
Notes	You must be in a mode that includes the Waveform measurement to use this command. Use INSTRUMENT:SElect to set the mode.
Preset	EXPonential
State Saved	Saved in instrument state.
Range	Exp Repeat
Initial S/W Revision	Prior to A.02.00
Modified at S/W Revision	A.03.00

Avg Type

Selects the type of averaging.

Key Path	Meas Setup
Mode	BASIC, PNOISE, WCDMA, C2K, GSM, WIMAXOFDMA, TDSCDMA, 1XEVDO, DVB, DTMB, ISDBT, CMMB, LTE, LTETDD, DCATV, WLAN, MSR,LTEATDD, LTEAFDD
Remote Command	[:SENSe] :WAVeform:AVErAge:TYPE LOG RMS SCALar [:SENSe] :WAVeform:AVErAge:TYPE?
Example	WAV:AVER:TYPE RMS WAV:AVER:TYPE?
Preset	RMS
State Saved	Saved in instrument state.
Range	Pwr Avg(RMS) Log-Pwr Avg(Video) Voltage Avg
Initial S/W Revision	Prior to A.02.00
Modified at S/W Revision	A.03.00

Avg Type Auto

When **Auto** is selected, the analyzer chooses the type of averaging. When one of the average types is selected manually, the analyzer uses that type regardless of other analyzer settings, and shows Man on the **Average Type** softkey.

Key Path	Meas Setup, Avg Type
Remote Command	[:SENSe] :WAVeform:AVERage:TYPE:AUTO [:STATe] ON OFF 1 0 [:SENSe] :WAVeform:AVERage:TYPE:AUTO [:STATe] ?
Example	WAV:AVER:TYPE:AUTO 0 WAV:AVER:TYPE:AUTO?
Couplings	Auto selects Power (RMS) averaging if a Marker Function (Marker Noise, Band/Intvl Power) is on.
Preset	ON
State Saved	Saved in instrument state.
Range	Auto Man
Modified at S/W Revision	A.14.00

Meas Time

Sets how long the measurement is performed. X Scale only changes the representation of the display.

Key Path	Meas Setup
Mode	BASIC, PNOISE, WCDMA, C2K, GSM, WIMAXOFDMA, TDSCDMA, 1XEVD0, DVB, DTMB, ISDBT, CMMB, LTE, LTEATDD, DCATV, WLAN, MSR,LTEATDD, LTEAFDD
Remote Command	[:SENSe] :WAVeform:SWEep:TIME <time> [:SENSe] :WAVeform:SWEep:TIME?
Example	WAV:SWE:TIME 50 ms WAV:SWE:TIME?
Notes	Specifies and returns how long the measurement is performed. It is the time record length of the measurement waveform. The Max time may be reduced when the sample frequency is high due to the memory limitation. You must be in a mode that includes the Waveform measurement to use this command. Use INSTRument:SElect to set the mode.
Preset	All except the following list: 2.000000 ms LTEAFDD, LTEATDD: 10 ms LTEATDD: 10 ms LTE: 10 ms
State Saved	Saved in instrument state.
Range	1.000 (s to 100.00 s
Min	1.000 us
Max	3200 s
Initial S/W Revision	Prior to A.02.00
Modified at S/W Revision	A.03.00, A.14.00

Sample Rate

Enables you to set an arbitrary sample rate for the acquired data to be processed.

Key Path	Meas Setup
Mode	BASIC
Remote Command	<code>[:SENSe] :WAVeform :SRATe <freq></code> <code>[:SENSe] :WAVeform :SRATe ?</code>
Example	WAV:SRAT 1.3636 MHz
Notes	Command and query available when Option DP2, B40, or wider IF Bandwidth option is installed. For other configuration, only query is available.
Couplings	The coupling between Sample Rate and IF BW depends on Physics implementation.
Preset	125.0 kHz
Min	12.5 Hz
Max	<ul style="list-style-type: none"> • (For Option DP2, B40 or wider IF Bandwidth option) • Digital IF 10 MHz path: 12.5 MHz • Digital IF 25 MHz path: 31.25 MHz • Digital IF 40 MHz path: 50 MHz • Option B85 85 MHz path: 106.25 MHz • Option B1A 125 MHz path: 156.25 MHz • Option B1X 140 MHz path: 175 MHz • Option B1Y 160 MHz path: 200 MHz • Option B2X 140 MHz path: 300 MHz • Option B5X 160 MHz path: 300 MHz • (For all other configuration) • 10 MHz path: 15 MHz • Option B25 25 MHz path: 45 MHz
Modified at S/W Revision	13.00

Meas Preset

Restores all the measurement parameters to their default values.

Key Path	Meas Setup
Mode	BASIC, PNOISE, WCDMA, C2K, GSM, WIMAXOFDMA, TDSCDMA, 1XEVD0, DVB, DTMB, ISDBT, CMMB, LTE, LTETDD, DCATV, WLAN, MSR, LTEATDD, LTEAFDD
Remote Command	<code>:CONFigure:WAVeform</code>
Example	CONF:WAV
Notes	Restore default values of all parameters. You must be in a mode that includes the Waveform measurement to use this command. Use INSTRument:SElect to set the mode.

Initial S/W Revision	Prior to A.02.00
Modified at S/W Revision	A.03.00

Sample Period (Aperture) Setting (Remote Command Only)

Returns the time between samples (sample period or aperture).

Mode	BASIC
Remote Command	[:SENSe] :WAVeform:APERture?
Example	WAV:APER?
Notes	Query only.
Couplings	Coupled to Sample Rate by the following equation. Sample Period = 1/(Sample Rate)
Preset	1/(Sample Rate Default)
Min	1/(Max Sample Rate)
Max	1/(Min Sample Rate)

Mode

See "[Mode](#)" on page 142

Mode Preset

Returns the active mode to a known state.

Mode Preset does the following for the currently active mode:

- Aborts the currently running measurement.
- Brings up the default menu for the mode, with no active function.
- Sets measurement Global settings to their preset values for the active mode only.
- Activates the default measurement.
- Brings up the default menu for the mode.
- Clears the input and output buffers.
- Sets Status Byte to 0.

Mode Preset does not:

- Cause a mode switch
- Affect mode persistent settings
- Affect system settings
- See "[How-To Preset](#)" on page 576 for more information.

Key Path	Front-panel key
Remote Command	:SYSTem:PRESet
Example	:SYST:PRES
Notes	*RST is preferred over :SYST:PRES for remote operation. *RST does a Mode Preset, as done by the :SYST:PRES command, and it sets the measurement mode to Single measurement rather than Continuous for optimal remote control throughput. Clears all pending OPC bits. The Status Byte is set to 0.
Couplings	A Mode Preset aborts the currently running measurement, activates the default measurement, and gets the mode to a consistent state with all of the default couplings set.
Backwards Compatibility Notes	In the X-Series, the legacy "Factory Preset" has been replaced with Mode Preset, which only presets the currently active mode, not the entire instrument. In the X-Series, the way to preset the entire instrument is by using System, Restore System Defaults All, which behaves essentially the same way as restore System Defaults does on ESA and PSA. There is also no "Preset Type" as there is on the PSA. There is a green Mode Preset front-panel key that does a Mode Preset and a white-with-green-letters User Preset front-panel key that does a User Preset. The old PRESet:TYPE command is ignored (without generating an error), and SYST:PRES without a parameter does a Mode Preset, which should cover most backward code compatibility issues. The settings and correction data under the Input/Output front-panel key (examples: Input Z Corr, Ext Amp Gain, etc.) are no longer part of any Mode, so they will not be preset by a Mode Preset. They are preset using Restore Input/Output Defaults, Restore System Defaults All. Note that because User Preset does a Recall State, and all of these settings are saved in State, they ARE recalled when using

	User Preset.
Initial S/W Revision	Prior to A.02.00

How-To Preset

The table below shows all possible presets, their corresponding SCPI commands and front-panel access (key paths). Instrument settings depend on the current measurement context. Some settings are local to the current measurement, some are global (common) across all the measurements in the current mode, and some are global to all the available modes. In a similar way, restoring the settings to their preset state can be done within the different contexts.

Auto Couple - is a measurement local key. It sets all Auto/Man parameter couplings in the measurement to Auto. Any Auto/Man selection that is local to other measurements in the mode will not be affected.

Meas Preset - is a measurement local key. Meas Preset resets all the variables local to the current measurement except the persistent ones.

Mode Preset - resets all the current mode's measurement local and measurement global variables except the persistent ones.

Restore Mode Defaults - resets ALL the Mode variables (and all the Meas global and Meas local variables), including the persistent ones.

Type Of Preset	SCPI Command	Front Panel Access
Auto Couple	:COUPle ALL	Auto Couple front-panel key
Meas Preset	:CONFigure:<Measurement>	Meas Setup Menu
Mode Preset	:SYSTem:PRESet	Mode Preset (green key)
Restore Mode Defaults	:INSTrument:DEFault	Mode Setup Menu
Restore All Mode Defaults	:SYSTem:DEFault MODEs	System Menu; Restore System Default Menu
*RST	*RST	not possible (Mode Preset with Single)
Restore Input/Output Defaults	:SYSTem:DEFault INPUt	System Menu; Restore System Default Menu
Restore Power On Defaults	:SYSTem:DEFault PON	System Menu; Restore System Default Menu
Restore Alignment Defaults	:SYSTem:DEFault ALIGn	System Menu; Restore System Default Menu
Restore Miscellaneous Defaults	:SYSTem:DEFault MISC	System Menu; Restore System Default Menu
Restore All System Defaults	:SYSTem:DEFault [ALL] :SYSTem:PRESet:PERsistent	System Menu; Restore System Default Menu
User Preset	:SYSTem:PRESet:USER	User Preset Menu
User Preset All Modes	:SYSTem:PRESet:USER:ALL	User Preset Menu

Power On Mode Preset	:SYSTem:PON:TYPE MODE	System Menu
Power On User Preset	:SYSTem:PON:TYPE USER	System Menu
Power On Last State	:SYSTem:PON:TYPE LAST	System Menu

Mode Setup

See "[Mode Setup](#)" on page 158

Peak Search

Places the selected marker on the trace point with the maximum y-axis value for that marker's trace and accesses a menu that enables you to select to do a next peak or minimum peak search.

Key Path	Front-panel key
Mode	BASIC, PNOISE, WCDMA, C2K, GSM, WIMAXOFDMA, TDSCDMA, 1XEVD0, DVB, DTMB, ISDBT, CMMB, LTE, LTETDD, DCATV, WLAN, MSR,LTEATDD, LTEAFDD
Remote Command	:CALCulate:WAVeform:MARKer[1] 2 ... 12:MAXimum
Example	CALC:WAV:MARK2:MAX
Notes	You must be in a mode that includes the Waveform measurement to use this command. Use INSTRument:SElect to set the mode.
Initial S/W Revision	Prior to A.02.00
Modified at S/W Revision	A.03.00

Next Peak

Moves the selected marker to the next highest local maximum with a value less than that of the current marker.

Key Path	Peak Search
Mode	BASIC, PNOISE, WCDMA, C2K, GSM, WIMAXOFDMA, TDSCDMA, 1XEVD0, DVB, DTMB, ISDBT, CMMB, LTE, LTETDD, DCATV, WLAN, MSR,LTEATDD, LTEAFDD
Remote Command	:CALCulate:WAVeform:MARKer[1] 2 ... 12:MAXimum:NEXT
Example	CALC:WAV:MARK:MAX:NEXT
Notes	You must be in a mode that includes the Waveform measurement to use this command. Use INSTRument:SElect to set the mode.
Initial S/W Revision	Prior to A.02.00
Modified at S/W Revision	A.03.00

Min Search

Moves the selected marker to the minimum y-axis value on the current trace.

Key Path	Peak Search
Mode	BASIC, PNOISE, WCDMA, C2K, GSM, WIMAXOFDMA, TDSCDMA, 1XEVD0, DVB, DTMB, ISDBT, CMMB, LTE, LTETDD, DCATV, WLAN, MSR,LTEATDD, LTEAFDD
Remote Command	:CALCulate:WAVeform:MARKer[1] 2 ... 12:MINimum
Example	CALC:WAV:MARK:MIN
Notes	You must be in a mode that includes the Waveform measurement to use this command. Use INSTRument:SElect to set the mode.

9 Waveform Measurement
Peak Search

Initial S/W Revision	Prior to A.02.00
Modified at S/W Revision	A.03.00

Print

See "Print " on page 165

Quick Save

The Quick Save front-panel key repeats the most recent save that was performed from the Save menu, with the following exceptions:

- Register saves are not remembered as Saves for the purpose of the Quick Save function
- If the current measurement does not support the last non-register save that was performed, an informational message is generated, “File type not supported for this measurement”

Quick Save repeats the last type of qualified save (that is, a save qualified by the above criteria) in the last save directory by creating a unique filename using the Auto File Naming algorithm described below.

If Quick Save is pressed after startup and before any qualified Save has been performed, the Quick Save function performs a Screen Image save using the current settings for Screen Image saves (current theme, current directory), which then becomes the “last save” for the purpose of subsequent Quick Saves.

The Auto File Naming feature automatically generates a file name for use when saving a file. The filename consists of a prefix and suffix separated by a dot, as is standard for the Windows® file system. A default prefix exists for each of the available file types:

Type	Default Prefix	Menu
State	State_	(Save/Recall)
Trace + State	State_	(Save/Recall)
Screen	Screen_	(Save/Recall)
Amplitude Corrections	Ampcor_	(Import/Export)
Traces	Trace_	(Import/Export)
Limit Lines	LLine_	(Import/Export)
Measurement Result	MeasR_	(Import/Export)
Capture Buffer	CapBuf_	(Import/Export)

A four digit number is appended to the prefix to create a unique file name. The numbering sequence starts at 0000 within each Mode for each file type and updates incrementally to 9999, then wraps to 0000 again. It remembers where it was through a Mode Preset and when leaving and returning to the Mode. It is reset by Restore Misc Defaults and Restore System Defaults and subsequent running of the instrument application. So, for example, the first auto file name generated for State files is State_0000.state. The next is State_0001, and so forth.

One of the key features of Auto File Name is that we guarantee that the Auto File Name will never conflict with an existing file. The algorithm looks for the next available number. If it gets to 9999, then it looks for holes. If it find no holes, that is no more numbers are available, it gives an error.

For example, if when we get to State_0010.state there is already a State_0010.state file in the current directory, it advances the counter to State_0011.state to ensure that no conflict will exist (and then it verifies that State_0011.state also does not exist in the current directory and advances again if it does, and so forth).

If you enter a file name for a given file type, then the prefix becomes the filename you entered instead of the default prefix, followed by an underscore. The last four letters (the suffix) are the 4-digit number.

For example, if you save a measurement results file as “fred.csv”, then the next auto file name chosen for a measurement results save will be fred_0000.csv.

NOTE

Although 0000 is used in the example above, the number that is used is actually the current number in the Meas Results sequence, that is, the number that would have been used if you had not entered your own file name.

NOTE

If the filename you entered ends with _dddd, where d=any number, making it look just like an auto file name, then the next auto file name picks up where you left off with the suffix being dddd + 1.

Key Path	Front-panel key
Notes	No remote command for this key specifically.
Initial S/W Revision	Prior to A.02.00

Recall

The **Recall** menu lets you choose what you want to recall, and where you want to recall it from. Among the types of files you can recall are **States and Traces**. In addition, an **Import (Data)** option lets you recall a number of data types stored in CSV files (as used by Excel and other spreadsheet programs).

The default paths for Recall are data type dependent and are the same as for the Save key.

Key Path	Front-panel key
Notes	<p>No remote command for this key specifically, but the :MMEM:LOAD command is available for specific file types. An example is :MMEM:LOAD:STATe <filename>.</p> <p>If you try to recall a State file for a mode that is not licensed or not available in the instrument, an error message will occur and the state will not change.</p>
Backwards Compatibility Notes	<p>In legacy analyzers, it was possible to load a state without affecting the trace data, limit lines or correction data. Similarly (since User Preset is actually loading a state), it was possible to do a User Preset without affecting the trace data, limit lines or correction data.</p> <p>In the X-Series, “state” always includes all of this data; so whenever state is loaded, all of the traces, limit lines and corrections are affected. Although this differs from previous behavior, it is desirable behavior, and should not cause adverse issues for users.</p>
Backwards Compatibility Notes	<p>Recall for the X-Series supports backward compatibility in the sense that you can recall a state file from any X-Series model number and any version of X-Series software. This is only possible if part of the recalling process goes through a limiting step after recalling the mode settings, at least for settings that may vary with version number, model number, option and license differences. If you try to recall a state file onto an instrument with less capability than what was available on the instrument during the save, the recall will ignore the state it doesn't support and it will limit the recalled setting to what it allows.</p> <p>Example: if the saved state includes preamp ON, but the recalling instrument does not have a preamp; the preamp is limited to OFF. Conversely, if you save a state without a preamp, the preamp is OFF in the state file. When this saved file is recalled on an instrument with a licensed preamp, the preamp is changed to OFF. Another example is if the saved state has center frequency set to 20 GHz, but the instrument recalling the saved state is a different model and only supports 13.5 GHz. In this case, the center frequency is limited along with any other frequency based settings. Since the center frequency can't be preserved in this case, the recall limiting tries to at least preserve span to keep the measurement setup as intact as possible.</p> <p>It may be appropriate to issue a warning if the state is limited on the recall; warnings do not go out to SCPI so this would only affect the manual user.</p> <p>Note that there is no state file compatibility outside of the X-Series. For example, you cannot recall a state file from ESA or PSA.</p>
Initial S/W Revision	Prior to A.02.00

State

The **Recall State** menu lets you choose a register or file from which to recall the state.

The content of a state file includes all of the settings and data required to return the analyzer as closely as possible to the Mode it was in, with the exact settings that were in place, when the save occurred. The Mode settings in each state file include the settings that are affected by Mode Preset, as well as the

additional settings affected by Restore Mode Defaults; all of the Mode’s settings. In addition, all of the settings of the **Input/Output** system are included, even though they are outside of the Mode’s state, because they are needed to restore the complete setup. Persistent System settings (for example, GPIB address) are not affected by either a Mode Preset or Restore Mode Defaults, nor are they included in a saved State file.

Since each state file is only for one Mode, the settings for other Modes are unaffected when it is loaded. **Recall State** will cause a mode switch if the state being recalled is not from the current active mode.

After the recall completes, the message "File <filename> recalled" or “Recalled State Register <register number>” is displayed.

For rapid recalls, the State menu lists 16 registers that you can choose from to recall. Pressing a Register key initiates the recall. You can also select a file from which to recall.

The default path for all State Files is:

My Documents\<<mode name>\state

where <mode name> is the parameter used to select the mode with the INST:SEL command (for example, SA for the Spectrum Analyzer).

See ["More Information" on page 586](#).

Key Path	Recall
Mode	All
Remote Command	:MMEMory:LOAD:STATe <filename>
Example	:MMEM:LOAD:STAT "myState.state" This recalls the file myState.state on the default path
Example	MMEM:LOAD:STAT "MyStateFile.state" This loads the state file data (on the default file directory path) into the instrument state.
Notes	<p>When you pick a file to recall, the analyzer first verifies that the file is recallable in the current instrument by checking the software version and model number of the instrument. If everything matches, a full recall proceeds by aborting the currently running measurement, clearing any pending operations, and then loading the State from the saved state file. You can open state files from any mode, so recalling a State file switches to the mode that was active when the save occurred. After switching to the mode of the saved state file, mode settings and data (if any for the mode) are loaded with values from the saved file. The saved measurement of the mode becomes the newly active measurement and the data relevant to the measurement (if there is any) is recalled.</p> <ul style="list-style-type: none"> • If there is a mismatch between file version or model number or instrument version or model number, the recall function tries to recall as much as possible and returns a warning message. It may limit settings that differ based on model number, licensing or version number. <p>After recalling the state, the Recall State function does the following:</p> <ul style="list-style-type: none"> • Makes the saved measurement for the mode the active measurement. • Clears the input and output buffers. • Status Byte is set to 0. • Executes a *CLS <p>If the file specified is empty an error is generated. If the specified file does not exist, another error is generated. If there is a mismatch between the file and the proper file type, an error is generated. If</p>

	there is a mismatch between file version or model number or instrument version or model number, a warning is displayed. Then it returns to the State menu and File Open dialog goes away. After the Recall, the analyzer exits the Recall menu and returns to the previous menu.
Backwards Compatibility SCPI	:MEMory:LOAD:STATe 1,<filename> For backwards compatibility, the above syntax is supported. The "1" is simply ignored.
Initial S/W Revision	Prior to A.02.00

More Information

In measurements that support saving Traces, for example, Swept SA, the Trace data is saved along with the State in the State file. When recalling the State, the Trace data is recalled as well. Traces are recalled exactly as they were stored, including the writing mode and update and display modes. If a Trace was updating and visible when the State was saved, it will come back updating and visible, and its data will be rewritten right away. When you use State to save and recall traces, any trace whose data must be preserved should be placed in View or Blank mode before saving.

The following table describes the Trace Save and Recall possibilities:

You want to recall state and one trace's data, leaving other traces unaffected.	Save Trace+State from 1 trace. Make sure that no other traces are updating (they should all be in View or Blank mode) when the save is performed.	On Recall, specify the trace you want to load the one trace's data into. This trace will load in View. All other traces' data will be unaffected, although their trace mode will be as it was when the state save was performed.
You want to recall all traces	Save Trace+State from ALL traces.	On Recall, all traces will come back in View (or Blank if they were in Blank or Background when saved)
You want all traces to load exactly as they were when saved.	Save State	On recall, all traces' mode and data will be exactly as they were when saved. Any traces that were updating will have their data immediately overwritten.

From File...

When you press "From File", the analyzer brings up a Windows dialog and a menu entitled "File Open." This menu allows you to navigate to the various fields in the Windows dialog without using a keyboard or mouse. The **Tab** and **Arrow** keys can also be used for dialog navigation.

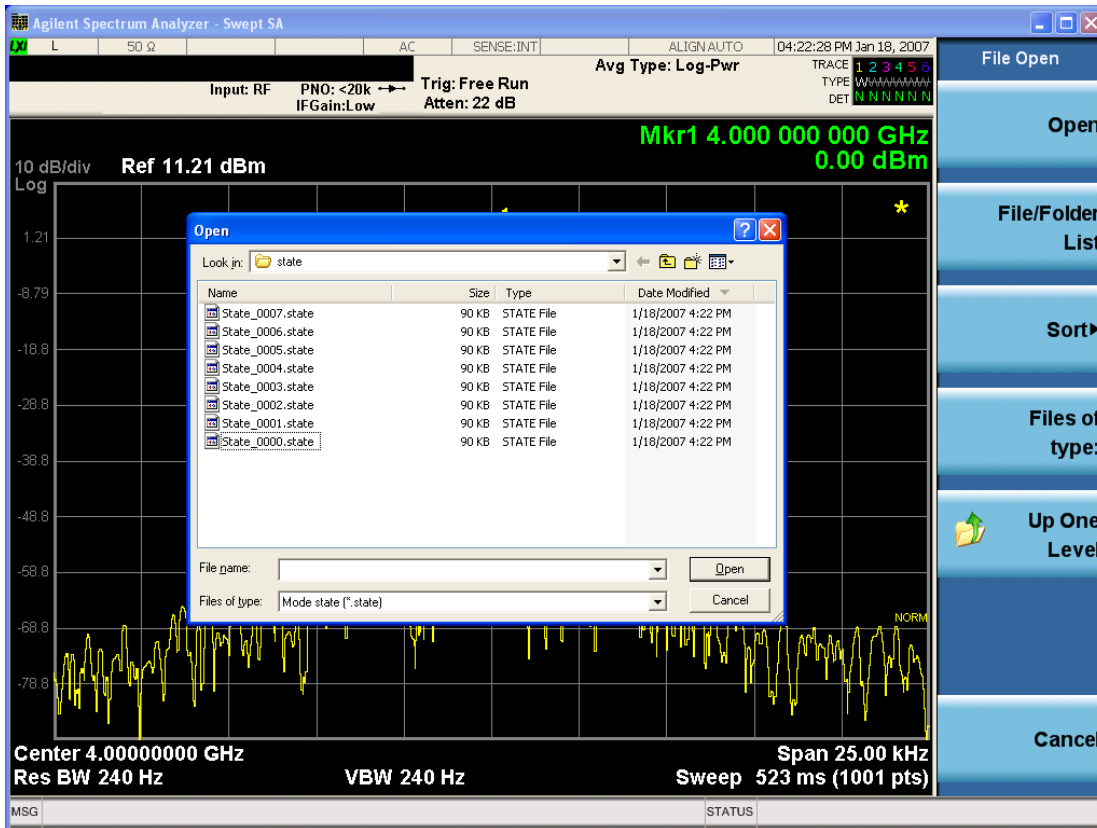

Listed below are the functions of the various fields in the dialog, and the corresponding softkeys:

Open

Performs the recall of the specified file. While the recall is being performed, the floppy icon appears briefly in the Meas bar.

File/Folder List

Enables you to navigate to the center of the dialog that contains the list of files and folders. Once here you can get information about the file and use the tab keys to navigate to the other fields in the dialog, such as Look In.

Look In

The **Look In** field shows the path from which the file will be recalled and allows you to change the path using the up and down arrow keys to navigate to other paths; the Enter key to open a directory; and the Backspace key to go back one directory. The **Look In** field first uses the last path from the Save As dialog **Save In:** path for that same file type. There is no softkey for directly navigating to the Look In field, but you can use the left tab to get here from the File/Folder List.

User specified paths are remembered when you leave and return to a Mode and are reset back to the default using **Restore Mode Defaults**.

Sort

Accesses a menu that enables you to sort the files within the File Open dialog. Only one sorting type can be selected at a time and the sorting happens immediately. The sorting types are **By Date**, **By Name**, **By extension**, and **By Size**.

Files of Type

This field shows the file suffix for the type of file you have selected to recall. For example, if you navigated here while recalling State, "Mode state (*.state)" is in the field. If you navigated here while recalling Trace, ""Mode state (*.trace)" is in the field. If you navigated here while importing a trace data file, "Trace Data (*.csv)" is in the field. For some file types, there is more than one choice in the dropdown menu, which you can select by using the up and down arrow keys and Enter.

Up One Level

This key corresponds to the icon of a folder with the up arrow that is in the tool bar of the dialog. When pressed, it causes the file and folder list to navigate up one level in the directory structure. The Backspace key does the same thing.

Cancel

This key corresponds to the **Cancel** selection in the dialog. It causes the current **Open** request to be cancelled. The ESC key does the same thing.

Key Path	Recall, State
Notes	Brings up the Open dialog for recalling a State Save Type
Initial S/W Revision	Prior to A.02.00

Edit Register Names

You may enter a custom name on any of the Register keys, to help you remember what you are using that state to save. To do this, press the **Edit Register Names** key, choose the register whose name you wish to edit, and then enter the desired label using the Alpha Editor or an external PC keyboard.

The maximum number of characters that can be added is 30. In most cases, 30 characters will fit on two lines of the key.

For more information and the SCPI command, see Edit Register Names under the **Save, State** function.

Key Path	Recall, State
Mode	All
Dependencies	N9060A-7FP or N9060B-2FP license required to edit the register names. When the feature is not licensed, sending the SCPI command generates an error, -221, "Settings conflict;Option not available"
Initial S/W Revision	A.11.00

Register 1 thru Register 16

Selecting any one of these register keys causes the State of the mode from the specified Register to be recalled. Each of the register keys annotates whether it is empty or at what date and time it was last

modified. In addition, you can use the **Edit Register Names** key under **Save, State** to enter custom names for each register.

Registers are shared by all modes, so recalling from any one of the registers will cause a mode switch to the mode that was active when the save to the Register occurred.

Although these 16 registers are the only registers available from the front panel, there are 128 state registers available in the instrument. Registers 17–128 are only available from the SCPI interface, using the *RCL command.

After the recall completes, the message "Register <register number> recalled" appears in the message bar. If you are in the Spectrum Analyzer Mode, and you are recalling a register that was saved in the Spectrum Analyzer Mode, then after the recall, you will still be in the Recall Register menu. If the Recall causes you to switch modes, then after the Recall, you will be in the Frequency menu.

If a requested register is empty an error is generated.

Key Path	Recall, State
Example	*RCL 1
Range	1–16 from front panel, 1–128 from SCPI
Readback	Date and time with seconds resolution are displayed on the key OR A custom name of up to 30 characters entered using the Save, State,Edit Register Names key OR “(empty)” if no prior save operation has been performed to this register.
Initial S/W Revision	Prior to A.02.00
Modified at S/W Revision	Prior to A.11.00

Register 1 thru Register 16

Selecting any one of these register keys causes the State of the mode from the specified Register to be recalled. Each of the register keys annotates whether it is empty or at what date and time it was last modified. In addition, you can use the **Edit Register Names** key under **Save, State** to enter custom names for each register.

Registers are shared by all modes, so recalling from any one of the registers will cause a mode switch to the mode that was active when the save to the Register occurred.

Although these 16 registers are the only registers available from the front panel, there are 128 state registers available in the instrument. Registers 17–128 are only available from the SCPI interface, using the *RCL command.

After the recall completes, the message "Register <register number> recalled" appears in the message bar. If you are in the Spectrum Analyzer Mode, and you are recalling a register that was saved in the Spectrum Analyzer Mode, then after the recall, you will still be in the Recall Register menu. If the Recall causes you to switch modes, then after the Recall, you will be in the Frequency menu.

If a requested register is empty an error is generated.

Key Path	Recall, State
Example	*RCL 1
Range	1-16 from front panel, 1-128 from SCPI
Readback	Date and time with seconds resolution are displayed on the key OR A custom name of up to 30 characters entered using the Save, State,Edit Register Names key OR “(empty)” if no prior save operation has been performed to this register.
Initial S/W Revision	Prior to A.02.00
Modified at S/W Revision	Prior to A.11.00

Sequences

These keys allow you to import a Tab separated or .txt file that will automatically setup all the parameters required for building a Sequence. The parameters will automatically be loaded into the Stated Sequencer.

Once selected, in order to import the selected Sequence Type you must select the Open key in the Source Sequence menu.

Key Path	Recall, Sequences
Mode	All
Remote Command	:MMEMory:LOAD:SEquences: SLIS ALIS SAALIS "MySequence.txt"
Example	:MMEM:LOAD:SEQ:SLIS "MySequence.txt"
Notes	Available file types are: –CSV (Comma delimited) (*.csv) –Text (Tab delimited) (*.txt)
Initial S/W Revision	A.05.00

Source Sequence

The list of parameters, that configure steps, that makes up a sequence for the Source.

The Source sequence is a sequence of flexible configurable steps that can be set anywhere in the instruments frequency range.

Key Path	Recall, Sequences
Example	:MMEM:LOAD:SEQ:SLIS "MySequence.txt"
Dependencies	Only available in XOBT
Initial S/W Revision	A.05.00

Open...

When you press “Open”, the analyzer brings up a Windows dialog and a menu entitled “**File Open.**” This menu allows you to navigate to the various fields in the Windows dialog without using a keyboard or mouse. The **Tab** and **Arrow** keys can also be used for dialog navigation.

See "[From File...](#)" on page 586 in **Recall, State**, for a full description of this dialog and menu.

Key Path	Recall, Data
Notes	The key location is mode-dependent and will vary. Brings up Open dialog for recalling a <mode specific> Save Type
Initial S/W Revision	Prior to A.02.00

Data (Import)

Importing a data file loads data that was previously saved from the current measurement or from other measurements and/or modes that produce compatible data files. The Import Menu only contains Data Types that are supported by the current measurement.

Since the commonly exported data files are in .csv format, the data can be edited by the user prior to importing. This allows you to export a data file, manipulate the data in Excel (the most common PC Application for manipulating .csv files) and then import it.

Importing Data loads measurement data from the specified file into the specified or default destination, depending on the data type selected. Selecting an Import Data menu key will not actually cause the importing to occur, since the analyzer still needs to know from where to get the data. Pressing the Open key in this menu brings up the Open dialog and Open menu that provides you with the options from where to recall the data. Once a filename has been selected or entered in the Open menu, the recall occurs as soon as the Open button is pressed.

Key Path	Recall
Mode	All
Notes	The menu is built from whatever data types are available for the mode. Some keys will be missing completely, so the key locations in the sub-menu will vary. No SCPI command directly controls the Data Type that this key controls. The Data Type is included in the MMEM:LOAD commands.
Dependencies	If a file type is not used by a certain measurement, it is grayed out for that measurement. The key for a file type will not show at all if there are no measurements in the Mode that support it.
Preset	Is not affected by Preset or shutdown, but is reset during Restore Mode Defaults
Readback	The data type that is currently selected
Initial S/W Revision	Prior to A.02.00

Amplitude Correction

This key selects the Amplitude Corrections as the data type to be imported. When pressed a second time, it brings up the Select Menu, which lets you select the Correction into which the data will be imported.

Amplitude Corrections are fully discussed in the documentation of the Input/Output key, under the Corrections key.

A set of preloaded Corrections files can be found in the directory

/My Documents/ EMC Limits and Ampcor.

When the Amplitude Correction is an Antenna correction and the Antenna Unit in the file is not **None**, the Y Axis Unit setting will change to match the Antenna Unit in the file.

Key Path	Recall
Mode	SA EDGE GSM PN
Remote Command	:MMEMory:LOAD:CORRection 1 2 3 4 5 6 7 8, <filename>
Example	:MMEM:LOAD:CORR 2, "myAmpcor.csv" recalls the Amplitude Correction data from the file myAmpcor.csv in the current directory to the 2nd Amplitude Correction table, and turns on Correction 2. The default path is D:\User_My_Documents\Instrument\My Documents\amplitudeCorrections\
Dependencies	<p>Only the first correction array (Correction 1) supports antenna units. This means that a correction file with an Antenna Unit can only be loaded into the Corrections 1 register. Consequently only for Correction 1 does the dropdown in the Recall dialog include.ant, and if an attempt is made to load a correction file into any other Correction register which DOES contain an antenna unit, a Mass Storage error is generated.</p> <p>Corrections are not supported by all Measurements. If in a Mode in which some Measurements support it, this key will be grayed out in measurements that do not. The key will not show at all if no measurements in the Mode support it.</p> <p>Errors are reported if the file is empty or missing, or if the file type does not match, or if there is a mismatch between the file type and the destination data type. If any of these occur during manual operation, the analyzer returns to the Import Data menu and the File Open dialog goes away.</p> <p>This key does not appear unless you have the proper option installed in your instrument.</p> <p>This command will generate an "Option not available" error unless you have the proper option installed in your instrument.</p>
Couplings	When a correction file is loaded from mass storage, it is automatically turned on (Correction ON) and ApplyCorrections is set to On. This allows you to see its effect, thus confirming the load.
Readback	selected Correction
Backwards Compatibility SCPI	:MMEMory:LOAD:CORRection ANTenna CABLE OTHer USER, <filename> For backwards compatibility, ANTenna maps to 1, CABLE maps to 2, OTHer maps to 3 and USER maps to 4
Initial S/W Revision	A.02.00

Amplitude Correction

These keys let you select which Correction to import the data into. Once selected, the key returns back to the Import Data menu and the selected Correction number is annotated on the key. The next step is to select the Open key in the Import Data menu.

Antenna corrections are a particular kind of Amplitude Corrections – they are distinguished in the corrections file by having the Antenna Unit set to a value other than None. Only Correction 1 supports Antenna Units.

Key Path	Recall, Data, Amplitude Correction
Notes	auto return
Dependencies	Only Correction 1 may be used to load a Correction that contains an Antenna Unit other than None
Preset	Not part of Preset, but is reset to Correction 1 by Restore Input/Output Defaults; survives shutdown.
State Saved	The current Correction number is saved in instrument state
Initial S/W Revision	A.02.00

Open...

When you press “Open”, the analyzer brings up a Windows dialog and a menu entitled “**File Open.**” This menu allows you to navigate to the various fields in the Windows dialog without using a keyboard or mouse. The **Tab** and **Arrow** keys can also be used for dialog navigation.

See "[From File...](#)" on page 586 in **Recall, State**, for a full description of this dialog and menu.

Key Path	Recall, Data
Notes	The key location is mode-dependent and will vary. Brings up Open dialog for recalling a <mode specific> Save Type
Initial S/W Revision	Prior to A.02.00

Restart

The Restart function restarts the current sweep, or measurement, or set of averaged/held sweeps or measurements. If you are Paused, pressing Restart does a Resume.

The Restart function is accessed in several ways:

- Pressing the Restart key
- Sending the remote command INIT:IMMEDIATE
- Sending the remote command INIT:RESTART

See "[More Information](#)" on page 594

Key Path	Front-panel key
Remote Command	:INITiate[:IMMEDIATE] :INITiate:RESTART
Example	:INIT:IMM :INIT:REST
Notes	:INITiate:RESTART and :INITiate:IMMEDIATE perform exactly the same function.
Couplings	Resets average/hold count k. For the first sweep overwrites all active (update=on) traces with new current data. For application modes, it resets other parameters as required by the measurement.
Status Bits/OPC dependencies	This is an Overlapped command. The STATus:OPERation register bits 0 through 8 are cleared. The STATus:QUESTionable register bit 9 (INTegrity sum) is cleared. The SWEEPING bit is set. The MEASURING bit is set.
Backwards Compatibility Notes	For Spectrum Analysis mode in ESA and PSA, the Restart hardkey and the INITiate:RESTART command restart trace averages (displayed average count reset to 1) for a trace in Clear Write , but did not restart Max Hold and Min Hold . In the X-Series, the Restart hardkey and the INITiate:RESTART command restart not only Trace Average , but MaxHold and MinHold traces as well. For wireless comms modes in ESA and PSA, the Restart hardkey and the INITiate:RESTART command restart every measurement, which includes all traces and numeric results. There is no change to this operation.
Initial S/W Revision	Prior to A.02.00

More Information

The **Restart** function first aborts the current sweep/measurement as quickly as possible. It then resets the sweep and trigger systems, sets up the measurement and initiates a new data measurement sequence with a new data acquisition (sweep) taken once the trigger condition is met.

If the analyzer is in the process of aligning when **Restart** is executed, the alignment finishes before the restart function is performed.

Even when set for Single operation, multiple sweeps may be taken when Restart is pressed (for example, when averaging/holding is on). Thus when we say that **Restart** "restarts a measurement," we may mean:

- It restarts the current sweep
- It restarts the current measurement
- It restarts the current set of sweeps if any trace is in Trace Average, Max Hold or Min Hold
- It restarts the current set of measurements if Averaging, or Max Hold, or Min Hold is on for the measurement
- depending on the current settings.

With **Average/Hold Number** (in **Meas Setup** menu) set to 1, or Averaging off, or no trace in Trace Average or Hold, a single sweep is equivalent to a single measurement. A single sweep is taken after the trigger condition is met; and the analyzer stops sweeping once that sweep has completed. However, with **Average/Hold Number** >1 and at least one trace set to **Trace Average, Max Hold, or Min Hold (SA Measurement)** or **Averaging on (most other measurements)**, multiple sweeps/data acquisitions are taken for a single measurement. The trigger condition must be met prior to each sweep. The sweep is stopped when the average count k equals the number N set for **Average/Hold Number**. A measurement average usually applies to all traces, marker results, and numeric results; but sometimes it only applies to the numeric results.

Once the full set of sweeps has been taken, the analyzer will go to idle state. To take one more sweep without resetting the average count, increment the average count by 1, by pressing the step up key while **Average/Hold Number** is the active function, or sending the remote command `CALC:AVER:TCON UP`.

Save

The **Save** menu lets you choose what you want to save and where you want to save it. Among the types of files you can save are **States**, **Traces**, and **Screen Images**. In addition, an **Export (Data)** option lets you save a number of data types as CSV files for easy import into Excel and other spreadsheet programs.

Key Path	Front-panel key
Mode	All
Notes	No remote command for this key specifically, but the :MMEM:STORe command is available for specific file types. An example is :MMEM:STOR:STATe <filename>.
Initial S/W Revision	Prior to A.02.00

State

The Save State menu lets you choose a register or file for saving the state.

The content of a state file includes all of the settings and data required to return the analyzer as closely as possible to the Mode it was in, with the exact settings which were in place, when the save occurred. The Mode settings in each state file include the settings that are affected by Mode Preset, as well as the additional settings affected by Restore Mode Defaults; all of the Mode's settings. In addition, all of the settings of the **Input/Output** system are included, even though they are outside of the Mode's state, because they are needed to restore the complete setup. Persistent **System** settings (for example, Verbose SCPI) are not affected by either Mode Preset or Restore Mode Defaults, nor are they included in a saved State file.

After the save completes, the message "File <filename> saved" or "State Register <register number> saved" is displayed.

For rapid saving, the State menu lists 16 registers to save to. Pressing a Register key initiates the save. You can also select a file to save to.

The default path for all State Files is:

My Documents\<<mode name>\state

where <mode name> is the parameter used to select the mode with the INST:SEL command (for example, SA for the Spectrum Analyzer).

Key Path	Save
Mode	All
Remote Command	:MMEMory:STORe:STATe <filename>
Example	MMEM:STOR:STATe "MyStateFile.state" This stores the current instrument state data in the file MyStateFile.state in the default directory.
Notes	Both single and double quotes are supported for any filename parameter over remote. After saving to a register, that register's menu key is updated with the date the time, unless a custom label has been entered for that key. After saving to a register, you remain in the Save State menu, so that you can see the Register key

update. After saving to a file, the analyzer automatically returns to the previous menu and any Save As dialog goes away.

Backwards Compatibility SCPI	:MMEMoRY:STORe:STATe 1, <filename>
Initial S/W Revision	Prior to A.02.00

To File . . .

When you press “To File”, the analyzer brings up a Windows dialog and a menu entitled “**Save As.**” This menu allows you to navigate to the various fields in the Windows dialog without using a keyboard or mouse. The **Tab** and **Arrow** keys can also be used for dialog navigation.

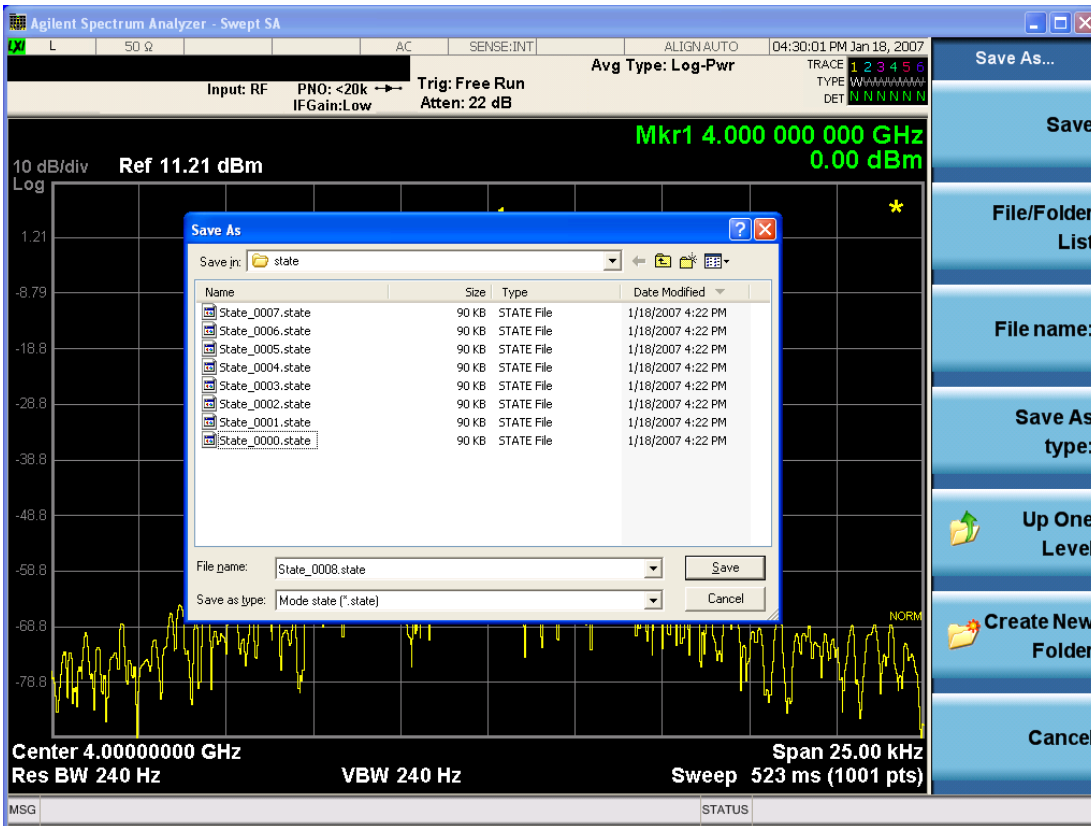

The Listed below

are the functions of the various fields in the dialog, and the corresponding softkeys:

Save

Performs the save to the specified file of the selected type. If the file already exists, a dialog will appear that allows you to replace the existing file by selecting **OK**, or you can **Cancel** the request. If you select **OK**, the file will be overwritten. Using the C: drive is strongly discouraged, since it runs the risk of being overwritten during an instrument software upgrade.

While the save is being performed, the floppy icon appears briefly in the Meas bar.

File/Folder List

Enables you to navigate to the center of the dialog that contains the list of files and folders. Once here you can get information about the file and use the tab keys to navigate to the other fields in the dialog, such as Save In.

Save In

The Save In field shows the path to which the file will be saved and allows you to change the path using the up and down arrow keys to navigate to other paths; the Enter key to open a directory; and the Backspace key to go back one directory. The **Save In field** defaults to the default path for this type of file and remembers the last path you used to save this type of file. There is no softkey for directly navigating to the Save In field but you can use left tab to get here from the File/Folder List.

User specified paths are remembered when you leave and return to a Mode and are reset back to the default using **Restore Mode Defaults**.

File Name

The **File Name** field is initially loaded with an automatically generated filename specific to the appropriate Save Type. The automatically generated filename is guaranteed not to conflict with any filename currently in the directory. You may replace or modify this filename using the File Name key. See the ["Quick Save " on page 582](#) documentation for more on the automatic file naming algorithm.

When you press the **File Name** key the analyzer displays the Alpha Editor. Use the knob to choose the letter to add and the front-panel Enter key to add the letter to the file name. The BK character moves you back and the FW character moves you forward in the filename. The Select key on the front panel generates a space character. When you are done entering the filename press the **Done** softkey. This returns back to the **File Open** dialog and menu, but does not cause the save to occur.

Save As Type

This field shows the file suffix for the type of file you have selected to save. For example, if you navigated here while saving State, "Mode state (*.state)" is in the field. If you navigated here from saving Trace, ""Mode state (*.trace)" is in the field. If you navigated here while exporting a trace data file, "Trace Data (*.csv)" is in the field. For some file types, there is more than one choice in the dropdown, which you can select by using the up and down arrow keys and Enter.

Up One Level

This key corresponds to the icon of a folder with the up arrow that is in the tool bar of the dialog. When pressed, it causes the file and folder list to navigate up one level in the directory structure. The Backspace key does the same thing.

Create New Folder

This key corresponds to the icon of a folder with the "*" that is in the tool bar of the dialog. When pressed, a new folder is created in the current directory with the name **New Folder** and you can enter a new folder name using the Alpha Editor.

Cancel

This key corresponds to the **Cancel** selection in the dialog. It causes the current **Save As** request to be cancelled. The ESC key does the same thing.

Key Path	Save, State
Mode	All
Notes	Brings up Save As dialog for saving a State Save Type
Initial S/W Revision	Prior to A.02.00

Edit Register Names

You may enter a custom name on any of the Register keys, to help you remember what you are using that state to save. To do this, press the **Edit Register Names** key, choose the register whose name you wish to edit, and then enter the desired label using the Alpha Editor or an external PC keyboard.

The maximum number of characters that can be added is 30. In most cases, 30 characters will fit on two lines of the key.

See "[More Information](#)" on page 599

Key Path	Save, State
Mode	All
Remote Command	:MMEMory:REGister:STATe:LABel <reg number>,"label" :MMEMory:REGister:STATe:LABel? <reg number>
Example	:MMEM:REG:STAT:LAB 1,"my label"
Notes	<reg number> is an integer from 1 to 16. If the SCPI specifies an invalid register number an error message is generated, -222,"Data out of range;Invalid register label number" "label" is a string from 0 to 30 characters in length. If a label exceeds 30 characters, an error message is generated, -150,"String data error;Label clipped to 30 characters" "label" of length 0 erases the custom label and restores the default (time and date) label. E.g.: :MMEM:REG:STAT:LAB 1,""
Dependencies	N9060A-7FP or N9060B-2FP license required to edit the register names. When the feature is not licensed, sending this command generates an error, -221,"Settings conflict;Option not available"
Preset	The names are unaffected by Preset or power cycle but are set to the default label (time and date) on a "Restore System Defaults->Misc"
Initial S/W Revision	A.11.00

More Information

When you edit one of the register names, the time and date field will be replaced by the custom name.

If you delete all the characters in the custom name, it restores the default (time and date).

The register names are stored within the state files, but they are not part of the instrument state; that is, once you have edited a register name, loading a new state will not change that register name. Another consequence of this is that the names will be persistent through a power cycle. Also, if a named state file is transferred to another analyzer, it will bring its custom name along with it.

If you try to edit the name of an empty register, the analyzer will first save the state to have a file to put the name in. If you load a named state file into an analyzer with older firmware it will ignore the metadata.

The *SAV and *RCL commands will not be affected by the custom register names, nor will the MMEM commands.

Register 1 thru Register 16

Selecting any one of these register menu keys causes the State of the currently active mode to be saved to the specified Register. The registers are provided for rapid saving and recalling, since you do not need to specify a filename or navigate to a file. Each of the register menu keys annotates whether it is empty or at what date and time it was last modified. In addition, you can use the **Edit Register Names** key to enter custom names for each register.

Although these 16 registers are the only registers available from the front panel, there are 128 state registers available in the instrument. Registers 17–128 are only available from the SCPI interface, using the *SAV command.

There is one set of 128 state registers in the instrument, not one set for each Mode. When a state is saved, the Mode it was saved from is saved with it; then when it is recalled, the instrument switches to that Mode.

After the save completes, the corresponding register menu key annotation is updated with the date and time and the message "Register <register number> saved" is displayed.

Key Path	Save, State
Mode	All
Example	*SAV 1
Range	1–16 from front panel, 1–128 from SCPI
Readback	Date and time with seconds resolution are displayed on the key OR A custom name of up to 30 characters entered using the Edit Register Names key OR “(empty)” if no prior save operation has been performed to this register.
Initial S/W Revision	Prior to A.02.00
Modified at S/W Revision	A.11.00

Register 1 thru Register 16

Selecting any one of these register menu keys causes the State of the currently active mode to be saved to the specified Register. The registers are provided for rapid saving and recalling, since you do not need to specify a filename or navigate to a file. Each of the register menu keys annotates whether it is empty or at what date and time it was last modified. In addition, you can use the **Edit Register Names** key to enter custom names for each register.

Although these 16 registers are the only registers available from the front panel, there are 128 state registers available in the instrument. Registers 17–128 are only available from the SCPI interface, using the *SAV command.

There is one set of 128 state registers in the instrument, not one set for each Mode. When a state is saved, the Mode it was saved from is saved with it; then when it is recalled, the instrument switches to that Mode.

After the save completes, the corresponding register menu key annotation is updated with the date and time and the message "Register <register number> saved" is displayed.

Key Path	Save, State
Mode	All
Example	*SAV 1
Range	1–16 from front panel, 1–128 from SCPI
Readback	Date and time with seconds resolution are displayed on the key OR A custom name of up to 30 characters entered using the Edit Register Names key OR “(empty)” if no prior save operation has been performed to this register.
Initial S/W Revision	Prior to A.02.00
Modified at S/W Revision	A.11.00

Mass Storage Catalog (Remote Command Only)

Key path	SCPI Only
Remote Command	:MMEMory:CATalog? [<directory_name>]
Notes	The string must be a valid logical path. Queries disk usage information (drive capacity, free space available) and obtains a list of files and directories in a specified directory in the following format: <numeric_value>,<numeric_value>,{<file_entry>} It returns two numeric parameters and as many strings as there are files and directories. The first parameter indicates the total amount of storage currently used in bytes. The second parameter indicates the total amount of storage available, also in bytes. The <file_entry> is a string. Each <file_entry> indicates the name, type, and size of one file in the directory list: <file_name>,<file_type>,<file_size> As the windows file system has an extension that indicates file type, <file_type> is always empty. <file_size> provides the size of the file in bytes. For directories, <file_entry> is surrounded by square brackets and both <file_type> and <file_size> are empty
Initial S/W Revision	Prior to A.02.00

Mass Storage Change Directory (Remote Command Only)

Key path	SCPI Only
Remote Command	:MMEMory:CDIRectory [<directory_name>] :MMEMory:CDIRectory?

Notes	<p>The string must be a valid logical path.</p> <p>Changes the default directory for a mass memory file system. The <directory_name> parameter is a string. If no parameter is specified, the directory is set to the *RST value.</p> <p>At *RST, this value is set to the default user data storage area, that is defined as System.Environment.SpecialFolder.Personal.</p> <p>Query returns full path of the default directory.</p>
Initial S/W Revision	Prior to A.02.00

Mass Storage Copy (Remote Command Only)

Key path	SCPI Only
Remote Command	:MMEMory:COpy <string>,<string>[,<string>,<string>]
Notes	<p>The string must be a valid logical path.</p> <p>Copies an existing file to a new file or an existing directory to a new directory.</p> <p>Two forms of parameters are allowed. The first form has two parameters. In this form, the first parameter specifies the source, and the second parameter specifies the destination.</p> <p>The second form has four parameters. In this form, the first and third parameters specify the source. The second and fourth parameters specify the directories. The first pair of parameters specifies the source. The second pair specifies the destination. An error is generated if the source doesn't exist or the destination file already exists.</p> <p>This command will generate an "access denied" error if the destination is a restricted folder (e.g., C:\Windows) and the current user does not have Power User or Administrator privileges.</p>

Mass Storage Device Copy (Remote Command Only)

This command transfers data to/from a file and a peripheral device.

Key path	SCPI Only
Remote Command	:MMEMory:COpy:DEvice <source_string>,<dest_string>
Notes	<p>The strings must be a valid logical path or a valid device keyword. If the dest_string is a device keyword, the data is copied from the source file to the device. If the source_string is a device keyword, the data is copied to the source file from the device.</p> <p>Valid device keywords are:</p> <p>SNS (smart noise source)</p> <p>An error is generated if the file or device is not found.</p>

Mass Storage Delete (Remote Command Only)

Key path	SCPI Only
Remote Command	:MMEMory:DElete <file_name>[,<directory_name>]

Notes	The string must be a valid logical path. Removes a file from the specified directory. The <file_name> parameter specifies the file name to be removed. This command will generate an “access denied” error if the file is in a restricted folder (e.g., C:\Windows) and the current user does not have Power User or Administrator privileges.
Initial S/W Revision	Prior to A.02.00

Mass Storage Data (Remote Command Only)

Creates a file containing the specified data OR queries the data from an existing file.

Key path	SCPI Only
Remote Command	:MMEMory:DATA <file_name>, <data> :MMEMory:DATA? <file_name>
Notes	The string must be a valid logical path. The command form is MMEMory:DATA <file_name>,<data>. It loads <data> into the file <file_name>. <data> is in 488.2 block format. <file_name> is string data. The query form is MMEMory:DATA? <file_name> with the response being the associated <data> in block format.
Initial S/W Revision	Prior to A.02.00

Mass Storage Make Directory (Remote Command Only)

Key path	SCPI Only
Remote Command	:MMEMory:MDIRectory <directory_name>
Notes	The string must be a valid logical path. Creates a new directory. The <directory_name> parameter specifies the name to be created. This command will generate an “access denied” error if the new directory would be in a restricted folder (e.g., C:\Windows) and the current user does not have Power User or Administrator privileges.
Initial S/W Revision	Prior to A.02.00

Mass Storage Move (Remote Command Only)

Key path	SCPI Only
Remote Command	:MMEMory:MOVE <string>,<string>[,<string>,<string>]
Notes	The string must be a valid logical path. Moves an existing file to a new file or an existing directory to a new directory. Two forms of parameters are allowed. The first form has two parameters. In this form, the first parameter specifies the source, and the second parameter specifies the destination. The second form has four parameters. In this form, the first and third parameters specify the source.

	<p>The second and fourth parameters specify the directories. The first pair of parameters specifies the source. The second pair specifies the destination. An error is generated if the source doesn't exist or the destination file already exists.</p> <p>This command will generate an "access denied" error if the destination is a restricted folder (e.g., C:\Windows) and the current user does not have Power User or Administrator privileges.</p>
Initial S/W Revision	Prior to A.02.00

Mass Storage Remove Directory (Remote Command Only)

Key path	SCPI Only
Remote Command	:MMEMory:RDIRECTory <directory_name>
Notes	<p>The string must be a valid logical path.</p> <p>Removes a directory. The <directory_name> parameter specifies the directory name to be removed. All files and directories under the specified directory shall also be removed.</p> <p>This command will generate an "access denied" error if the folder is a restricted folder (e.g., C:\Windows) or is in a restricted folder and the current user does not have Power User or Administrator privileges.</p>
Initial S/W Revision	Prior to A.02.00

Sequences

These keys allow you to save a Tab separated or CSV file of the setup parameters required to build a Sequence.

In order to save you must select the Save As button and choose a destination folder.

Key Path	Save, Sequences
Mode	All
Remote Command	:MMEM:STOR:SEQuences: SLIST ALIST SAAList SSTep "MySequence.txt"
Example	:MMEM:STOR:SEQ:SLIST "MySequence.txt"
Notes	<p>Available file types are:</p> <ul style="list-style-type: none"> -CSV (Comma delimited) (*.csv) -Text (Tab delimited) (*.txt)
Initial S/W Revision	A.05.00

Source Sequence

The list of parameters, that configure steps, that makes up a sequence for the Source.

The Source sequence is a sequence of flexible configurable steps that can be set anywhere in the instruments frequency range.

Key Path	Save, Sequences
Example	:MMEM:STOR:SEQ:SLIS "MySequence.txt"
Dependencies	Only available in XOBT
Initial S/W Revision	A.05.00

Save As . . .

This menu lets you select the location where you can save the Sequence. This menu is a standard Windows® dialog with Save As menu keys. The "File Name" field in the Save As dialog is initially loaded with an automatically generated filename specific to the appropriate Save Type. The automatically generated filename is guaranteed not to conflict with any filename currently in the directory. You may replace or modify this filename using the File Name softkey. See the Quick Save key documentation for more on the automatic file naming algorithm.

The default path for all Sequence Files is:

My Documents\Sequences

Key Path	Save, Sequences
Mode	All
Notes	Brings up Save As dialog for saving a Sequence Save Type
Initial S/W Revision	A.05.00

Data (Export)

Exporting a data file stores data from the current measurement to mass storage files. The Export Menu only contains data types that are supported by the current measurement.

Since the commonly exported data files are in .csv format, the data can be edited by you prior to importing. This allows you to export a data file, manipulate the data in Excel (the most common PC Application for manipulating .csv files) and then import it.

Selecting an Export Data menu key will not actually cause the exporting to occur, since the analyzer still needs to know where you wish to save the data. Pressing the Save As key in this menu brings up the Save As dialog and Save As menu that allows you to specify the destination file and directory. Once a filename has been selected or entered in the Open menu, the export will occur as soon as the Save key is pressed.

Key Path	Save
Mode	All
Notes	The menu is built from whatever data types are available for the mode. So the key locations in the sub menu will vary. No SCPI command directly controls the Data Type that this key controls. The Data Type is included in

	the MMEM:STORe commands.
Dependencies	If a file type is not used by a certain measurement, that type is grayed out for that measurement. The key for a file type will not show at all if there are no measurements in the Mode that support it.
Preset	Is not affected by a Preset or shutdown, but is reset during Restore Mode Defaults
Readback	The data type that is currently selected
Initial S/W Revision	Prior to A.02.00

Amplitude Correction

Pressing this key selects **Amplitude Corrections** as the data type to be exported. Pressing this key again brings up the Select Menu, which allows the user to select which **Amplitude Correction** to save.

Amplitude Corrections are fully discussed in the documentation of the Input/Output key, under the Corrections softkey.

See "[Correction Data File](#)" on page 606

Key Path	Save
Remote Command	:MMEMory:STORe:CORRection 1 2 3 4 5 6, <filename>
Example	:MMEM:STOR:CORR 2 "myAmpcor.csv" saves Correction 2 to the file myAmpcor.csv on the current path. The default path is My Documents\amplitudeCorrections.
Notes	If the save is initiated via SCPI, and the file already exists, the file will be overwritten. Using the C: drive is strongly discouraged, since it runs the risk of being overwritten during an instrument software upgrade. Both single and double quotes are supported for any filename parameter over SCPI.
Dependencies	Corrections are not supported by all Measurements. If in a Mode in which some Measurements support it, this key will be grayed out in measurements that do not. The key will not show at all if no measurements in the Mode support it. This key will not appear unless you have the proper option installed in your instrument.
Readback	Selected Correction
Backwards Compatibility SCPI	:MMEMory:STORe:CORRection ANTenna CABLe OTHer USER, <filename> For backwards compatibility, ANTenna maps to 1, CABLe maps to 2, OTHer maps to 3 and USER maps to 4
Initial S/W Revision	A.02.00

Correction Data File

A Corrections Data File contains a copy of one of the analyzer correction tables. Corrections provide a way to adjust the trace display for predetermined gain curves (such as for cable loss).

Corrections files are text files in .csv (comma separated values) form, to make them importable into Excel or other spreadsheet programs. The format for Corrections files is as follows.

Line #	Type of field	Example	Notes
1	File type, must be "Amplitude Correction"	Amplitude Correction	May not be omitted
2	File Description (in quotes)	"Correction Factors for 11966E"	60 characters max; may be empty but may not be omitted. If exceeds 60 characters, error -233 Too much data reported
3	Comment (in quotes)	"Class B Radiated"	60 characters max; may be empty but may not be omitted. . If exceeds 60 characters, error -233 Too much data reported
4	Instrument Version, Model #	A.02.06,N9020A	May be empty but may not be omitted
5	Option List, File Format Version	K03 LFE EXM ,01	May be empty but may not be omitted
6	Freq Unit to be used for all frequency values in the file	Frequency Unit,MHz	assumed to be Hz if omitted
7	Antenna Unit	Antenna Unit,None	If omitted leaves the Antenna unit unchanged. The amplitude unit in the Antenna Unit field is a conversion factor that is used to adjust the Y Axis Units of the current mode, if the mode supports Antenna Units. For more details on antenna correction data, refer to the Input/Output,Corrections key description. Allowable values: dBuv/m, dBuA/m, dBG, dBpT, None
8	Freq Interpolation	Frequency Interpolation,Linear	if omitted leaves the Freq Interpolation unchanged. Allowable values: Linear, Logarithmic
9	Bias value in mA	Bias,0.00	If omitted leaves the Bias value unchanged (added as of A.08.50)
10	Bias State	Bias State,On	If omitted leaves the Bias State unchanged. Allowable values: On, Off (added as of A.08.50)
11	Overlap, two values, Freq1 and Freq2, separated by commas.	Overlap,33500,40000	Uses Freq Unit from line 6. Thus, in this example Freq1=33.5 GHz, Freq2= 40.0 GHz (see note below). If omitted leaves the overlap unchanged (added as of A.08.50)
12	DATA marker	DATA	Corrections data begins in the next line

Lines 2 through 5 can be empty but must appear in the file. Lines 6 through 11 are optional, the lines can be left out of the file altogether.

The Overlap row and the two Bias rows apply only to external mixing. Both are read-only, they are never written by the analyzer. The only way to insert or modify these rows is to edit the file with a text editor or a spreadsheet editor. These rows are intended for use by mixer manufacturers, as they allow the manufacturer to insert data about how the mixer corrections were generated and how they should be applied. The Bias rows allow you to specify whether to turn Bias on or off when the Correction is turned on and to specify a Bias value (turning off the Correction does not change the Bias, but turning it back on again sets it to the value specified in the file). The Overlap row allows you to specify an overlap region in which two different corrections may be applied. It is expected that in the corrections data itself, there will be TWO corrections values exactly at Max Freq, otherwise Overlap is ignored. The way the overlap is processed is as follows: if at any given time the current analyzer Start Freq is greater than Freq 1 and lower than Freq 2, and the current Stop Freq is greater than Freq 2, extend the first correction point at or above Freq 2 down to Freq 1, rather than using the correction data between Freq1 and Freq2.

The Antenna Unit row can only be used in Correction register 1, because there can only be one setting for Antenna Unit at any given time. If a Correction whose Antenna Unit is set to anything but None is loaded into any Correction register but 1, an error is generated (Mass storage error; Can only load an Antenna Unit into Correction 1). When a correction file is saved from any Correction register but 1, Antenna Unit is always written as None.

Similarly, the Bias rows can only be used in Correction register 1, because there can only be one setting for Bias at any given time. If a Correction file with a Bias or Bias State row is loaded into any Correction register but 1, an error is generated: Mass storage error; Can only load Bias Settings into Correction 1

The data follows the DATA row, as comma separated X, Y pairs; one pair per line.

For example, suppose you have an Antenna to correct for on an N9020A version A.02.06 and the correction data is:

- 0 dB at 200 MHz
- 17 dB at 210 MHz
- 14.8 dB at 225 MHz

Then the file will look like:

- Amplitude Correction
- "Correction Factors for 11966E"
- "Class B Radiated"
- A.02.06,N9020A
- P13 EA3 UK6,01
- Frequency Unit,MHz
- Antenna Unit,dBuV/m
- Frequency Interpolation,Linear
- DATA
- 200.000000,0.00
- 210.000000,17.00

- 225.000000,14.80

The choices for the 1 of N fields in the metadata are as follows:

- Frequency Unit: Hz, kHz, MHz, GHz
- Antenna Unit: dBuV/m, dBuA/m, dBG, dBpT, None
- Frequency Interpolation: Logarithmic, Linear

Amplitude Correction

These keys let you choose which Correction to save. Once selected, the key returns back to the Export Data menu and the selected Correction number is annotated on the key.

The next step in the Save process is to select the Save As key in the Export Data menu.

Key Path	Save, Data, Amplitude Correction
Preset	Not part of a Preset, but is reset to Correction 1 by Restore Input/Output Defaults. Survives a shutdown.
Readback	1
Initial S/W Revision	A.02.00

Measurement Results

Pressing this key selects Meas Results as the data type to be exported. Pressing the key a second time brings up the Meas Results menu, which allows you to select which **Meas Result** to save. In the Swept SA measurement, there are three types of Measurement Results files: Peak Table, Marker Table and Spectrogram.

See "[Meas Results File Contents](#)" on page 610.

See "[Marker Table](#)" on page 610.

See "[Peak Table](#)" on page 613.

See "[Spectrogram](#)" on page 615

Remote Command	:MMEMory:STORe:RESults:MTABle PTABle SPECTrogram <filename>
Example	:MMEM:STOR:RES:MTAB "myResults.csv" Saves the results from the current marker table to the file myResults.csv in the current path. :MMEM:STOR:RES:PTAB "myResults.csv" Saves the results from the current peak table to the file myResults.csv in the current path. :MMEM:STOR:RES:SPEC "myResults.csv" Saves the results from the current Spectrogram display to the file myResults.csv in the current path. The default path is My Documents\SA\data\SAN\results
Notes	If the save is initiated via SCPI, and the file already exists, the file will be overwritten. Using the C: drive is strongly discouraged, since it runs the risk of being overwritten during an instrument software upgrade. Both single and double quotes are supported for any filename parameter over SCPI.

Dependencies	<p>If a save of Marker Table results is requested and the Marker Table is not on, no file is saved and a message is generated</p> <p>If a save of Peak Table results is requested and the Peak Table is not on, no file is saved and a message is generated</p> <p>If a save of Spectrogram results is requested and the Spectrogram is not on, no file is saved and a message is generated.</p> <p>The Spectrogram choice only appears if option EDP is licensed.</p>
Preset	Not part of Preset, but is reset to Peak Table by Restore Mode Defaults. Survives a shutdown.
Initial S/W Revision	Prior to A.02.00

Meas Results File Contents

All files are .csv files. The following section details the data in each file type.

Marker Table

This section discusses the Marker Table Meas Results file format.

Imagine that, at the point where a Marker Table Meas Result is requested, the following screen is showing:

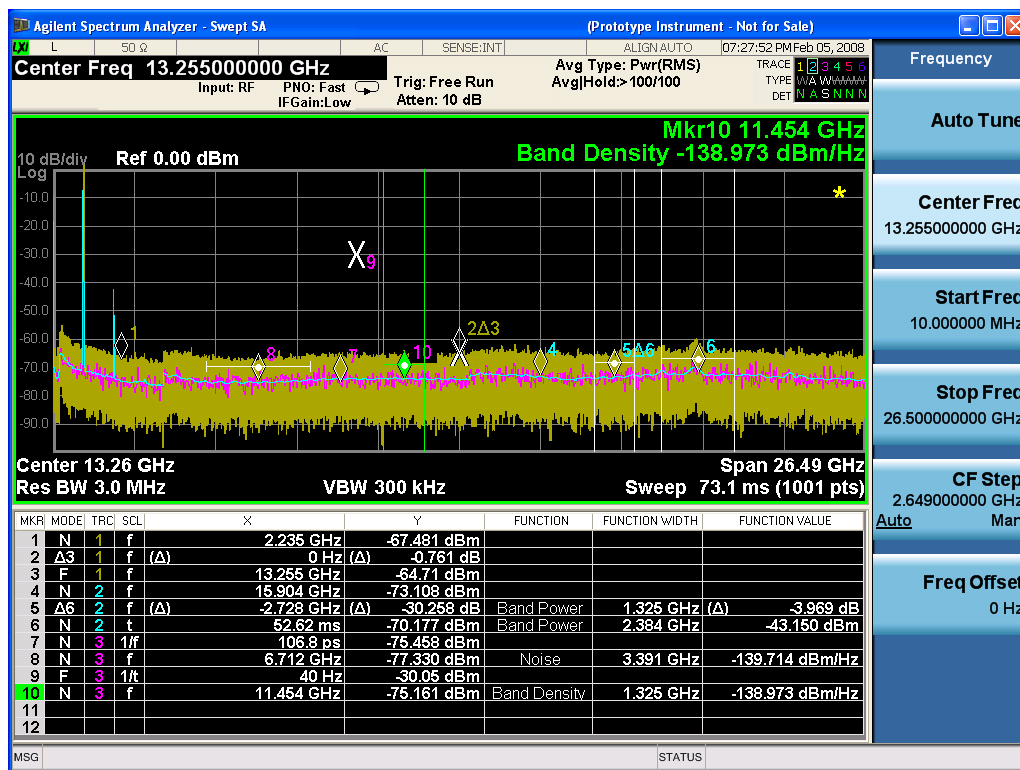

Then the Meas Results file, when opened, would show the following data:

MeasurementR
esult

Swept SA	
A.01.40_R0017	N9020A
526 B25 PFR P26 EA3	1
Result Type	Marker Table
Ref Level	0
Number of Points	1001
Sweep Time	0.0662666 67
Start Frequency	10000000
Stop Frequency	26500000 000
Average Count	0
Average Type	LogPower (Video)
RBW	3000000
RBW Filter	Gaussian
RBW Filter BW	3dB
VBW	3000000
Sweep Type	Swept
X Axis Scale	Lin
PreAmp State	Off
PreAmp Band	Low
Trigger Source	Free
Trigger Level	1.2
Trigger Slope	Positive
Trigger Delay	1.00E-06
Phase Noise Optimization	Fast
Swept If Gain	Low
FFT If Gain	Autorange
RF Coupling	AC
FFT Width	411900
Ext Ref	10000000
Input	RF
RF Calibrator	Off

Attenuation	10								
Ref Level Offset	0								
External Gain	0								
X Axis Units	Hz								
Y Axis Units	dBm								
DATA									
MKR	MODE	TRC	SCL	X	Y	FUNCTI ON	FUNCTIO N WIDTH	FUNCTI ON VALUE	FUNCTI ON UNIT
1	Normal	1	Freque ncy	2.2350E+ 09	- 67.4 81	Off	0.0000E+ 00	0	None
2	Delta3	1	Freque ncy	0.0000E+ 00	- 0.76 1	Off	0.0000E+ 00	0	None
3	Fixed	1	Freque ncy	1.3255E+ 10	- 64.7 1	Off	0.0000E+ 00	0	None
4	Normal	2	Freque ncy	1.5904E+ 10	- 73.1 08	Off	0.0000E+ 00	0	None
5	Delta7	2	Freque ncy	- 2.7280E+ 09	- 30.2 58	Band Power	1.3250E+ 06	-3.969	dB
6	Normal	2	Time	5.2620E- 02	- 70.1 77	Band Power	2.3840E+ 06	-43.15	dBm
7	Normal	3	Period	1.0680E- 10	- 75.4 58	Off	0.0000E+ 00	0	None
8	Normal	3	Freque ncy	6.7120E+ 09	- 77.3 3	Noise	3.3910E+ 06	- 139.71 4	dBm/Hz
9	Fixed	3	Inverse Time	4.0000E+ 01	- 30.0 5	Off	0.0000E+ 00	0	None
10	Normal	3	Freque ncy	1.1454E+ 10	- 75.1 61	Band Density	1.3250E+ 06	- 138.97 3	dBm/Hz
11	Off	1	Freque ncy	0.0000E+ 00	0	Off	0.0000E+ 00	0	None
12	Off	1	Freque ncy	0.0000E+ 00	0	Off	0.0000E+ 00	0	None

The numbers appear in the file exactly as they appear onscreen. If it says 11.454 GHz onscreen, then in the file it is 11.454E+09.

The metadata header is very similar to the metadata used in the trace data .csv files. See Trace File Contents. The only new information concerns the 1-of-N fields in the marker table itself.

Peak Table

This section discusses the Peak Table Meas Results file format.

Imagine that, at the point where a Marker Table Meas Result is requested, the following screen is showing:

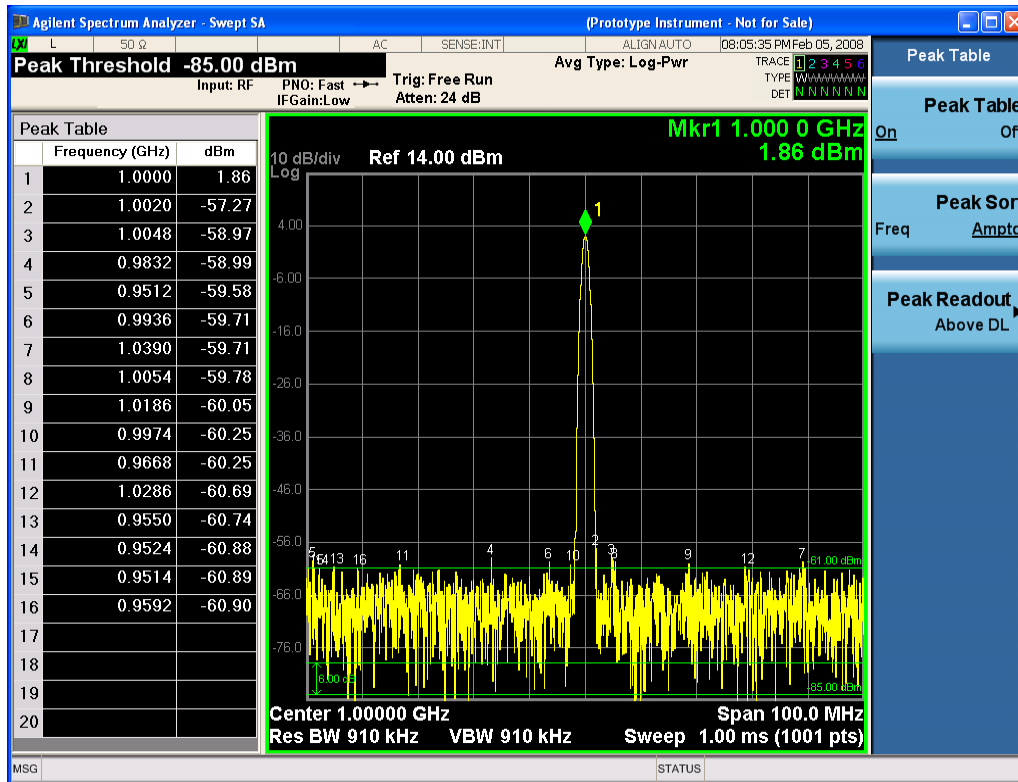

Then the Meas Results file, when opened, would show the header data (the same as for the Marker Table except that the Result Type is Peak Table) ending with a few fields of specific interest to Peak Table users:

- Peak Threshold
- Peak Threshold State (On|Off)
- Peak Excursion
- Peak Excursion State (On|Off)
- Display Line
- Peak Readout (All|AboveDL|BelowDL)
- Peak Sort (Freq|Amptd)

These fields are then followed by the data for the Peak Table itself.

Note that the label for the Frequency column changes to Time in 0 span.
Here is what the table for the above display looks like:

MeasurementResult	
Swept SA	
A.01.40_R0017	N9020A
526 B25 PFR P26 EA3	1
Result Type	Peak Table
Ref Level	0
Number of Points	1001
Sweep Time	0.066266667
Start Frequency	10000000
Stop Frequency	26500000000
Average Count	0
Average Type	LogPower(Video)
RBW	3000000
RBW Filter	Gaussian
RBW Filter BW	3dB
VBW	3000000
Sweep Type	Swept
X Axis Scale	Lin
PreAmp State	Off
PreAmp Band	Low
Trigger Source	Free
Trigger Level	1.2
Trigger Slope	Positive
Trigger Delay	1.00E-06
Phase Noise Optimization	Fast
Swept If Gain	Low
FFT If Gain	Autorange
RF Coupling	AC
FFT Width	411900
Ext Ref	10000000
Input	RF
RF Calibrator	Off
Attenuation	10
Ref Level Offset	0
External Gain	0

X Axis Units	Hz	
Y Axis Units	dBm	
Peak Threshold	-85	
Peak Threshold State	On	
Peak Excursion	6	
Peak Excursion State	On	
Display Line	-61	
Peak Readout	AboveDL	
Peak Sort	Amptd	
DATA		
Peak	Frequency	Amplitude
1	1.0000E+06	1.86
2	1.0020E+06	-57.27
3	1.0048E+06	-58.97
4	9.8320E+05	-58.99
5	9.5120E+05	-59.58
6	9.9360E+05	-59.71
7	1.0390E+06	-59.71
8	1.0054E+06	-59.78
9	1.1086E+06	-60.05
10	9.9740E+05	-60.25
11	9.6680E+05	-60.25
12	1.0286E+06	-60.69
13	9.5500E+05	-60.74
14	9.5240E+05	-60.88
15	9.5140E+05	-60.89
16	9.5920E+05	-60.90
17		
18		
19		
20		

Spectrogram

This section discusses the Spectrogram Results file format. The Spectrogram choice only appears if option EDP is licensed.

The Spectrogram results are the same as a Trace data export, except that instead of having just one trace's data, all 300 traces appear one after the other.

Each trace has its own data mark; the data for Spectrogram Trace 0 follows the row marked DATA, the data for Spectrogram Trace 1 follows the row marked DATA1, for Spectrogram Trace 2 follows the row marked DATA2, and so on.

Each DATA row has a timestamp in the second column (as of firmware revision A.11.01). So, for example, if Trace 0 had a relative start time of 1729.523 sec, then the first DATA row would look like this:

```
DATA,1729.523
```

And if Trace 13 had a relative start time of 100.45 sec, then the fourteenth data row would look like:

```
DATA13,100.453
```

To find the absolute time for the relative timestamps of each trace, the last row before the first DATA row gives the absolute start time of the Spectrogram, in the form YYYYMMDDHHMMSS

So, for example, if the absolute start time is 13:23:45:678 on January 30, 2012, this row would look like:

```
Start Time,20120130132345678
```

NOTE:

NOTE

The resolution of the absolute time stored is 1 ms, which matches up with the fact that the fastest sweep time is also 1 ms. However, there is no specification for the absolute accuracy of the clock in the analyzer, nor is there any facility provided to allow the user to set this time to any particular degree of accuracy.

Traces that have not yet been filled in the Spectrogram display are empty; there is no DATA header for them. The file ends after the last non-empty trace.

Imagine that, at the point where a Spectrogram Meas Result is requested, the following screen is showing:



For the purpose of this example, we have set the Average/Hold Number to 10, thus we have only traces 0 thru 10. The Spectrogram was started at 02:28:08:700 pm on April 25, 2012 (that is, 700 ms after 2:28:08 pm), although the screen dump itself shows a different time, as it was taken ten minutes after the Spectrogram data. Trace 0 is showing a start time of 5.30 seconds, meaning 5.3 seconds after the Spectrogram started (trace 10 has a start time of 0, as it was the first trace taken but has now rolled up into the tenth trace slot).

The Meas Results file, when opened, shows the header data and ten traces of trace data. Below is an extract from the result file for the above display. Note the start time of 20120425142808700 showing in the last row before the first DATA row, and the relative time of 5.299231048 showing in the first DATA row:

Result Type	Spectrogram
MeasResult	
Swept SA	
A.11.00.01	N9020A
503 508 513 526 ALL ALV B1C B1X B25 B2X B40 BAB BBA CR3 CRP DP2 DRD EA3 EDP EMC EP1 ERC ESC ESP EXM FSA HBA K03 LFE MPB P03 P08 P13 P26 PFR RTL RTS S40 SB1 SEC SM1 UK6 YAS YAV	1
Segment	0

Result Type	Spectrogram
Number of Points	1001
Sweep Time	0.523333333
Start Frequency	5999984415
Stop Frequency	6000009415
Average Count	0
Average Type	LogPower(Video)
RBW	240
RBW Filter	Gaussian
RBW Filter BW	3dB
VBW	240
Sweep Type	Swept
X Axis Scale	Lin
PreAmp State	Off
PreAmp Band	Low
Trigger Source	Free
Trigger Level	1.2
Trigger Slope	Positive
Trigger Delay	0
Phase Noise Optimization	Wide
Swept If Gain	Low
FFT If Gain	Autorange
RF Coupling	AC
FFT Width	411900
Ext Ref	10000000
Input	RF
RF Calibrator	Off
Attenuation	14
Ref Level Offset	0
External Gain	0
Trace Type	Clearwrite
Detector	Normal
Trace Math	Off
Trace Math Oper1	Trace5
Trace Math Oper2	Trace6
Trace Math Offset	0
Trace Name	Trace1

Result Type	Spectrogram
X Axis Units	Hz
Y Axis Units	dBm
Start Time	20120425142808700
DATA	5.299231048
5999984415	-76.34749519
5999984440	-77.28097006
5999984465	-75.32317869
5999984490	-73.64417681
5999984515	-72.67154604

O
O
O

6000009315	-77.94423277
6000009340	-79.51829697
6000009365	-78.46108961
6000009390	-78.46108957
6000009415	-76.59570596
DATA2	4.708697055
5999984415	-80.98197882
5999984440	-80.98197879
5999984465	-75.83142132
5999984490	-74.02712079
5999984515	-73.57213005

O
O
O

6000009315	-75.9183103
6000009340	-79.53787488
6000009365	-78.82602191
6000009390	-78.82602188
6000009415	-76.37486709

DATA10	0
5999984415	-75.56751112
5999984440	-75.76485645
5999984465	-76.67718717
5999984490	-78.79238489
5999984515	-83.72680212

o
o
o

6000009315	-71.3942461
6000009340	-72.28308332
6000009365	-73.92684489
6000009390	-75.45548832
6000009415	-75.17904815

Save As . . .

When you press “Save As”, the analyzer brings up a Windows dialog and a menu entitled “**Save As.**” This menu allows you to navigate to the various fields in the Windows dialog without using a keyboard or mouse. The **Tab** and **Arrow** keys can also be used for dialog navigation.

See "[To File . . .](#)" on page 597 in **Save, State** for a full description of this dialog and menu.

The default path for saving files is:

For all of the Trace Data Files:

My Documents\<<mode name>\data\traces

For all of the Limit Data Files:

My Documents\<<mode name>\data\limits

For all of the Measurement Results Data Files:

My Documents\<<mode name>\data\<<measurement name>\results

For all of the Capture Buffer Data Files:

My Documents\<<mode name>\data\captureBuffer

Key Path	Save, Data
Mode	All

Notes	<p>The key location is mode-dependent and will vary.</p> <p>Brings up the Save As dialog for saving a <mode specific> Save Type. The save is performed immediately and does not wait until the measurement is complete.</p>
Initial S/W Revision	Prior to A.02.00

Screen Image

Pressing Screen Image accesses a menu of functions that enable you to specify a format and location for the saved screen image. It brings up a menu that allows you to specify the color scheme of the Screen Image (Themes) or navigate to the Save As dialog to perform the actual save.

Screen Image files contain an exact representation of the analyzer display. They cannot be loaded back onto the analyzer, but they can be loaded into your PC for use in many popular applications.

The image to be saved is actually captured when the **Save** front panel key is pressed, and kept in temporary storage to be used if you ask for a Screen Image save. When the Screen Image key is pressed, a "thumbnail" of the captured image is displayed, as shown below:

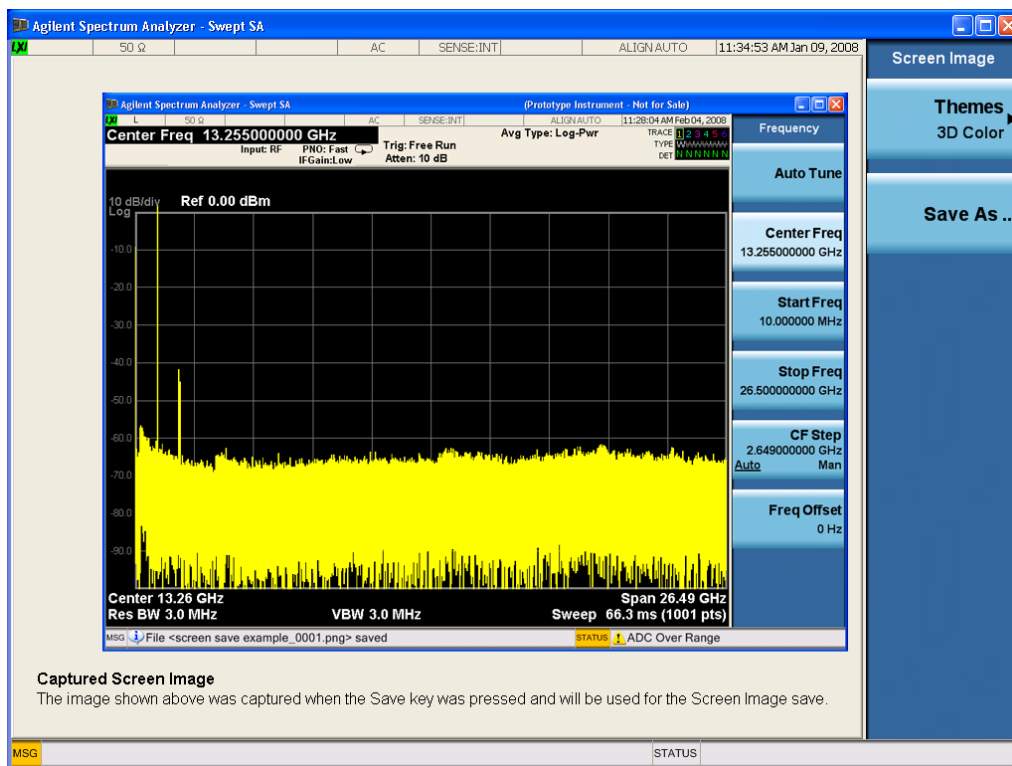

When you continue on into the **Save As** menu and complete the Screen Image save, the image depicted in the thumbnail is the one that gets saved, showing the menus that were on the screen before going into the **Save** menus. The save is performed immediately and does not wait until the measurement is complete.

After you have completed the save, the **Quick Save** front-panel key lets you quickly repeat the last save performed, using an auto-named file, with the current screen data.

NOTE

For versions previous to A.01.55, if you initiate a screen image save by navigating through the Save menus, the image that is saved will contain the Save menu softkeys, not the menus and the active function that were on the screen when you first pressed the Save front panel key.

Key Path	Save
Mode	All
Remote Command	:MMEMory:STORe:SCReen <filename>
Example	:MMEM:STOR:SCR "myScreen.png" This stores the current screen image in the file MyScreenFile.png in the default directory.
Initial S/W Revision	Prior to A.02.00

Themes

Accesses a menu of functions that enable you to choose the theme to be used when saving the screen image.

The **Themes** option is the same as the **Themes** option under the **Display** and **Page Setup** dialogs. It allows you to choose between themes to be used when saving the screen image.

Key Path	Save, Screen Image
Remote Command	:MMEMory:STORe:SCReen:THEMe TDColor TDMonochrome FCOlor FMONochrome :MMEMory:STORe:SCReen:THEMe?
Example	:MMEM:STOR:SCR:THEM TDM
Preset	3D Color; Is not part of Preset, but is reset by Restore Misc Defaults or Restore System Defaults All and survives subsequent running of the modes.
Readback	3D Color 3D Mono Flat Color Flat Mono
Backwards Compatibility Notes	In ESA and PSA we offer the choice of "Reverse Bitmap" or "Reverse Metafile" when saving screen images. This is much like the "Flat Color" theme available in X-Series. Also, if you selected Reverse Bitmap AND a black & white screen image, that would be much like "Flat Monochrome". In other words, each of the X-Series themes has a similar screen image type in ESA/PSA. But they are not identical.
Initial S/W Revision	Prior to A.02.00

3D Color

Selects a standard color theme with each object filled, shaded and colored as designed.

Key Path	Save, Screen Image, Themes
Example	MMEM:STOR:SCR:THEM TDC
Readback	3D Color
Initial S/W Revision	Prior to A.02.00

3D Monochrome

Selects a format that is like 3D color but shades of gray are used instead of colors.

Key Path	Save, Screen Image, Themes
Example	MMEM:STOR:SCR:THEM TDM
Readback	3D Mono
Initial S/W Revision	Prior to A.02.00

Flat Color

Selects a format that is best when the screen is to be printed on an ink printer.

Key Path	Save, Screen Image, Themes
Example	MMEM:STOR:SCR:THEM FCOL
Readback	Flat Color
Initial S/W Revision	Prior to A.02.00

Flat Monochrome

Selects a format that is like Flat Color. But only black is used (no colors, not even gray), and no fill.

Key Path	Save, Screen Image, Themes
Example	MMEM:STOR:SCR:THEM FMON
Readback	Flat Mono
Initial S/W Revision	Prior to A.02.00

Save As...

When you press "Save As", the analyzer brings up a Windows dialog and a menu entitled "**Save As.**" This menu allows you to navigate to the various fields in the Windows dialog without using a keyboard or mouse. The **Tab** and **Arrow** keys can also be used for dialog navigation.

See "[To File ...](#)" on page 597 in **Save, State** for a full description of this dialog and menu.

The default path for Screen Images is

My Documents\`<mode name>`\screen.

where `<mode name>` is the parameter used to select the mode with the INST:SEL command (for example, SA for the Spectrum Analyzer).

Key Path	Save, Screen Image
Notes	Brings up Save As dialog for saving a Screen Image Save Type
Initial S/W Revision	Prior to A.02.00

9 Waveform Measurement
Save

Single (Single Measurement/Sweep)

Sets the analyzer for Single measurement operation. The single/continuous state is Meas Global, so the setting will affect all the measurements. If you are Paused, pressing **Single** does a Resume.

See "[More Information](#)" on page 625

Key Path	Front-panel key
Example	:INIT:CONT OFF
Notes	See Cont key description.
Backwards Compatibility Notes	<p>For Spectrum Analysis mode in ESA and PSA, the Single hardkey and the INITiate:IMM switched from continuous measurement to single measurement and restarted sweeps and averages (displayed average count reset to 1), but did not restart Max Hold and Min Hold. In the X-Series, the Single hardkey and the INITiate:IMM command initiate a sweep/ measurement/ average sequence/hold sequence including MaxHold and MinHold.</p> <p>For Spectrum Analysis mode in ESA and PSA, the Single hardkey restarted the sweep regardless of whether or not you were in an active sweep or sweep sequence. In the X-Series, Restart does this but Single only restarts the sweep or sweep sequence if you are in the idle state.</p> <p>INIT[:IMM] in ESA & PSA Spectrum Analysis Mode does an implied ABORt. In some other PSA Modes, INIT[:IMM] is ignored if not in the idle state. . The X-Series follows the ESA/PSA SA Mode model, which may cause some Modes to have compatibility problems.</p>
Initial S/W Revision	Prior to A.02.00

More Information

See "[Restart](#)" on page 594 for details on the INIT:IMMEDIATE (Restart) function.

If you are already in single sweep, the INIT:CONT OFF command has no effect.

If you are already in Single Sweep, then pressing the **Single** key in the middle of a sweep does not restart the sweep or sequence. Similarly, pressing the **Single** key does not restart the sweep or sequence if the sweep is not in the idle state (for example, if you are taking a very slow sweep, or the analyzer is waiting for a trigger). Instead, it results in a message. "Already in Single, press Restart to initiate a new sweep or sequence". Even though pressing the **Single** key in the middle of a sweep does not restart the sweep, sending INIT:IMMEDIATE does reset it.

To take one more sweep without resetting the average count, increment the average count by 1, by pressing the step up key while **Average/Hold Number** is the active function, or sending the remote command CALC:AVER:TCON UP.

Source

Opens a menu of keys that access various source configuration menus and settings. In the test set, pressing this key also causes the central view area to change and display the Source Control Main view.

Key Path	Front-panel key
----------	-----------------

RF Output

This parameter sets the source RF power output state.

Key Path	Source
Remote Command	:OUTPut[:EXTernal][:STATe] ON OFF 1 0 :OUTPut[:EXTernal][:STATe]?
Example	OUTP OFF OUTP?
Notes	<p>The EXTernal node is shown in RD text so the SCPI remains the same between internal and external source control. However, for EXT we do not wish to document this node to the customer since we are controlling the internal source rather than the external source.</p> <p>This setting is for the independent mode and has no effect on the "List Sequencer" on page 712. If the "Sequencer" on page 713 is set to ON, the list sequencer controls the source output and this key will be grayed-out. And this setting will be none-forceful grey out on front panel to indicate out-of-scope. Non-forceful means user still can change this setting by SCPI but cannot change on front panel. When set to OFF will make source leave list sequencer and this setting will be black out and take effect immediately.</p> <p>When the RF Output is ON, an "RF" annunciator is displayed in the system settings panel. When the RF Output is turned Off, the RF annunciator is cleared. If the "Sequencer" on page 713 is set to ON, the "RF" annunciator will be replaced by "SEQ" in the system settings panel, indicating that the output is controlled by the list sequencer.</p>
Preset	Off
Range	On Off
Initial S/W Revision	A.05.00

Amplitude

Allows you to access the Amplitude sub-menu.

Key Path	Source
Notes	<p>The sub-menu under this button is for independent mode and has no effect on "List Sequencer" on page 712. If the "Sequencer" on page 713 is set to ON, the list sequencer controls the source output and this key will be grayed-out on front panel to indicate out-of-scope. When you set "Sequencer" on page 713 to Off will make source leave list sequencer and this button will be black out.</p>
Initial S/W Revision	A.05.00

RF Power

Allows you to adjust the power level of the source using the numeric keypad, step keys, or RPG. Pressing any digit, 0 through 9, on the numeric keypad brings up the unit terminator.

Please refer to the ["RF Power Range " on page 628](#) table below for the valid ranges.

Key Path	Source, Amplitude
Remote Command	:SOURce:POWer[:LEVel][:IMMediate][:AMPLitude] <ampl> :SOURce:POWer[:LEVel][:IMMediate][:AMPLitude]?
Example	:SOUR:POW -100 dBm
Notes	<p>Amplitude corrections can be specified for use with the source. In the event of amplitude corrections being applied, the valid ranges for the RF power do not change dependant on the current amplitude correction setting. If the combination of RF power + amplitude correction is higher or lower than the source output range, the Source Unleveled bit is set and the "Source Unleveled" indicator will appear on status panel to indicate that the source cannot maintain the output power that has been requested.</p> <p>When signal generator is unable to maintain the requested output level, the "Source Unleveled" indicator will appear on status panel. When the source output setting is restored to the normal range, the "Source Unleveled" is removed from status panel.</p> <p>Internal source has list sequence mode, which comprises of several steps which contain separate output power, frequency and waveform etc. When the source list sequence playing is complete, the last step keeps playing, and user can use this command to change the list sequence last step's output power.</p> <p>The multiport adapter RFIO TX ports and GPS ports cannot ensure power accuracy when power setting is lower than -130dBm, this power setting value is defined by the sum of RF Power setting and related amplitude correction value. But user settable value could be lower than this limit. When application detected there exists power setting lower than -130dBm on MPA RFIO TX ports, then popup warning message . When application detected there exists power setting lower than -130dBm on MPA GPS ports, then popup warning message . This is only warning message, and check is performed when RF is ON.</p>
Notes	The Min and Max value here defined UI settable amplitude range. This range is larger than actual amplitude range with level accuracy defined in spec.
Dependencies	The RF power is dependent on the RF output port and frequency, such that the current frequency and selected output port determine the valid range of power values.
Couplings	If "Real-Time AWGN" on page 673 AWGN State is On and "ARB" on page 662 ARB State is On, this setting will be adjusted to the value to maintain the AWGN power relationship defined by "Power Control Mode" on page 674 Power Control Mode and other noise settings
Preset	-100 dBm
Min	The range of values depends on the current frequency and selected RF output port. Please refer to the "RF Power Range " on page 628 table below for the valid ranges.
Max	The range of values depends on the current frequency and selected RF output port. Please refer to the "RF Power Range " on page 628 table below for the valid ranges.
Initial S/W Revision	A.05.00
Modified at S/W Revision	A.16.00 (Add couplings with AWGN state)

RF Power Range

RF Output Port	Frequency Range	Min Output Power	Max Output Power
High Power RF Out	10 MHz ≤ f ≤ 6 GHz	-150 dBm	20 dBm
RFIO 1 & RFIO 2	10 MHz ≤ f ≤ 6 GHz	-150 dBm	0 dBm
GPS (Note2)	10 MHz ≤ f ≤ 6 GHz	-150 dBm	0 dBm

Note: This is the UI power range, it's larger than actual spec.

Note2: GPS port is on the multiport adapter, or E6607C which has embedded MPA.

Set Reference Power

This key allows you to set the power reference. Pressing this key turns the power reference state to ON, sets the reference power value to the current RF output power, maintains this power at the RF output, and sets the displayed power to 0.00 dB. All subsequent RF power values entered under Source>Amplitude>RF Power are interpreted as being relative to this reference power.

When you use a power reference, the signal generator outputs an RF power that is set relative to the reference power by the value entered under Source>Amplitude>RF Power as follows:

Output power = reference power – entered power

Where:

reference power equals the original RF Power entered under Source>Amplitude>RF Power and set as the reference power

entered power equals a new value entered under Source>Amplitude>Amptd Offset

In addition, the displayed power value is the same as a new value entered under Source>Amplitude>RF Power.

NOTE

If Power Ref is set to ON with a reference value set, entering a value under Source>Amplitude>RF Power and pressing Set Reference Power will add that value to the existing Power Ref value.

If you wish to change the reference power value to a new value entered under Source>Amplitude>RF Power, first you must set Power Ref to OFF and then press Set Reference Power.

Key Path	Source, Amplitude
Dependencies	This key is unavailable, and is grayed out when the " List Sequencer " on page 712 is turned ON.
Initial S/W Revision	A.05.00

Power Ref

This key allows you to toggle the state of the power reference.

When you use a power reference, the signal generator outputs an RF power that is set relative to the reference power by the value entered under Source>Amplitude>RF Power as follows:

Output power = reference power + entered power

Where:

reference power equals the original RF Power entered under Source>Amplitude>RF Power and set as the reference power

entered power equals a new value entered under Source>Amplitude>Amptd Offset

For more information on Reference Frequency refer to ["Set Reference Power " on page 628](#)

Key Path	Source, Amplitude
Remote Command	:SOURce:POWer:REFErence <ampl> :SOURce:POWer:REFErence? :SOURce:POWer:REFErence:STATe OFF ON 0 1 :SOURce:POWer:REFErence:STATe?
Example	:SOUR:POW:REF 0.00 dBm :SOUR:POW:REF:STATe ON
Dependencies	This setting is unavailable and is grayed out when the "List Sequencer" on page 712 is turned ON.
Couplings	This value is coupled to the "Set Reference Power " on page 628 key such that pressing the Set Reference Power key updates the reference power with the current output power.
Preset	0.00 dBm OFF
Min	-125.00 dBm
Max	10.00 dBm
Initial S/W Revision	A.05.00

Amptd Offset

Allows you to specify the RF output power offset value.

When the amplitude offset is set to zero (0) and you set a new offset value (positive or negative), the displayed amplitude value will change as follows and the RF output power will not change:

Displayed value = output power + offset value

Where:

output power equals the original RF Power entered under Source>Amplitude>RF Power

offset value equals the value entered under Source>Amplitude>Amptd Offset

When the amplitude offset is set to a value other than zero (0) and you enter a new RF power value under Source>Amplitude>RF Power, the displayed power will be the same as the value entered and the RF output power will be equal to the value entered minus the offset value as follows:

Output power = entered power – offset power

Displayed Power = output power + offset power

Displayed power = entered power

Where:

entered power equals the amplitude entered under Source>Amplitude>RF Power

offset power equals the value previously entered and set under Source>Amplitude>Amptd Offset

Key Path	Source, Amplitude
Remote Command	:SOURce:POWer[:LEVel][:IMMediate]:OFFSet <rel_amp1> :SOURce:POWer[:LEVel][:IMMediate]:OFFSet?
Example	:SOUR:POW:OFFS 0.00 dB
Dependencies	This setting is unavailable, and is grayed out when the List Sequencer is turned ON.
Preset	0.00 dB
Min	-200.00 dB
Max	200.00 dB
Initial S/W Revision	A.05.00

Modulation

Allows you to toggle the state of the modulation.

Key Path	Source
Remote Command	:OUTPut:MODulation[:STATe] ON OFF 1 0 :OUTPut:MODulation[:STATe]?
Example	:OUTP:MOD OFF
Notes	This setting is for independent mode and has no effect on " List Sequencer " on page 712. If the " Sequencer " on page 713 is set to ON, the list sequencer controls the source output and this key will be grayed-out. And this setting will be none-forceful grey out on front panel to indicate out-of-scope. Non-forceful means user still can change this setting by SCPI but cannot change manually on front panel. When set to Off will make source leave list sequencer and this setting will be black out and take effect immediately. When the Modulation is ON, the "MOD" annunciator is displayed in the system settings panel. When the Modulation is turned Off, the "MOD" annunciator is cleared. If the " Sequencer " on page 713 is set to ON, the "MOD" annunciator will be replaced by "SEQ" in the system settings panel indicating that the output is controlled by list sequencer.
Preset	Off
Range	On Off
Initial S/W Revision	A.05.00

Frequency

Allows you to access the Frequency sub-menu.

Key Path	Source
Notes	The sub-menu under this button is for independent mode and has no effect on "List Sequencer" on page 712 . If the "Sequencer" on page 713 is set to ON, the list sequencer controls the source output and this key will be grayed-out. And this button will be grey out on front panel to indicate out-of-scope. When set to Off will make source leave list sequencer and this button will be black out.
Initial S/W Revision	A.05.00

Frequency

Allows you to set the RF Output Frequency. You can adjust the frequency of the source using the numeric keypad, step keys, or RPG. Pressing any digit, 0 through 9, on the numeric keypad brings up the unit terminator.

Key Path	Source, Frequency
Remote Command	:SOURce:FREQuency[:CW] <freq> :SOURce:FREQuency[:CW] ?
Example	:SOUR:FREQ 1.00 GHz
Notes	Internal source has list sequence mode, which comprises of several steps which contain separate output power, frequency and waveform etc. When the source list sequence playing is complete, the last step keeps playing, and user can use this command to change the list sequence last step's output frequency.
Couplings	The frequency value is coupled to the current channel band and number, such that updates to the band and number will update the frequency value to the corresponding absolute frequency.
Preset	1.00 GHz
Min	10.00 MHz
Max	Hardware Dependant: Option 503 = 3.6 GHz Option 504 = 3.8 GHz Option 506 = 6.00 GHz
Initial S/W Revision	A.05.00

Channel

The frequency of the source can be specified by a channel number of a given frequency band. This key allows you to specify the current channel number. For the appropriate range of channel numbers for a given frequency band, refer to the following tables: ["GSM/EDGE Channel Number Ranges" on page 632](#), ["W-CDMA Channel Number Ranges" on page 633](#), ["CDMA 2000 / 1xEVDO Channel Number Ranges" on page 634](#), and ["LTE FDD Channel Number Ranges" on page 636](#).

Key Path	Source, Frequency
----------	--------------------------

Remote Command	:SOURce:FREQuency:CHANnels:NUMBer <int> :SOURce:FREQuency:CHANnels:NUMBer?
Example	:SOUR:FREQ:CHAN:NUMB 1
Notes	This key is grayed out when the "Radio Standard" on page 640 is set to NONE. This key is grayed out on E6630A.
Dependencies	This key is grayed out when the "Radio Standard" on page 640 is set to NONE. This key is grayed out on E6630A.
Couplings	The channel number is coupled to the frequency value when the "Radio Standard" on page 640 is not set to NONE. When the frequency value is changed, the channel number will increase or decrease to match the new frequency. If the frequency is not at an exact match for a channel number, the nearest channel number is displayed along with a greater than or less than sign to indicate the frequency is above or below the channel number.
Preset	1
Min	Please refer to the tables below for the valid ranges.
Max	Please refer to the tables below for the valid ranges.
Initial S/W Revision	A.05.00

GSM/EDGE Channel Number Ranges

Band	Link (Device)	Range	Frequency (MHz)
P-GSM	Uplink (MS)	$1 \leq n \leq 124$	$890.0 + 0.2*n$
	Downlink (BS)	$1 \leq n \leq 124$	$935.0 + 0.2*n$
E-GSM	Uplink (MS)	$0 \leq n \leq 124$	$890.0 + 0.2*n$
		$975 \leq n \leq 1023$	$890.0 + 0.2*(n-1024)$
	Downlink (BS)	$0 \leq n \leq 124$	$935.0 + 0.2*n$
		$975 \leq n \leq 1023$	$935.0 + 0.2*(n-1024)$
DCS 1800	Uplink (MS)	$512 \leq n \leq 885$	$1710.200 + 0.20*(n-512)$
	Downlink (BS)	$512 \leq n \leq 885$	$1805.200 + 0.20*(n-512)$
PCS 1900	Uplink (MS)	$512 \leq n \leq 810$	$1850.200 + 0.2*(n-512)$
	Downlink (BS)	$512 \leq n \leq 810$	$1930.200 + 0.2*(n-512)$
R-GSM	Uplink (MS)	$0 \leq n \leq 124$	$890.0 + 0.2*n$
		$955 \leq n \leq 1023$	$890.0 + 0.2*(n-1024)$
	Downlink (BS)	$0 \leq n \leq 124$	$935.0 + 0.2*n$
		$955 \leq n \leq 1023$	$935.0 + 0.2*(n-1024)$
GSM 450	Uplink (MS)	$256 \leq n \leq 293$	$450.6 + 0.2*(n-259)$
	Downlink (BS)	$256 \leq n \leq 293$	$460.6 + 0.2*(n-259)$
GSM 480	Uplink (MS)	$306 \leq n \leq 340$	$479.000 + 0.20*(n-306)$
	Downlink (BS)	$306 \leq n \leq 340$	$489.000 + 0.20*(n-306)$
GSM 850	Uplink (MS)	$128 \leq n \leq 251$	$824.200 + 0.20*(n-128)$

Band	Link (Device)	Range	Frequency (MHz)
GSM 700	Downlink (BS)	$128 \leq n \leq 251$	$869.200 + 0.20*(n-128)$
	Uplink (MS)	$438 \leq n \leq 516$	$777.200 + 0.20*(n-438)$
	Downlink (BS)	$438 \leq n \leq 516$	$747.200 + 0.20*(n-438)$
T-GSM810	Uplink (MS)	$350 \leq n \leq 425$	$806.0 + 0.20*(n-350)$
	Downlink (BS)	$350 \leq n \leq 425$	$851.0 + 0.20*(n-350)$

W-CDMA Channel Number Ranges

Band	Link (Device)	Range	Frequency (MHz)
Band I	Downlink	$10562 \leq n \leq 10838$	$n \div 5$
	Uplink	$9612 \leq n \leq 9888$	$n \div 5$
Band II	Downlink	$412 \leq n \leq 687$	$n \div 5 + 1850.1$
		$9662 \leq n \leq 9938$	$n \div 5$
	Uplink	$12 \leq n \leq 287$ $350 \leq n \leq 425$	$n \div 5 + 1850.1$ $n \div 5$
Band III	Downlink	$1162 \leq n \leq 1513$	$n \div 5 + 1575$
	Uplink	$937 \leq n \leq 1288$	$n \div 5 + 1525$
Band IV	Downlink	$537 \leq n \leq 1738$	$n \div 5 + 1805$
		$1887 \leq n \leq 2087$	$n \div 5 + 1735.1$
	Uplink	$1312 \leq n \leq 1513$ $1662 \leq n \leq 1862$	$n \div 5 + 1450$ $n \div 5 + 1380.1$
Band V	Downlink	$1007 \leq n \leq 1087$	$n \div 5 + 670.1$
		$4357 \leq n \leq 4458$	$n \div 5$
	Uplink	$782 \leq n \leq 862$ $4132 \leq n \leq 4233$	$n \div 5 + 670.1$ $n \div 5$
Band VI	Downlink	$1037 \leq n \leq 1062$	$n \div 5 + 670.1$
		$4387 \leq n \leq 4413$	$n \div 5$
	Uplink	$812 \leq n \leq 837$ $4162 \leq n \leq 4188$	$n \div 5 + 670.1$ $n \div 5$
Band VII	Downlink	$2237 \leq n \leq 2563$	$n \div 5 + 2175$
		$2587 \leq n \leq 2912$	$n \div 5 + 2105.1$
	Uplink	$2012 \leq n \leq 2338$ $2362 \leq n \leq 2687$	$n \div 5 + 2100$ $n \div 5 + 2030.1$
Band VIII	Downlink	$2937 \leq n \leq 3088$	$n \div 5 + 340$
	Uplink	$2712 \leq n \leq 2863$	$n \div 5 + 340$
Band IX	Downlink	$9237 \leq n \leq 9387$	$n \div 5$
	Uplink	$8762 \leq n \leq 8912$	$n \div 5$

Band	Link (Device)	Range	Frequency (MHz)
Band X	Downlink	$3112 \leq n \leq 3388$	$n \div 5 + 1490$
		$3412 \leq n \leq 3687$	$n \div 5 + 1430.1$
	Uplink	$2887 \leq n \leq 3163$	$n \div 5 + 1135$
		$3187 \leq n \leq 3462$	$n \div 5 + 1075.1$
Band XI	Downlink	$3712 \leq n \leq 3812$	$n \div 5 + 736$
	Uplink	$3487 \leq n \leq 3587$	$n \div 5 + 733$
Band XII	Downlink	$3837 \leq n \leq 3903$	$n \div 5 - 37$
		$3927 \leq n \leq 3992$	$n \div 5 - 54.9$
	Uplink	$3612 \leq n \leq 3678$	$n \div 5 - 22$
		$3702 \leq n \leq 3767$	$n \div 5 - 39.9$
Band XIII	Downlink	$4017 \leq n \leq 4043$	$n \div 5 - 55$
		$4067 \leq n \leq 4092$	$n \div 5 - 64.9$
	Uplink	$3792 \leq n \leq 3818$	$n \div 5 + 21$
		$3702 \leq n \leq 3767$	$n \div 5 - 39.9$
Band XIV	Downlink	$4117 \leq n \leq 4143$	$n \div 5 - 63$
		$4167 \leq n \leq 4192$	$n \div 5 - 72.9$
	Uplink	$3892 \leq n \leq 3918$	$n \div 5 + 12$
		$3942 \leq n \leq 3967$	$n \div 5 + 2.1$
Band XIX	Downlink	$712 \leq n \leq 763$	$n \div 5 + 735$
		$787 \leq n \leq 837$	$n \div 5 + 720.1$
	Uplink	$312 \leq n \leq 363$	$n \div 5 + 770$
		$387 \leq n \leq 437$	$n \div 5 + 755.1$

CDMA 2000 / 1xEVDO Channel Number Ranges

Band	Link (Device)	Range	Frequency (MHz)
US Cellular	Uplink (MS, reverse link)	$1 \leq N \leq 799$	$0.030 \times N + 825.000$
		$991 \leq N \leq 1023$	$0.030 \times (N - 1023) + 825.000$
		$1024 \leq N \leq 1323$	$0.030 \times (N - 1024) + 815.040$
	Downlink (BS, forward link)	$1 \leq N \leq 799$	$0.030 \times N + 870.000$
		$991 \leq N \leq 1023$	$0.030 \times (N - 1023) + 870.000$
		$1024 \leq N \leq 1323$	$0.030 \times (N - 1024) + 860.040$
US PCS	Uplink (MS, reverse link)	$0 \leq N \leq 1199$	$1850.000 + 0.050 \times N$
	Downlink (BS, forward link)	$0 \leq N \leq 1199$	$1930.000 + 0.050 \times N$
Japan Cellular Band	Uplink (MS, reverse link)	$1 \leq N \leq 799$	$0.0125 \times (N + 915.000)$
		$801 \leq N \leq 1039$	$0.0125 \times (N - 800) + 898.000$

Band	Link (Device)	Range	Frequency (MHz)	
		$1041 \leq N \leq 1199$	$0.0125 \times (N - 1040) + 887.000$	
		$1201 \leq N \leq 1600$	$0.0125 \times (N - 1200) + 893.000$	
		Downlink (BS, forward link)	$1 \leq N \leq 799$	$0.0125 \times (N + 860.000)$
		$801 \leq N \leq 1039$	$0.0125 \times (N - 800) + 843.000$	
		$1041 \leq N \leq 1199$	$0.0125 \times (N - 1040) + 832.000$	
Korean PCS Band	Uplink (MS, reverse link)	$0 \leq N \leq 599$	$0.050 \times N + 1750.000$	
	Downlink (BS, forward link)	$0 \leq N \leq 599$	$0.050 \times N + 1840.000$	
NMT-450 Band	Uplink (MS, reverse link)	$1 \leq N \leq 400$	$0.025 \times (N - 1) + 450.000$	
		$472 \leq N \leq 871$	$0.025 \times (N - 472) + 410.000$	
		$1039 \leq N \leq 1473$	$0.020 \times (N - 1024) + 451.010$	
		$1536 \leq N \leq 1715$	$0.025 \times (N - 1536) + 479.000$	
		$1792 \leq N \leq 2016$	$0.020 \times (N - 1792) + 479.000$	
	Downlink (BS, forward link)	$1 \leq N \leq 400$	$0.025 \times (N - 1) + 460.000$	
		$472 \leq N \leq 871$	$0.025 \times (N - 472) + 420.000$	
		$1039 \leq N \leq 1473$	$0.020 \times (N - 1024) + 461.010$	
		$1536 \leq N \leq 1715$	$0.025 \times (N - 1536) + 489.000$	
		$1792 \leq N \leq 2016$	$0.020 \times (N - 1792) + 489.000$	
IMT-2000 Band	Uplink (MS, reverse link)	$0 \leq N \leq 1199$	$1920.000 + 0.050 \times N$	
	Downlink (BS, forward link)	$0 \leq N \leq 1199$	$2100.000 + 0.050 \times N$	
Upper 700 MHz Band	Uplink (MS, reverse link)	$0 \leq N \leq 240$	$776.000 + 0.050 \times N$	
	Downlink (BS, forward link)	$0 \leq N \leq 240$	$746.000 + 0.050 \times N$	
Secondary 800 MHz Band	Uplink (MS, reverse link)	$0 \leq N \leq 719$	$0.025 \times N + 806.000$	
		$720 \leq N \leq 919$	$0.025 \times (N - 720) + 896.000$	
	Downlink (BS, forward link)	$0 \leq N \leq 719$	$0.025 \times N + 851.000$	
		$720 \leq N \leq 919$	$0.025 \times (N - 720) + 935.000$	
2.5 GHz IMT Extension	Uplink (MS, reverse link)	$0 \leq N \leq 1399$	$2500.000 + 0.050 \times N$	
	Downlink (BS, forward link)	$0 \leq N \leq 1399$	$2620.000 + 0.050 \times N$	
US PCS 1.9 GHz	Uplink (MS, reverse link)	$0 \leq N \leq 1299$	$1850.000 + 0.050 \times N$	
	Downlink (BS, forward link)	$0 \leq N \leq 1299$	$1930.000 + 0.050 \times N$	

Band	Link (Device)	Range	Frequency (MHz)
AWS	Uplink (MS, reverse link)	$0 \leq N \leq 899$	$1710.000 + 0.050 \times N$
	Downlink (BS, forward link)	$0 \leq N \leq 899$	$2100.000 + 0.050 \times N$
US 2.5 GHz	Uplink (MS, reverse link)	$140 \leq N \leq 1459$	$2495.000 + 0.050 \times N$
	Downlink (BS, forward link)	$140 \leq N \leq 1459$	$2617.000 + 0.050 \times N$
700 Public Safety	Uplink (MS, reverse link)	$0 \leq N \leq 240$	$787.000 + 0.050 \times N$
	Downlink (BS, forward link)	$0 \leq N \leq 240$	$757.000 + 0.050 \times N$
C2K Lower 700	Uplink (MS, reverse link)	$0 \leq N \leq 360$	$698.000 + 0.050 \times N$
	Downlink (BS, forward link)	$0 \leq N \leq 360$	$728.000 + 0.050 \times N$
400 Euro PAMR	Uplink (MS, reverse link)	$1 \leq N \leq 400$	$0.025 \times (N-1) + 450.000$
		$472 \leq N \leq 871$	$0.025 \times (N-472) + 410.000$
	Uplink (MS, reverse link)	$1536 \leq N \leq 1715$	$0.025 \times (N-1536) + 479.000$
	Uplink (MS, reverse link)		
	Downlink (BS, forward link)	$1 \leq N \leq 400$	$0.025 \times (N-1) + 460.000$
		$472 \leq N \leq 871$	$0.025 \times (N-472) + 420.000$
	Downlink (BS, forward link)	$1536 \leq N \leq 1715$	$0.025 \times (N-1536) + 489.000$
	Downlink (BS, forward link)		
800 PAMR	Uplink (MS, reverse link)	$0 \leq N \leq 239$	$870.0125 + 0.025 \times N$
	Downlink (BS, forward link)	$0 \leq N \leq 239$	$915.0125 + 0.025 \times N$

LTE FDD Channel Number Ranges

The carrier frequency in the uplink and downlink is designated by the E-UTRA Absolute Radio Frequency Channel Number (EARFCN) in the range 0 – 65535. The relation between EARFCN and the carrier frequency in MHz for the downlink is given by the following equation, where FDL_low and NOffs-DL are given in table 5.4.4–1 and NDL is the downlink EARFCN.

$$FDL = FDL_low + 0.1(NDL - NOffs-DL)$$

The relation between EARFCN and the carrier frequency in MHz for the uplink is given by the following equation where FUL_low and NOffs-UL are given in table 5.4.4-1 and NUL is the uplink EARFCN.

$$FUL = FUL_low + 0.1(NUL - NOffs-UL)$$

Band	Downlink		Uplink			
	FDL_low (MHz)	NOffs-DL	Range of NDL	FUL_low (MHz)	NOffs-UL	Range of NUL
1		2110	0	0 - 599	1920	18000 - 18599
2		1930	600	600 - 1199	1850	18600 - 19199
3		1805	1200	1200 - 1949	1710	19200 - 19949
4		2110	1950	1950 - 2399	1710	19950 - 20399
5		869	2400	2400 - 2649	824	20400 - 20649
6		875	2650	2650 - 2749	830	20650 - 20749
7		2620	2750	2750 - 3449	2500	20750 - 20449
8		925	3450	3450 - 3799	880	21450 - 21799
9		1844.9	3800	3800 - 4149	1749.9	21800 - 22149
10		2110	4150	4150 - 4749	1710	22150 - 22749
11		1475.9	4750	4750 - 4949	1427.9	22750 - 22949
12		729	5010	5010 - 5179	699	23010 - 23179
13		746	5180	5180 - 5279	777	23180 - 23279
14		758	5280	5280 - 5379	788	23280 - 23379
...						
17		734	5730	5730 - 5849	704	23730 - 23849
18		860	5850	5850 - 5999	815	23850 - 23999
19		875	6000	6000 - 6149	830	24000 - 24149
20		791	6150	6150 - 6449	832	24150 -

Band	Downlink	Uplink				
						24449
21	1495.9	6450	6450 – 6599	1447.9	24450	24450 – 24599
...						
24	1525	7700	7700 – 8039	1626.5	25700	25700 – 26039
25	1930	8040	8040 – 8689	1850	26040	26040 – 26689
26	859	8690	8690 – 9039	814	26690	26690 – 27039
...						

Note: The channel numbers that designate carrier frequencies so close to the operating band edges that the carrier extends beyond the operating band edge shall not be used. This implies that the first 7, 15, 25, 50, 75 and 100 channel numbers at the lower operating band edge and the last 6, 14, 24, 49, 74 and 99 channel numbers at the upper operating band edge shall not be used for channel bandwidths of 1.4, 3, 5, 10, 15 and 20 MHz respectively.

LTE TDD Channel Number Ranges

The carrier frequency in the uplink and downlink is designated by the E-UTRA Absolute Radio Frequency Channel Number (EARFCN) in the range 0 – 65535. The relation between EARFCN and the carrier frequency in MHz for the downlink is given by the following equation, where FDL_low and NOffs-DL are given in table 5.4.4–1 and NDL is the downlink EARFCN.

$$FDL = FDL_low + 0.1(NDL - NOffs-DL)$$

The relation between EARFCN and the carrier frequency in MHz for the uplink is given by the following equation where FUL_low and NOffs-UL are given in table 5.4.4–1 and NUL is the uplink EARFCN.

$$FUL = FUL_low + 0.1(NUL - NOffs-UL)$$

Band	Downlink	Uplink				
FDL_low (MHz)	NOffs-DL	Range of NDL	FUL_low (MHz)	NOffs-UL	Range of NUL	
33	1900	36000	36000 – 36199	1900	36000	36000 – 36199
34	2010	36200	36200 – 36349	2010	36200	36200 – 36349
35	1850	36350	36350 – 36949	1850	36350	36350 – 36949
36	1930	36950	36950 – 37549	1930	36950	36950 – 37549
37	1910	37550	37550 – 37749	1910	37550	37550 – 37749

Band	Downlink	Uplink				
38	2570	37750	37750 - 38249	2570	37750	37750 - 38249
39	1880	38250	38250 - 38649	1880	38250	38250 - 38649
40	2300	38650	38650 - 39649	2300	38650	38650 - 39649
41	2496	39650	39650 - 41589	2496	39650	39650 - 41589
42	3400	41590	41590 - 43589	3400	41590	41590 - 43589
43	3600	43590	43590 - 45589	3600	43590	43590 - 45589

Note: The channel numbers that designate carrier frequencies so close to the operating band edges that the carrier extends beyond the operating band edge shall not be used. This implies that the first 7, 15, 25, 50, 75 and 100 channel numbers at the lower operating band edge and the last 6, 14, 24, 49, 74 and 99 channel numbers at the upper operating band edge shall not be used for channel bandwidths of 1.4, 3, 5, 10, 15 and 20 MHz respectively.

TDSCDMA Channel Number Ranges

1.28 Mcps TDD Option

No TX-RX frequency separation is required as Time Division Duplex (TDD) is employed. Each subframe consists of 7 main timeslots where all main timeslots (at least the first one) before the single switching point are allocated DL and all main timeslots (at least the last one) after the single switching point are allocated UL.

The nominal channel spacing is 1.6 MHz, but this can be adjusted to optimise performance in a particular deployment scenario.

The carrier frequency is designated by the UTRA absolute radio frequency channel number (UARFCN). The value of the UARFCN in the IMT2000 band is defined in the general case as follows:

$$N_t = 5 * F \quad 0.0 \text{ MHz} \leq F \leq 3276.6 \text{ MHz}$$

where F is the carrier frequency in MHz

Additional channels applicable to operation in the frequency band defined in sub-clause 5.2(d) are defined via the following UARFCN definition:

$$N_t = 5 * (F - 2150.1 \text{ MHz}) \quad 2572.5 \text{ MHz} \leq F \leq 2617.5 \text{ MHz}$$

UARFCN

1.28 Mcps TDD Option

The following UARFCN range shall be supported for each band:

**Table: UTRA Absolute Radio
Frequency Channel Number 1.28
Mcps TDD Option**

Frequency Band	Frequency Range	UARFCN Uplink and Downlink transmission
For operation in frequency band as defined in subclause 5.2 (a)	1900-1920 MHz	9504 to 9596
	2010-2025 MHz	10054 to 10121
For operation in frequency band as defined in subclause 5.2 (b)	1850-1910 MHz	9254 to 9546
	1930-1990 MHz	9654 to 9946
For operation in frequency band as defined in subclause 5.2 (c)	1910-1930 MHz	9554 to 9646
For operation in frequency band as defined in subclause 5.2 (d)	2570-2620 MHz	12854 to 13096
For operation in frequency band as defined in subclause 5.2 (e)	2300-2400 MHz	11504 to 11996
For operation in frequency band as defined in subclause 5.2 (f)	1880-1920 MHz	9404 to 9596

Radio Setup

Allows access to the sub-menus for selecting the radio standard and associated radio band. You can also set a frequency reference and offset.

This menu is greyed out when on E6630A. Radio band settings for GSM, cdma2000, and so on -- most of which are not actually supported in E6630A, which has three narrow frequency bands. So band settings are grayed out.

Key Path	Source, Frequency
Initial S/W Revision	A.05.00

Radio Standard

Allows access to the channel band sub-menus to select the desired radio standard. When you have selected the radio standard, you can then set an active channel band. The radio standard and the active channel band allow you to use channel numbers to set frequency automatically.

Key Path	Source, Frequency, Radio Setup
Remote Command	:SOURce:FREQuency:CHANnels:BAND NONE PGSM EGSM RGSM DCS1800 PCS1900 TGSM810 GSM450 GSM480 GSM700 GSM850 BANDI BANDII BANDIII BANDIV BANDV BANDVI BANDVII BANDVIII BANDIX BANDX BANDXI BANDXII BANDXIII BANDXIV BANDXIX USCELL USPCS JAPAN KOREAN NMT IMT2K UPPER SECOND PAMR400 PAMR800 IMTEXT PCS1DOT9G AWS US2DOT5G PUBLIC LOWER BAND1 BAND2 BAND3 BAND4 BAND5 BAND6 BAND7 BAND8 BAND10

BAND11 | BAND12 | BAND13 | BAND14 | BAND17 | BAND18 | BAND19 | BAND20 |
 BAND21 | BAND24 | BAND25 | BAND26 | BAND27 | BAND28 | BAND29 | BAND30 |
 BAND31 | BAND33 | BAND34 | BAND35 | BAND36 | BAND37 | BAND38 | BAND39 |
 BAND40 | BAND41 | BAND42 | BAND43 | BAND44 | BANDA | BANDB | BANDC |
 BANDD | BANDE | BANDF

:SOURce:FREQuency:CHANnels:BAND?

Example	:SOUR:FREQ:CHAN:BAND PGSM
Notes	Set this setting to "NONE" will grey out "Channel" on page 631 Channel
Initial S/W Revision	A.05.00

None

Selects no radio standard for use. When you have selected the radio standard to NONE, you cannot use channel numbers to set frequency automatically. You will need to set the frequency manually.

Key Path	Source, Frequency, Radio Setup, Radio Standard
Initial S/W Revision	A.05.00

GSM/EDGE

Sets GSM/EDGE as the radio standard for use and accesses the GSM/EDGE specific channel band sub-menu.

Key Path	Source, Frequency, Radio Setup, Radio Standard
Initial S/W Revision	A.05.00

P-GSM

Selects P-GSM as the active channel band.

Key Path	Source, Frequency, Radio Setup, Radio Standard, GSM/EDGE
Example	:SOUR:FREQ:CHAN:BAND PGSM
Initial S/W Revision	A.05.00

E-GSM

Selects E-GSM as the active channel band.

Key Path	Source, Frequency, Radio Setup, Radio Standard, GSM/EDGE
Example	:SOUR:FREQ:CHAN:BAND EGSM
Initial S/W Revision	A.05.00

R-GSM

Selects R-GSM as the active channel band.

Key Path	Source, Frequency, Radio Setup, Radio Standard, GSM/EDGE
Example	:SOUR:FREQ:CHAN:BAND RGSM
Initial S/W Revision	A.05.00

DCS 1800

Selects DCS 1800 as the active channel band.

Key Path	Source, Frequency, Radio Setup, Radio Standard, GSM/EDGE
Example	:SOUR:FREQ:CHAN:BAND DCS1800
Initial S/W Revision	A.05.00

PCS 1900

Selects PCS 1900 as the active channel band.

Key Path	Source, Frequency, Radio Setup, Radio Standard, GSM/EDGE
Example	:SOUR:FREQ:CHAN:BAND PCS1900
Initial S/W Revision	A.05.00

GSM 450

Selects GSM 450 as the active channel band.

Key Path	Source, Frequency, Radio Setup, Radio Standard, GSM/EDGE
Example	:SOUR:FREQ:CHAN:BAND GSM450
Initial S/W Revision	A.05.00

GSM 480

Selects GSM 480 as the active channel band.

Key Path	Source, Frequency, Radio Setup, Radio Standard, GSM/EDGE
Example	:SOUR:FREQ:CHAN:BAND GSM480
Initial S/W Revision	A.05.00

GSM 850

Selects GSM 850 as the active channel band.

Key Path	Source, Frequency, Radio Setup, Radio Standard, GSM/EDGE
Example	:SOUR:FREQ:CHAN:BAND GSM850
Initial S/W Revision	A.05.00

GSM 700

Selects GSM 700 as the active channel band.

Key Path	Source, Frequency, Radio Setup, Radio Standard, GSM/EDGE
Example	:SOUR:FREQ:CHAN:BAND GSM700
Initial S/W Revision	A.05.00

T-GSM 810

Selects T-GSM 810 as the active channel band.

Key Path	Source, Frequency, Radio Setup, Radio Standard, GSM/EDGE
Example	:SOUR:FREQ:CHAN:BAND T-GSM810
Initial S/W Revision	A.05.00

WCDMA

Sets WCDMA as the radio standard for use and accesses the W-CDMA specific channel band sub-menus.

Key Path	Source, Frequency, Radio Setup, Radio Standard
Initial S/W Revision	A.05.00

Band I

Selects Band I as the active channel band.

Key Path	Source, Frequency, Radio Setup, Radio Standard, WCDMA
Example	:SOUR:FREQ:CHAN:BAND BANDI
Initial S/W Revision	A.05.00

Band II

Selects Band II as the active channel band.

Key Path	Source, Frequency, Radio Setup, Radio Standard, WCDMA
Example	:SOUR:FREQ:CHAN:BAND BANDII
Initial S/W Revision	A.05.00

Band III

Selects Band III as the active channel band.

Key Path	Source, Frequency, Radio Setup, Radio Standard, WCDMA
Example	:SOUR:FREQ:CHAN:BAND BANDIII
Initial S/W Revision	A.05.00

Band IV

Selects Band IV as the active channel band.

Key Path	Source, Frequency, Radio Setup, Radio Standard, WCDMA
Example	:SOUR:FREQ:CHAN:BAND BANDIV
Initial S/W Revision	A.05.00

Band V

Selects Band V as the active channel band.

Key Path	Source, Frequency, Radio Setup, Radio Standard, WCDMA
Example	:SOUR:FREQ:CHAN:BAND BANDV
Initial S/W Revision	A.05.00

Band VI

Selects Band VI as the active channel band.

Key Path	Source, Frequency, Radio Setup, Radio Standard, WCDMA
Example	:SOUR:FREQ:CHAN:BAND BANDVI
Initial S/W Revision	A.05.00

Band VII

Selects Band VII as the active channel band.

Key Path	Source, Frequency, Radio Setup, Radio Standard, WCDMA
Example	:SOUR:FREQ:CHAN:BAND BANDVII
Initial S/W Revision	A.05.00

Band VIII

Selects Band VIII as the active channel band.

Key Path	Source, Frequency, Radio Setup, Radio Standard, WCDMA
Example	:SOUR:FREQ:CHAN:BAND BANDVIII
Initial S/W Revision	A.05.00

Band IX

Selects Band IX as the active channel band.

Key Path	Source, Frequency, Radio Setup, Radio Standard, WCDMA
Example	:SOUR:FREQ:CHAN:BAND BANDIX
Initial S/W Revision	A.05.00

Band X

Selects Band X as the active channel band.

Key Path	Source, Frequency, Radio Setup, Radio Standard, WCDMA
Example	:SOUR:FREQ:CHAN:BAND BANDX
Initial S/W Revision	A.05.00

Band XI

Selects Band XI as the active channel band.

Key Path	Source, Frequency, Radio Setup, Radio Standard, WCDMA
Example	:SOUR:FREQ:CHAN:BAND BANDXI
Initial S/W Revision	A.05.00

Band XII

Selects Band XII as the active channel band.

Key Path	Source, Frequency, Radio Setup, Radio Standard, WCDMA
Example	:SOUR:FREQ:CHAN:BAND BANDXII
Initial S/W Revision	A.05.00

Band XIII

Selects band XIII as the active channel band.

Key Path	Source, Frequency, Radio Setup, Radio Standard, WCDMA
Example	:SOUR:FREQ:CHAN:BAND BANDXIII
Initial S/W Revision	A.05.00

Band XIV

Selects Band XIV as the active channel band.

Key Path	Source, Frequency, Radio Setup, Radio Standard, WCDMA
Example	:SOUR:FREQ:CHAN:BAND BANDXIV
Initial S/W Revision	A.05.00

CDMA 2000 / 1xEVDO

Sets CDMA 2000 / 1XEVDO as the radio standard for use and accesses the CDMA 2000/1xEVDO specific channel band sub-menus.

Key Path	Source, Frequency, Radio Setup, Radio Standard
Initial S/W Revision	A.05.00

US CELL

Selects US Cell as the active channel band.

Key Path	Source, Frequency, Radio Setup, Radio Standard, CDMA 2000 / 1xEVDO
Example	:SOUR:FREQ:CHAN:BAND USCELL
Initial S/W Revision	A.05.00

US PCS

Selects US PCS as the active channel band.

Key Path	Source, Frequency, Radio Setup, Radio Standard, CDMA 2000 / 1xEVDO
Example	:SOUR:FREQ:CHAN:BAND PCS
Initial S/W Revision	A.05.00

Japan Cell

Selects Japan Cell as the active channel band.

Key Path	Source, Frequency, Radio Setup, Radio Standard, CDMA 2000 / 1xEVDO
Example	:SOUR:FREQ:CHAN:BAND JAPAN
Initial S/W Revision	A.05.00

Korean PCS

Selects Korean PCS as the active channel band.

Key Path	Source, Frequency, Radio Setup, Radio Standard, CDMA 2000 / 1xEVDO
Example	:SOUR:FREQ:CHAN:BAND KOREAN
Initial S/W Revision	A.05.00

NMT 450

Selects NMT 450 as the active channel band.

Key Path	Source, Frequency, Radio Setup, Radio Standard, CDMA 2000 / 1xEVDO
Example	:SOUR:FREQ:CHAN:BAND NMT
Initial S/W Revision	A.05.00

IMT 2000

Selects IMT 2000 as the active channel band.

Key Path	Source, Frequency, Radio Setup, Radio Standard, CDMA 2000 / 1xEVDO
Example	:SOUR:FREQ:CHAN:BAND IMT2K
Initial S/W Revision	A.05.00

Upper 700

Selects Upper 700 as the active channel band.

Key Path	Source, Frequency, Radio Setup, Radio Standard, CDMA 2000 / 1xEVDO
Example	:SOUR:FREQ:CHAN:BAND UPPER
Initial S/W Revision	A.05.00

Secondary 800

Selects Secondary 800 as the active channel band.

Key Path	Source, Frequency, Radio Setup, Radio Standard, CDMA 2000 / 1xEVDO
Example	:SOUR:FREQ:CHAN:BAND SECOND
Initial S/W Revision	A.05.00

400 Euro PAMR

Selects 400 Euro PAMR as the active channel band.

Key Path	Source, Frequency, Radio Setup, Radio Standard, CDMA 2000 / 1xEVDO
Example	:SOUR:FREQ:CHAN:BAND PAMR400
Initial S/W Revision	A.05.00

800 PAMR

Selects 800 PAMR as the active channel band.

Key Path	Source, Frequency, Radio Setup, Radio Standard, CDMA 2000 / 1xEVDO
Example	:SOUR:FREQ:CHAN:BAND PAMR800
Initial S/W Revision	A.05.00

2.5GHz IMT EXT

Selects 2.5 GHz IMT EXT as the active channel band.

Key Path	Source, Frequency, Radio Setup, Radio Standard, CDMA 2000 / 1xEVDO
Example	:SOUR:FREQ:CHAN:BAND IMTEXT
Initial S/W Revision	A.05.00

US PCS 1.9GHz

Selects US PCS 1.9 GHz as the active channel band.

Key Path	Source, Frequency, Radio Setup, Radio Standard, CDMA 2000 / 1xEVDO
Example	:SOUR:FREQ:CHAN:BAND PCS1DOT9G
Initial S/W Revision	A.05.00

AWS

Selects AWS as the active channel band.

Key Path	Source, Frequency, Radio Setup, Radio Standard, CDMA 2000 / 1xEVDO
Example	:SOUR:FREQ:CHAN:BAND AWS
Initial S/W Revision	A.05.00

US 2.5GHz

Selects US 2.5 GHz as the active channel band.

Key Path	Source, Frequency, Radio Setup, Radio Standard, CDMA 2000 / 1xEVDO
Example	:SOUR:FREQ:CHAN:BAND US2DOT5G
Initial S/W Revision	A.05.00

700 Public Safety

Selects 700 Public Safety as the active channel band.

Key Path	Source, Frequency, Radio Setup, Radio Standard, CDMA 2000 / 1xEVDO
Example	:SOUR:FREQ:CHAN:BAND PUBLIC
Initial S/W Revision	A.05.00

C2K Lower 700

Selects C2K Lower 700 as the active channel band.

Key Path	Source, Frequency, Radio Setup, Radio Standard, CDMA 2000 / 1xEVDO
Example	:SOUR:FREQ:CHAN:BAND LOWER
Initial S/W Revision	A.05.00

LTE

Sets LTE FDD as the radio standard for use and accesses the LTE FDD specific channel band sub-menus..

Key Path	Source, Frequency, Radio Setup, Radio Standard
Initial S/W Revision	A.09.50

BAND 1

Selects BAND 1 as the band for the current step.

Key Path	Source, Frequency, Radio Setup, Radio Standard, LTE
Example	:SOUR:FREQ:CHAN:BAND BAND1
Initial S/W Revision	A.09.50

BAND 2

Selects BAND 2 as the band for the current step.

Key Path	Source, Frequency, Radio Setup, Radio Standard, LTE
Example	:SOUR:FREQ:CHAN:BAND BAND2
Initial S/W Revision	A.09.50

BAND 3

Selects BAND 3 as the band for the current step.

Key Path	Source, Frequency, Radio Setup, Radio Standard, LTE
Example	:SOUR:FREQ:CHAN:BAND BAND3
Initial S/W Revision	A.09.50

BAND 4

Selects BAND 4 as the band for the current step.

Key Path	Source, Frequency, Radio Setup, Radio Standard, LTE
Example	:SOUR:FREQ:CHAN:BAND BAND4
Initial S/W Revision	A.09.50

BAND 5

Selects BAND 5 as the band for the current step.

Key Path	Source, Frequency, Radio Setup, Radio Standard, LTE
----------	--

Example	:SOUR:FREQ:CHAN:BAND BAND5
Initial S/W Revision	A.09.50

BAND 6

Selects BAND 6 as the band for the current step.

Key Path	Source, Frequency, Radio Setup, Radio Standard, LTE
Example	:SOUR:FREQ:CHAN:BAND BAND6
Initial S/W Revision	A.09.50

BAND 7

Selects BAND 7 as the band for the current step.

Key Path	Source, Frequency, Radio Setup, Radio Standard, LTE
Example	:SOUR:FREQ:CHAN:BAND BAND7
Initial S/W Revision	A.09.50

BAND 8

Selects BAND 8 as the band for the current step.

Key Path	Source, Frequency, Radio Setup, Radio Standard, LTE
Example	:SOUR:FREQ:CHAN:BAND BAND8
Initial S/W Revision	A.09.50

BAND 9

Selects BAND 9 as the band for the current step.

Key Path	Source, Frequency, Radio Setup, Radio Standard, LTE
Example	:SOUR:FREQ:CHAN:BAND BAND9
Initial S/W Revision	A.09.50

BAND 10

Selects BAND 10 as the band for the current step.

Key Path	Source, Frequency, Radio Setup, Radio Standard, LTE
----------	--

Example	:SOUR:FREQ:CHAN:BAND BAND10
Initial S/W Revision	A.09.50

BAND 11

Selects BAND 11 as the band for the current step.

Key Path	Source, Frequency, Radio Setup, Radio Standard, LTE
Example	:SOUR:FREQ:CHAN:BAND BAND11
Initial S/W Revision	A.09.50

BAND 12

Selects BAND 12 as the band for the current step.

Key Path	Source, Frequency, Radio Setup, Radio Standard, LTE
Example	:SOUR:FREQ:CHAN:BAND BAND12
Initial S/W Revision	A.09.50

BAND 13

Selects BAND 13 as the band for the current step.

Key Path	Source, Frequency, Radio Setup, Radio Standard, LTE
Example	:SOUR:FREQ:CHAN:BAND BAND13
Initial S/W Revision	A.09.50

BAND 14

Selects BAND 14 as the band for the current step.

Key Path	Source, Frequency, Radio Setup, Radio Standard, LTE
Example	:SOUR:FREQ:CHAN:BAND BAND14
Initial S/W Revision	A.09.50

BAND 17

Selects BAND 17 as the band for the current step.

Key Path	Source, Frequency, Radio Setup, Radio Standard, LTE
----------	--

Example	:SOUR:FREQ:CHAN:BAND BAND17
Initial S/W Revision	A.09.50

BAND 18

Selects BAND 18 as the band for the current step.

Key Path	Source, Frequency, Radio Setup, Radio Standard, LTE
Example	:SOUR:FREQ:CHAN:BAND BAND18
Initial S/W Revision	A.09.50

BAND 19

Selects BAND 19 as the band for the current step.

Key Path	Source, Frequency, Radio Setup, Radio Standard, LTE
Example	:SOUR:FREQ:CHAN:BAND BAND19
Initial S/W Revision	A.09.50

BAND 20

Selects BAND 20 as the band for the current step.

Key Path	Source, Frequency, Radio Setup, Radio Standard, LTE
Example	:SOUR:FREQ:CHAN:BAND BAND20
Initial S/W Revision	A.09.50

BAND 21

Selects BAND 21 as the band for the current step.

Key Path	Source, Frequency, Radio Setup, Radio Standard, LTE
Example	:SOUR:FREQ:CHAN:BAND BAND21
Initial S/W Revision	A.09.50

BAND 24

Selects BAND 24 as the band for the current step.

Key Path	Source, Frequency, Radio Setup, Radio Standard, LTE
----------	--

Example	:SOUR:FREQ:CHAN:BAND BAND24
Initial S/W Revision	A.09.50

BAND 25

Selects BAND 25 as the band for the current step.

Key Path	Source, Frequency, Radio Setup, Radio Standard, LTE
Example	:SOUR:FREQ:CHAN:BAND BAND25
Initial S/W Revision	A.09.50

BAND 26

Selects BAND 26 as the band for the current step.

Key Path	Source, Frequency, Radio Setup, Radio Standard, LTE
Example	:SOUR:FREQ:CHAN:BAND BAND26
Initial S/W Revision	A.12.53

BAND 27

Selects BAND 27 as the band for the current step.

Key Path	Source, Frequency, Radio Setup, Radio Standard, LTE
Example	:SOUR:FREQ:CHAN:BAND BAND27
Initial S/W Revision	A.14.00

BAND 28

Selects BAND 28 as the band for the current step.

Key Path	Source, Frequency, Radio Setup, Radio Standard, LTE
Example	:SOUR:FREQ:CHAN:BAND BAND28
Initial S/W Revision	A.14.00

BAND 31

Selects BAND 31 as the band for the current step.

Key Path	Source, Frequency, Radio Setup, Radio Standard, LTE
----------	--

Example	:SOUR:FREQ:CHAN:BAND BAND31
Initial S/W Revision	A.14.00

LTE TDD

Sets LTE TDD as the radio standard for use and accesses the LTE TDD specific channel band sub-menus..

Key Path	Source, Frequency, Radio Setup, Radio Standard
Initial S/W Revision	A.11.50

BAND 33

Selects BAND 33 as the band for the current step.

Key Path	Source, Frequency, Radio Setup, Radio Standard, LTE TDD
Example	:SOUR:FREQ:CHAN:BAND BAND33
Initial S/W Revision	A.11.50

BAND 34

Selects BAND 34 as the band for the current step.

Key Path	Source, Frequency, Radio Setup, Radio Standard, LTE TDD
Example	:SOUR:FREQ:CHAN:BAND BAND34
Initial S/W Revision	A.11.50

BAND 35

Selects BAND 35 as the band for the current step.

Key Path	Source, Frequency, Radio Setup, Radio Standard, LTE TDD
Example	:SOUR:FREQ:CHAN:BAND BAND35
Initial S/W Revision	A.11.50

BAND 36

Selects BAND 36 as the band for the current step.

Key Path	Source, Frequency, Radio Setup, Radio Standard, LTE TDD
Example	:SOUR:FREQ:CHAN:BAND BAND36
Initial S/W Revision	A.11.50

BAND 37

Selects BAND 37 as the band for the current step.

Key Path	Source, Frequency, Radio Setup, Radio Standard, LTE TDD
Example	:SOUR:FREQ:CHAN:BAND BAND37
Initial S/W Revision	A.11.50

BAND 38

Selects BAND 38 as the band for the current step.

Key Path	Source, Frequency, Radio Setup, Radio Standard, LTE TDD
Example	:SOUR:FREQ:CHAN:BAND BAND38
Initial S/W Revision	A.11.50

BAND 39

Selects BAND 39 as the band for the current step.

Key Path	Source, Frequency, Radio Setup, Radio Standard, LTE TDD
Example	:SOUR:FREQ:CHAN:BAND BAND39
Initial S/W Revision	A.11.50

BAND 40

Selects BAND 40 as the band for the current step.

Key Path	Source, Frequency, Radio Setup, Radio Standard, LTE TDD
Example	:SOUR:FREQ:CHAN:BAND BAND40
Initial S/W Revision	A.11.50

BAND 41

Selects BAND 41 as the band for the current step.

Key Path	Source, Frequency, Radio Setup, Radio Standard, LTE TDD
Example	:SOUR:FREQ:CHAN:BAND BAND41
Initial S/W Revision	A.11.50

BAND 42

Selects BAND 42 as the band for the current step.

Key Path	Source, Frequency, Radio Setup, Radio Standard, LTE TDD
Example	:SOUR:FREQ:CHAN:BAND BAND42
Initial S/W Revision	A.11.50

BAND 43

Selects BAND 43 as the band for the current step.

Key Path	Source, Frequency, Radio Setup, Radio Standard, LTE TDD
Example	:SOUR:FREQ:CHAN:BAND BAND43
Initial S/W Revision	A.11.50

BAND 44

Selects BAND 44 as the band for the current step.

Key Path	Source, Frequency, Radio Setup, Radio Standard, LTE TDD
Example	:SOUR:FREQ:CHAN:BAND BAND44
Initial S/W Revision	A.14.00

TDSCDMA

Sets TDSCDMA as the radio standard for use and accesses the TDSCDMA specific channel band sub-menus..

Key Path	Source, Frequency, Radio Setup, Radio Standard
Initial S/W Revision	A.11.50

BAND A

Selects BAND A as the band for the current step.

Key Path	Source, Frequency, Radio Setup, Radio Standard, TDSCDMA
Example	:SOUR:FREQ:CHAN:BAND BANDA
Initial S/W Revision	A.11.50

BAND B

Selects BAND B as the band for the current step.

Key Path	Source, Frequency, Radio Setup, Radio Standard, TDSCDMA
Example	:SOUR:FREQ:CHAN:BAND BANDB
Initial S/W Revision	A.11.50

BAND C

Selects BAND C as the band for the current step.

Key Path	Source, Frequency, Radio Setup, Radio Standard, TDSCDMA
Example	:SOUR:FREQ:CHAN:BAND BANDC
Initial S/W Revision	A.11.50

BAND D

Selects BAND D as the band for the current step.

Key Path	Source, Frequency, Radio Setup, Radio Standard, TDSCDMA
Example	:SOUR:FREQ:CHAN:BAND BANDD
Initial S/W Revision	A.11.50

BAND E

Selects BAND E as the band for the current step.

Key Path	Source, Frequency, Radio Setup, Radio Standard, TDSCDMA
Example	:SOUR:FREQ:CHAN:BAND BANDE
Initial S/W Revision	A.11.50

BAND F

Selects BAND F as the band for the current step.

Key Path	Source, Frequency, Radio Setup, Radio Standard, TDSCDMA
Example	:SOUR:FREQ:CHAN:BAND BANDF
Initial S/W Revision	A.11.50

Radio Band Link

Allows you to specify the channel band type as either uplink or downlink link direction. This value is used in conjunction with the channel band and channel number to determine the absolute frequency output by the

source. When set to “Uplink”, the source will calculate the uplink frequency using an uplink formula together with the selected channel band and channel number . When set to “Downlink”, the source will calculate the downlink frequency using a downlink formula together with the selected channel band and channel number.

Key Path	Source, Frequency, Radio Setup
Remote Command	:SOURce:RADio:BAND:LINK DOWN UP :SOURce:RADio:BAND:LINK?
Example	:SOUR:RAD:BAND:LINK UP
Preset	DOWN
Range	DOWN UP
Backwards Compatibility SCPI	:SOURce:RADio:DEVIce BTS MS :SOURce:RADio:DEVIce?
Backwards Compatibility Notes	BTS maps to the Downlink frequency MS maps to the Uplink frequency
Initial S/W Revision	A.05.00

Set Reference Frequency

This key allows you to set the frequency reference. Pressing this key turns the frequency reference state to ON, sets the reference frequency value to the current frequency, maintains this frequency at the RF output, and sets the displayed frequency to 0.00 Hz. All subsequent frequencies entered under Source>Frequency>Frequency are interpreted as being relative to this reference frequency.

When you use a frequency reference, the signal generator outputs a frequency that is set relative to the reference frequency by the value entered under Source>Frequency>Frequency as follows:

Output frequency = reference frequency - entered frequency

Where:

reference frequency equals the original RF frequency entered under Source>Frequency>Frequency and set as the reference frequency

entered frequency equals a new value entered under Source>Frequency>Frequency

In addition, the displayed frequency value will be the same as the value entered under Source>Frequency>Frequency.

NOTE

If Freq Reference is set to ON with a reference value set, entering a value under Source>Frequency>Frequency and pressing Set Frequency Reference will add that value to the existing Freq Reference value.

If you wish to change the reference frequency value to the new value entered under Source>Frequency>Frequency, first you must set Freq Reference to OFF and then press Set Frequency Reference.

Key Path	Source, Frequency
-----------------	--------------------------

Remote Command	:SOURce:FREQuency:REFerence:SET
Example	:SOUR:FREQ:REF:SET
Dependencies	This setting is unavailable, and is grayed out when the List Sequencer is turned ON.
Initial S/W Revision	A.05.00

Freq Reference

This key allows you to toggle the state of the frequency reference. When the frequency reference state is ON, an annunciator is displayed on the main source view to indicate this state to the user.

When you use a frequency reference, the signal generator outputs a frequency that is set relative to the reference frequency by the value entered under Source>Frequency>Frequency as follows:

Output frequency = reference frequency + entered frequency

Where:

reference frequency equals the original RF frequency entered under Source>Frequency>Frequency and set as the reference frequency

entered frequency equals a new value entered under Source>Frequency>Frequency

For more information on Reference Frequency refer to ["Set Reference Frequency" on page 659](#)

Key Path	Source, Frequency
Remote Command	:SOURce:FREQuency:REFerence <freq> :SOURce:FREQuency:REFerence? :SOURce:FREQuency:REFerence:STATe OFF ON 0 1 :SOURce:FREQuency:REFerence:STATe?
Example	:SOUR:FREQ:REF 0.00 Hz :SOUR:FREQ:REF:STATe ON
Dependencies	This setting is unavailable, and is grayed out when the List Sequencer is turned ON.
Couplings	The frequency reference state is coupled to the frequency reference set immediate action. When the reference set immediate action key is pressed, or the SCPI command issued, it turns the frequency reference state ON.
Preset	0.00 Hz OFF
Min	0.00 Hz
Max	Hardware Dependant: Option 503 = 3.6 GHz Option 504 = 3.8 GHz Option 506 = 6.00 GHz
Initial S/W Revision	A.05.00

Freq Offset

Allows you to specify the frequency offset value. When the frequency offset state is ON, an annunciator is displayed on the main source view to indicate this state to the user.

When the frequency offset is set to zero (0) and you set a new offset value, the displayed frequency value will change as follows and the RF output frequency will not change:

Displayed value = output frequency + offset value

Where:

output frequency equals the original frequency entered under Source>Frequency>Frequency

offset value equals the value entered under Source>Frequency>Freq Offset

When the frequency offset is set to a value other than zero (0) and you enter a new frequency value under Source>Frequency>Frequency, the displayed frequency will be the same as the value entered and the RF output frequency will be equal to the value entered minus the offset value as follows:

Output frequency = entered frequency – offset frequency

Displayed frequency = output frequency + offset frequency

Displayed frequency = entered frequency

Where:

entered frequency equals the frequency entered under Source>Frequency>Frequency

offset frequency equals the value previously entered and set under Source>Frequency>Freq Offset

Key Path	Source, Frequency
Remote Command	:SOURce:FREQuency:OFFSet <freq> :SOURce:FREQuency:OFFSet?
Example	:SOUR:FREQ:OFFS 0 Hz
Dependencies	This setting is unavailable, and is grayed out when the List Sequencer is turned ON.
Preset	0 Hz
Min	-100.00 GHz
Max	100.00 GHz
Initial S/W Revision	A.05.00

Modulation Setup

Allows access to the menus for setting up the available modulation types: "ARB" on page 662, "AM" on page 708, "FM" on page 710, and "PM" on page 711.

Key Path	Source
Initial S/W Revision	A.05.00

ARB

Allows you access to the ARB sub-menus.

Key Path	Source, Modulation Setup
Initial S/W Revision	A.05.00

ARB

Allows you to toggle the state of the ARB function. When the ARB is On, a “MOD” annunciator is displayed in the system settings panel. When the ARB is turned Off, the MOD annunciator is cleared

Key Path	Source, Modulation Setup, ARB
Remote Command	:SOURce:RADio:ARB[:STATe] ON OFF 1 0 :SOURce:RADio:ARB[:STATe]?
Example	:SOUR:RAD:ARB OFF :SOUR:RAD:ARB?
Notes	If the ARB is ON, a user then loads or deletes another file to ARB memory, the playing waveform segment may not keep phase continuity during the ARB memory operation. The waveform will be replayed after the ARB operation is finished.
Dependencies	This setting is for independent mode and has no effect on 3.3.8 list sequencer mode. Setting "Sequencer" on page 713 Sequencer to On will put source enter list sequencer mode, and even if ARB state is On, the ARB file will not be played. Setting "Sequencer" on page 713 Sequencer to Off will make source leave list sequencer mode, and this setting will take effect immediately. The ARB can only be turned on when there is a waveform file selected for playback. On the GUI if no waveform is selected, this key is grayed out. If you send the SCPI command to turn the ARB on with no waveform selected for playback, the ARB state remains OFF and an error is generated. "- When you try to recall a certain set of states in which the selected waveform is not in ARB memory and the ARB state is On, errors are reported
Couplings	If "Real-Time AWGN" on page 673 AWGN State is On and this setting is On, "RF Power" on page 627 RF Power will be adjusted to the value to maintain the AWGN power relationship defined by "Power Control Mode" on page 674 Power Control Mode and other noise settings
Preset	Off
Range	On Off
Initial S/W Revision	A.05.00
Modified at S/W Revision	A.16.00 (Add couplings with AWGN state)

Select Waveform

Allows you to access to the waveform selection sub-menus.

Pressing this key changes the central view area to show the Waveform File Selection view.

Key Path	Source, Modulation Setup, ARB
Initial S/W Revision	A.05.00

Select Waveform

Allows you to select a waveform sequence or segment for the dual ARB to play.

Key Path	Source, Modulation Setup, ARB, Select Waveform
Remote Command	:SOURce:RADio:ARB:WAVeform <string> :SOURce:RADio:ARB:WAVeform?
Example	:SOUR:RAD:ARB:WAV "test_waveform.bin"
Notes	<p>If intended waveform is not in the memory yet, then issuing this command by SCPI will invoke ARB loading operation first, which involves a delay of unpredictable length. So this command should be followed by the query *OPC?, which holds off subsequent commands until the loading operating is complete.</p> <p><string> - specifies the name of the waveform segment or waveform sequence to be played by the ARB.</p> <p>When in Sequence Analyzer mode, and Include Source is Yes, if the you attempt to play a waveform sequence but not all the required waveform segments are in the ARB playback memory, the application will reject the loading operation with an error is generated .</p> <p>When Include Source is No, if you attempt to play a waveform sequence but not all the required waveform segments are contained in the ARB playback memory, the application will attempt to load the required segments from either the default directory of the current directory. If the ARB memory does not have enough space for all the waveform segments to be loaded, an error is generated and none of the waveform segments is loaded.</p> <p>If the ARB is ON, and you attempt to play a waveform sequence but not all the waveform segments within the sequence could be found to be loaded into ARB memory, an error is generated. The selected waveform keeps the previous value and ARB state remains On.</p> <p>If you specify a waveform segment over SCPI but the waveform segment is not present within ARB playback memory and cannot be found for auto loading within the current directory or the default directory, an error is generated and the file selection remains unchanged.</p> <p>If you select a waveform for playback and the waveform requires a license that is not installed on the instrument, an error is generated.error is generated.</p> <p>If the ARB is ON and you load a file to ARB memory or delete a file from ARB memory, the playing waveform segment may not keep phase continuity during the ARB memory operation. The waveform will be replayed after the ARB operation is finished.</p>
Initial S/W Revision	A.05.00

Segments on Hard Disk

Allows you access to the sub-menus for loading waveform segments from the hard disk into ARB memory. The default directory is: D: varb.

Pressing this key changes the current view to the Waveform Management View.

Key Path	Source, Modulation Setup, ARB, Select Waveform
Initial S/W Revision	A.05.00

Load Segment To ARB Memory

Allows you to load the selected file into ARB memory. On the front panel you select the file for loading to the ARB memory by highlighting the desired file in the list. Using the SCPI command, you specify the file name on the HDD.

“NVWFM” (none-volatile storage) MSUS (Mass Storage Unit Specifier) is supported in the memory subsystem because the ARB memory cannot be accessed directly. Therefore, files must be downloaded to the instrument hard disk and then loaded into the ARB memory. “NVWFM” MSUS will be mapped to the default directory D: VARB. The SCPI command supports using either “NVWFM” MSUS or specifying a full path. For more information, see [Memory Subsystem \(Remote Command Only\)](#).

If a file of the same name already exists within ARB memory, it is overwritten. If you wish to load two segments of the same name, you must rename one of the segments before loading it into ARB memory. To rename a segment, you can either use Windows File Explorer, or the :MMEMory:COPI command.

Key Path	Source, Modulation Setup, ARB, Select Waveform, Segments on Hard Disk
Remote Command	:SOURce:RADio:ARB:LOAD <string>
Example	:SOUR:RAD:ARB:LOAD "D: VARB\testwaveform.bin" or :SOUR:RAD:ARB:LOAD "NVWFM:testwaveform.bin"
Notes	<p>Because loading the file involves a delay of unpredictable length, this command should be followed by the query *OPC?, which holds off subsequent commands until the loading operating is complete.</p> <p><string> - specifies the path name of the file to load from the HDD into ARB memory. It could be a <full path + filename>, or <"NVWFM" MSUS + colon + filename>.</p> <p>When in Sequence Analyzer mode, and Include Source is Yes, an attempt to load a file to ARB memory will be rejected with an error.</p> <p>When Include Source is No and if there is insufficient free ARB memory to load the selected waveform, an error is generated. .</p> <p>If you specify a file over SCPI, but the file is not at the specified location, an error is generated.</p> <p>If you try to load a waveform file but the file contains less than 500 IQ samples, an error is generated.</p> <p>If you try to load a Signal Studio waveform "*.wfm" which contains invalid waveform header, an error is generated.</p> <p>If the ARB is ON when you load a file to ARB memory or delete a file from ARB memory, the playing waveform segment may not keep phase continuity during the ARB memory operation. The waveform will be replayed after the ARB operation is finished.</p> <p>ARB can be loaded into ARB memory even required licenses do not present on the instrument. In this</p>

case, a GUI only warning message -800, "Operation complete; Loaded <filename> successfully, but no license <required licenses> installed". User can install required licenses according to <required licenses> string to license it, or multi-pack license it.

Initial S/W Revision	A.05.00
----------------------	---------

Load All To ARB Memory

Allows you to load all the segment files within the currently selected directory into ARB memory. If a file of the same name already exists within ARB memory, it is overwritten. If you wish to load two segments of the same name, you must rename one of the segments before loading it into ARB memory. To rename a segment, you can either use Windows File Explorer, or the :MEMory:COpy command.

Key Path	Source, Modulation Setup, ARB, Select Waveform, Segments on Hard Disk
Remote Command	:SOURce:RADio:ARB:LOAD:ALL <string>
Example	:SOUR:RAD:ARB:LOAD:ALL "D: varb"
Notes	<p><string> - specifies the directory on the HDD to load the files into ARB memory from.</p> <p>When in Sequence Analyzer mode, and Include Source is Yes, an attempt to load all files from a directory to ARB memory is rejected with an error.</p> <p>When Include Source is No and there is insufficient free ARB memory to load all the waveforms, when the ARB memory is full, the copy ceases, and an error is generated.</p> <p>If you specify a directory over SCPI, but the directory does not exist, an error is generated.</p> <p>If the ARB is ON, a user then loads or deletes file to ARB memory, the playing waveform segment may not keep phase continuity during the ARB memory operation. The waveform will be replayed after the ARB operation is finished.</p>
Initial S/W Revision	A.05.00

Change Directory...

Allows you to change the currently selected directory on the hard disk. Pressing this key opens a standard windows change directory dialog allowing you to select the new directory of interest.

The current directory is used for manually loading waveform segments into ARB memory for playback, and as a search location for waveform segments that are required to be loaded into ARB memory for playback of a waveform sequence or a list sequence.

Key Path	Source, Modulation Setup, ARB, Select Waveform, Segments on Hard Disk
Notes	No remote command, SCPIfront panel only.
Initial S/W Revision	A.05.00

Default Directory...

Allows you to change the default directory. It is used as a search location for waveform segments that are required to be loaded into ARB memory for playback of a waveform sequence, and as a search location for

selecting waveforms using SCPI.

Key Path	Source, Modulation Setup, ARB, Select Waveform, Segments on Hard Disk
Remote Command	:SOURce:RADio:ARB:DEFault:DIRectory <string> :SOURce:RADio:ARB: DEFault:DIRectory?
Example	:SOUR:RAD:ARB:DEF:DIR "D:\ArbFiles" :SOUR:RAD:ARB:DEF:DIR?
State Saved	Persistent, survives a power cycle and a preset but not saved in the instrument state
Initial S/W Revision	A.05.00

Segments in ARB Memory

Allows you access to the sub-menus for managing the files within ARB memory.

Key Path	Source, Modulation Setup, ARB, Select Waveform
Initial S/W Revision	A.05.00

Delete Segment From ARB Mem

Allows you to remove a segment from ARB playback memory.

Key Path	Source, Modulation Setup, ARB, Select Waveform, Segments in ARB Memory
Remote Command	:SOURce:RADio:ARB:DELete <string>
Example	:SOUR:RAD:ARB:DEL "testwaveform.bin"
Notes	<p><string> - specifies the waveform to be deleted from the ARB playback memory.</p> <p>When in Sequence Analyzer mode and Include Source is Yes, an attempt to delete a file from ARB memory is rejected with an error.</p> <p>When Include Source is No and you specify a file that does not exist within ARB memory, an error is generated.</p> <p>It is possible to delete files from within the ARB memory when the ARB is ON. However, if you attempt to delete the file that is currently playing an error is generated.</p> <p>It is possible to delete a file from within the ARB memory when the sequencer state is ON and the file is not being used by the List Sequencer. If you attempt to delete a file which is being used by the list sequencer, an error is generated.</p> <p>When sequencer state is On, even if ARB state is On, the selected waveform will not be played. In this case, if the selected waveform is not used in List Sequence, it can be deleted and the ARB state is turned Off.</p> <p>If the ARB is ON and you load a file to ARB memory or delete a file from ARB memory, the playing waveform segment may not keep phase continuity during the ARB memory operation. The waveform will be replayed after the ARB operation is finished.</p>
Initial S/W Revision	A.05.00

Delete All From ARB Memory

Allows you to remove all segments from ARB playback memory.

Key Path	Source, Modulation Setup, ARB, Select Waveform, Segments in ARB Memory
Remote Command	:SOURce:RADio:ARB:DELeTe:ALL
Example	:SOUR:RAD:ARB:DELeTe:ALL
Notes	<p>When in Sequence Analyzer mode and Include Source is Yes, an attempt to delete all files from ARB memory is rejected with an error.</p> <p>When Include Source is No and you attempt to delete all files from ARB memory when the ARB is currently playing a file, all files except the one playing are deleted and an error is generated.</p> <p>If you attempt to delete all files from ARB memory when there are waveform files used in "List Sequencer" on page 712 and "Sequencer" on page 713 state is ON, all files except the files currently being used in list sequencer are deleted, and an error is generated.</p> <p>If the ARB is ON and you load a file to ARB memory or delete a file from ARB memory, the playing waveform segment may not keep phase continuity during the ARB memory operation. The waveform will be replayed after the ARB operation is finished.</p>
Initial S/W Revision	A.05.00

Query ARB Memory File List (Remote Command Only)

Queries the test set for the list of waveform segments in the ARB memory.

NOTE

This command returns a string for waveform segment names in ARB memory. If you want a string list of waveform segments in the ARB memory, use "[Query ARB Memory Full File List \(Remote Command Only\)](#)" on page 667.

Remote Command	:SOURce:RADio:ARB:CATalog?
Example	:SOUR:RAD:ARB:CATalog?
Notes	<p>The return data is in the following format:</p> <p><integer> - memory used</p> <p><integer> - memory free</p> <p><string> ... - comma separated list of waveform segments within ARB memory</p>
Initial S/W Revision	A.05.00

Query ARB Memory Full File List (Remote Command Only)

Queries the test set for the string list of waveform segments in the ARB memory. It returns a string list for waveform segment names in the ARB memory.

Remote Command	:SOURce:RADio:ARB:FCATalog?
Example	:SOUR:RAD:ARB:FCATalog?
Notes	<p>The return data is in the following format:</p> <p><integer> - memory used</p>

	<p><integer> - memory free <integer> - file count in ARB memory <string>, <string>, ... <string> - comma separated string list of waveform segments within ARB memory Example: SOUR:RAD:ARB:FCAT? EXT returns: 27499,2069653,3,"c2k.wfm","gsm.wfm","wcdma.wfm"</p>
Initial S/W Revision	A.09.00

ARB Setup

Allows access to the ARB setup sub-menus.

Key Path	Source, Modulation Setup, ARB
Initial S/W Revision	A.05.00

Sample Rate

Allows you to set the ARB waveform playback sample rate.

Key Path	Source, Modulation Setup, ARB, ARB Setup
Remote Command	:SOURce:RADio:ARB:SCLock:RATE <freq> :SOURce:RADio:ARB:SCLock:RATE?
Example	:SOUR:RAD:ARB:SCL:RATE 48.00 MHz
Notes	If there is a sample rate specified in the header of the waveform file, changing that sample rate is not recommended, as it may cause problems with burst timing.
Dependencies	When a new waveform is selected for playback the settings contained within the associated waveform header file are applied to the ARB. The sample rate is one of the values stored within the header file. If the newly selected waveform file has an associated header file, the sample rate is updated with the value from the header file. The sample rate will remain unchanged if the newly selected waveform does not have an associated header file.
Preset	125.00 MHz
Min	1.00 kHz
Max	125.00 MHz
Initial S/W Revision	A.05.00

Run-Time Scaling

Allows you to adjust the run-time scaling value. The run-time scaling value is applied in real-time while the waveform is playing.

Key Path	Source, Modulation Setup, ARB, ARB Setup
----------	---

Remote Command	:SOURce:RADio:ARB:RSCaling <real> :SOURce:RADio:ARB:RSCaling?
Example	:SOUR:RAD:ARB:RSC 100.00
Dependencies	When a new waveform is selected for playback the settings contained within the associated waveform header file are applied to the ARB. The run-time scaling is one of the values stored within the header file. If the newly selected waveform file has an associated header file, the run-time scaling is updated with the value from the header file. The run-time scaling will remain unchanged if the newly selected waveform does not have an associated header file.
Preset	70.00 %
Min	1.00 %
Max	100.00 %
Initial S/W Revision	A.05.00

Baseband Freq Offset

Allows you to adjust the value by which the baseband frequency is offset relative to the carrier.

Key Path	Source, Modulation Setup, ARB, ARB Setup
Remote Command	:SOURce:RADio:ARB:BASEband:FREQuency:OFFSet <freq> :SOURce:RADio:ARB:BASEband:FREQuency:OFFSet?
Example	:SOUR:RAD:ARB:BAS:FREQ:OFFS 0.00 Hz
Dependencies	When a new waveform is selected for playback the settings contained within the associated waveform header file are applied to the ARB. The baseband frequency offset is one of the values stored within the header file. If the newly selected waveform file has an associated header file, the baseband frequency offset is updated with the value from the header file. The baseband frequency offset will remain unchanged if the newly selected waveform does not have an associated header file.
Preset	0.00 Hz
Min	-50.00 MHz
Max	50.00 MHz
Initial S/W Revision	A.05.00

Edit RMS

Allows you to edit or calculate current RMS of selected waveform.

Key Path	Source, Modulation Setup, ARB, ARB Setup
Initial S/W Revision	A.14.50

Current RMS

Allows you to directly specify current RMS value used to playback currently selected waveform. Please note incorrect RMS value may cause inaccurate power output in E6640A that is sensitive to RMS value.

This setting is also updated by RMS in waveform header or updated when invoking RMS calculation operation.

This setting can be saved to the header of currently selected waveform by invoking ["Save Setup To Header" on page 707](#) "Save Setup To Header".

Key Path	Source, Modulation Setup, ARB, ARB Setup, Edit RMS
Remote Command	:SOURce:RADio:ARB:RMS <float> :SOURce:RADio:ARB:RMS?
Example	:SOUR:RAD:ARB:HEAD:RMS 0.7 :SOUR:RAD:ARB:HEAD:RMS?
Notes	Valid range is 0 to 1.414, values outside the range will be clipped to the closest boundary. Note this value does not affect "List Sequencer" on page 712 Source List Sequencer that always uses RMS value resides in each ARB header. If want this value to take effect in list sequencer, use "Save Setup To Header" on page 707 "Save Setup to Header" to save current RMS value to header first, then play the ARB in source list sequencer.
Dependencies	When a new waveform is selected for playback, this setting is updated by the RMS value defined in associated waveform header file. If selected waveform has no associated header file or header file does not specify RMS value, then instrument will try to calculate out one automatically. Calculating RMS can also update this setting.
Preset	0
Range	0 ~ 1.414
Initial S/W Revision	A.14.50

RMS Calculation Mode

Allows you to specify the mode to calculate the current RMS.

Key Path	Source, Modulation Setup, ARB, ARB Setup, Edit RMS
Remote Command	:SOURce:RADio:ARB:RMS:CALCulation:MODE AUTO M1 M2 M3 M4 :SOURce:RADio:ARB:RMS:CALCulation:MODE?
Example	:SOUR:RAD:ARB:RMS:CALC:MODE AUTO
Notes	If no waveform is selected, or selected waveform is waveform sequence, the key will grey out.
Preset	AUTO
Range	AUTO M1 M2 M3 M4
Initial S/W Revision	A.14.50

Auto

RMS will be calculated based on the whole sample range of current selected waveform.

Key Path	Source, Modulation Setup, ARB, ARB Setup, Edit RMS, Calculate RMS, RMS Calculation Mode
Example	:SOUR:RAD:ARB:RMS:CALC:MODE AUTO
Initial S/W Revision	A.14.50

Marker 1

Selects marker 1 to designate sample range used for RMS calculation.

Key Path	Source, Modulation Setup, ARB, ARB Setup, Edit RMS, Calculate RMS, RMS Calculation Mode , Marker
Example	:SOUR:RAD:ARB:RMS:CALC:MODE M1
Initial S/W Revision	A.14.50

Marker 2

Selects marker 2 to designate sample range used for RMS calculation.

Key Path	Source, Modulation Setup, ARB, ARB Setup, Edit RMS, Calculate RMS, RMS Calculation Mode , Marker
Example	:SOUR:RAD:ARB:RMS:CALC:MODE M2
Initial S/W Revision	A.14.50

Marker 3

Selects marker 3 to designate sample range used for RMS calculation.

Key Path	Source, Modulation Setup, ARB, ARB Setup, Edit RMS, Calculate RMS, RMS Calculation Mode , Marker
Example	:SOUR:RAD:ARB:RMS:CALC:MODE M3
Initial S/W Revision	A.14.50

Marker 4

Selects marker 4 to designate sample range used for RMS calculation.

Key Path	Source, Modulation Setup, ARB, ARB Setup, Edit RMS, Calculate RMS, RMS Calculation Mode , Marker
Example	:SOUR:RAD:ARB:RMS:CALC:MODE M4
Initial S/W Revision	A.14.50

Calculate RMS

Allows you to calculate current RMS based on mode selected. This will update ["Current RMS" on page 670](#) Current RMS setting.

Key Path	Source, Modulation Setup, ARB, ARB Setup, Edit RMS, Calculate RMS
Remote Command	:SOURce:RADio:ARB:RMS:CALCulate
Example	:SOUR:RAD:ARB:RMS:CALC
Notes	<p>If no waveform is selected, invoking this operation will get error “-221 Setting conflict; No waveform is selected for RMS operation”.</p> <p>If no waveform is selected, or selected waveform is waveform sequence, the key will grey out.</p> <p>If selected waveform does not contain marker data, but "RMS Calculation Mode" on page 670 “RMS Calculation Mode” is set to marker, under this circumstance, invoking calculation operation will get error “-221 Setting conflict; There is no marker for currently selected waveform, auto RMS calculation mode is used instead”, and "RMS Calculation Mode" on page 670 “RMS Calculation Mode” will be coupled to “Auto” mode automatically.</p> <p>RMS calculation does not suit for waveform sequence. If selected waveform is waveform sequence file, invoking this operation will get error “-221 Setting conflict; RMS calculation does not apply to waveform sequence”. But users can still edit current RMS as play parameter, and can save current RMS to waveform sequence header for later use.</p>
Initial S/W Revision	A.14.50

Use Header RMS

Allows you to quickly set RMS in ARB header to ["Current RMS" on page 670](#) Current RMS setting.

Key Path	Source, Modulation Setup, ARB, ARB Setup, Edit RMS,
Notes	<p>No remote command, front panel only.</p> <p>If no waveform is selected, the key will grey out.</p> <p>If no waveform is selected, invoking this operation will get error “-221 Setting conflict; No waveform is selected for RMS operation”.</p>
Initial S/W Revision	A.14.50

Real-Time AWGN Setup

The source allows you to apply additive white Gaussian noise (AWGN) to a carrier in real time while the modulating waveform plays in the dual ARB player. Pressing this key allows access to the real time AWGN sub-menus and changes the central display area to show the AWGN Setup view.

This feature is controlled by E6650A-AW1 option

Key Path	Source, Modulation Setup, ARB, ARB Setup
Notes	This menu only appears and related SCPIs are only available when E6650A-AW1 option presents.
Initial S/W Revision	A.16.00

Real-Time AWGN

Allows you to enable or disable adding real-time AWGN to the carrier modulated by the waveform currently being played by the dual ARB.

Key Path	Source, Modulation Setup, ARB, ARB Setup, Real-Time AWGN Setup
Remote Command	:SOURce:RADio:ARB:NOISe[:STATe] ON OFF 1 0 :SOURce:RADio:ARB:NOISe[:STATe]?
Example	:SOUR:RAD:ARB:NOIS OFF
Dependencies	When a new waveform is selected for playback the settings contained within the associated waveform header file are applied to the ARB. The AWGN state is one of the values stored within the header file. If the newly selected waveform file has an associated header file, the AWGN state is updated with the value from the header file. The AWGN state will remain unchanged if the newly selected waveform does not have an associated header file.
Couplings	If this setting is On and "ARB" on page 662 ARB State is On, "RF Power" on page 627 RF Power will be adjusted to the value to maintain the AWGN power relationship defined by "Power Control Mode" on page 674 Power Control Mode and other noise settings
Preset	Off
Range	On Off
Initial S/W Revision	A.16.00

Carrier To Noise Ratio

Allows you to specify the carrier to noise ratio (C/N) in dB. The carrier power is defined as the total modulated signal power without noise power added. The noise power is applied over the specified bandwidth of the carrier signal.

Key Path	Source, Modulation Setup, ARB, ARB Setup, Real-Time AWGN Setup
Remote Command	:SOURce:RADio:ARB:NOISe:CN <ampl> :SOURce:RADio:ARB:NOISe:CN?
Example	:SOUR:RAD:ARB:NOIS:CN 0.00 dB
Dependencies	When a new waveform is selected for playback the settings contained within the associated waveform header file are applied to the ARB. The AWGN C/N ratio is one of the values stored within the header file. If the newly selected waveform file has an associated header file, the AWGN C/N ratio is updated with the value from the header file. The AWGN C/N ratio will remain unchanged if the newly selected waveform does not have an associated header file.
Preset	0.00 dB
Min	-100.00 dB
Max	100.00 dB
Initial S/W Revision	A.16.00

Carrier Bandwidth

Allows you to specify the bandwidth over which the AWGN is applied. The carrier RMS power and the noise power are integrated over the selected carrier bandwidth for the purpose of calculating carrier to noise ratio (C/N).

Key Path	Source, Modulation Setup, ARB, ARB Setup, Real-Time AWGN Setup
Remote Command	:SOURce:RADio:ARB:NOISe:CBWidth <freq> :SOURce:RADio:ARB:NOISe:CBWidth?
Example	:SOUR:RAD:ARB:NOIS:CBW 1.00 Hz
Dependencies	When a new waveform is selected for playback the settings contained within the associated waveform header file are applied to the ARB. The AWGN carrier bandwidth is one of the values stored within the header file. If the newly selected waveform file has an associated header file, the AWGN carrier bandwidth is updated with the value from the header file. The AWGN carrier bandwidth will remain unchanged if the newly selected waveform does not have an associated header file.
Min	1.00 Hz
Max	200.00 MHz
Initial S/W Revision	A.16.00

Noise Bandwidth

Allows you to specify the flat noise bandwidth of the real-time noise for an ARB waveform.

Key Path	Source, Modulation Setup, ARB, ARB Setup, Real-Time AWGN Setup
Remote Command	:SOURce:RADio:ARB:NOISe:BANDwidth <freq> :SOURce:RADio:ARB:NOISe:BANDwidth?
Example	:SOUR:RAD:ARB:NOIS:BAND 1.00 Hz
Notes	Generally, flat noise bandwidth should be set slightly wider than the carrier bandwidth (typically 1.6 times wider)
Notes	Max Noise Bandwidth equals $0.8 * \text{Maximum ARB Sample Rate}$ reported in HW capability
Dependencies	When a new waveform is selected for playback the settings contained within the associated waveform header file are applied to the ARB. The AWGN carrier bandwidth is one of the values stored within the header file. If the newly selected waveform file has an associated header file, the AWGN carrier bandwidth is updated with the value from the header file. The AWGN carrier bandwidth will remain unchanged if the newly selected waveform does not have an associated header file.
Preset	1.00 Hz
Min	1.00 Hz
Max	160.00 MHz
Initial S/W Revision	A.16.00

Power Control Mode

This setting offers four ways to control the RF output power when adding AWGN to a signal.

Key Path	Source, Modulation Setup, ARB, ARB Setup, Real-Time AWGN Setup
Remote Command	:SOURce:RADio:ARB:NOISe:POWer:CONTRol[:MODE] TOTal CARRier NOISe NCHannel :SOURce:RADio:ARB:NOISe: POWer:CONTRol[:MODE]?
Example	:SOUR:RAD:ARB:NOIS:POW:CONT NCHannel :SOUR:RAD:ARB:NOIS:POW:CONT?
Preset	TOTal
Range	Total Power Carrier Power Total Noise Power Noise Power in Channel
Initial S/W Revision	A.16.00

Total

Set the power control mode as total power.

Key Path	Source, Modulation Setup, ARB, ARB Setup, Real-Time AWGN Setup, Power Control Mode
Example	:SOUR:RAD:ARB:NOIS:POW:CONT TOTAl
Couplings	Set to this value will make Carrier Power Carrier Power, Total Noise Power Total Noise Power, and Channel Noise Power Channel Noise Power buttons invisible on menu. Selecting Total as the power control mode makes the total power and C/N independent variables while making the carrier power and total noise power dependent variables. The dependent variables carrier power and total noise power are set by the total power, C/N, and the rest of the Noise settings. The carrier power and total noise power change as any noise parameter is adjusted to keep the total power and the C/N at their last specified values.
Initial S/W Revision	A.16.00

Carrier

Set the power control mode as carrier power.

Key Path	Source, Modulation Setup, ARB, ARB Setup, Real-Time AWGN Setup, Power Control Mode
Example	:SOUR:RAD:ARB:NOIS:POW:CONT CARRier
Couplings	Set to this value will make Carrier Power Carrier Power button visible, while Total Noise Power Total Noise Power and Channel Noise Power Channel Noise Power buttons invisible from menu. Selecting Carrier as the power control mode makes the carrier power and C/N independent variables while making the total power and total noise power dependent variables. The dependent variables total power and total noise power are set by the carrier power, C/N, and the rest of the Noise settings. The total power and total noise power change as any noise parameter is adjusted to keep the carrier power and the C/N at their last specified values.
Initial S/W Revision	A.16.00

Total Noise

Set the power control mode as total noise power.

Key Path	Source, Modulation Setup, ARB, ARB Setup, Real-Time AWGN Setup, Power Control Mode
Example	:SOUR:RAD:ARB:NOIS:POW:CONT NOISe
Couplings	Set to this value will make Total Noise Power Total Noise Power button visible, while Carrier Power Carrier Power and Channel Noise Power Channel Noise Power buttons invisible from menu. Selecting Total Noise as the power control mode makes the total noise power and C/N independent variables while making the total power and carrier power dependent variables. The dependent variables total power and carrier power are set by the total noise power, C/N, and the rest of the Noise settings. The total power and carrier power change as any noise parameter is adjusted to keep the total noise power and the C/N at their last specified values.
Initial S/W Revision	A.16.00

Channel Noise

Set the power control mode as channel noise power.

Key Path	Source, Modulation Setup, ARB, ARB Setup, Real-Time AWGN Setup, Power Control Mode
Example	:SOUR:RAD:ARB:NOIS:POW:CONT NCHannel
Couplings	Set to this value will make Channel Noise Power Channel Noise Power button visible, while Total Noise Power Total Noise Power and Carrier Power Carrier Power buttons invisible from menu. Selecting Channel Noise as the power control mode makes the noise power in channel and C/N independent variables while making the carrier power and total noise power dependent variables. The dependent variables carrier power and total noise power are set by the channel noise power, C/N, and the rest of the Noise settings. The carrier power and total noise power change as any noise parameter is adjusted to keep the channel noise power and the C/N at their last specified values.
Initial S/W Revision	A.16.00

Trigger Type

Allows access to the trigger type sub-menus. The setting for trigger type determines the behavior of the waveform when it plays.

Key Path	Source, Modulation Setup, ARB
Remote Command	:SOURce:RADio:ARB:TRIGger:TYPE CONTInuous SINGLE SADVance :SOURce:RADio:ARB:TRIGger:TYPE?
Example	:SOUR:RAD:ARB:TRIG:TYPE CONT :SOUR:RAD:ARB:TRIG:TYPE?
Notes	Gated trigger type will be implemented at a later release
Preset	CONTInuous
Range	Continuous Single Seg Adv
Initial S/W Revision	A.05.00

Continuous

Sets the active trigger type to Continuous. If Continuous is already selected as the active trigger type, pressing this key allows access to the continuous trigger type setup menu. In Continuous trigger mode, the waveform repeats continuously.

Key Path	Source, Modulation Setup, ARB, Trigger Type
Remote Command	:SOURce:RADio:ARB:TRIGger:TYPE:CONTinuous[:TYPE] FREE TRIGger RESet :SOURce:RADio:ARB:TRIGger:TYPE:CONTinuous[:TYPE]?
Example	:SOUR:RAD:ARB:TRIG:TYPE:CONT FREE
Preset	FREE
Range	Free Run Trigger + Run Reset + Run
Initial S/W Revision	A.05.00

Free Run

Selects Free Run as the trigger response for the continuous trigger type. Free Run sets the waveform generator to play a waveform sequence or segment continuously, without waiting for a trigger. In this mode, the waveform generator does not respond to triggers.

Key Path	Source, Modulation Setup, ARB, Trigger Type, Continuous
Example	:SOUR:RAD:ARB:TRIG:TYPE:CONT FREE
Initial S/W Revision	A.05.00

Trigger + Run

Sets Trigger and Run as the trigger response for the continuous trigger type. Trigger and Run sets the waveform generator to play a waveform sequence or segment continuously when the first trigger is received, and to ignore any subsequent triggers.

Key Path	Source, Modulation Setup, ARB, Trigger Type, Continuous
Example	:SOUR:RAD:ARB:TRIG:TYPE:CONT TRIG
Initial S/W Revision	A.05.00

Reset + Run

Sets Reset and Run as the trigger response for the continuous trigger type. Reset and Run sets the waveform generator to play a waveform sequence or segment continuously when the first trigger is received. Subsequent triggers reset the waveform sequence or segment to the start, and then play it continuously.

Key Path	Source, Modulation Setup, ARB, Trigger Type, Continuous
Example	:SOUR:RAD:ARB:TRIG:TYPE:CONT RES
Initial S/W Revision	A.05.00

Single

Sets the active trigger type to Single. If Single is already selected as the active trigger type, pressing this key allows access to the single trigger type setup menu. In Single trigger mode, the waveform plays once.

Key Path	Source, Modulation Setup, ARB, Trigger Type
Remote Command	:SOURce:RADio:ARB:RETRigger ON OFF IMMediate :SOURce:RADio:ARB:RETRigger?
Example	:SOUR:RAD:ARB:RETR OFF
Notes	ON: Buffered Trigger OFF: No Retrigger Immediate: Restart on Trigger This is defined as an enumerated SCPI command, with ON OFF being considered as enumerated types rather than Boolean. This means the query will return OFF instead of 0, and ON instead of 1.
Preset	ON
Range	No Retrigger Buffered Trigger Restart on Trigger
Initial S/W Revision	A.05.00

No Retrigger

Selects No Retrigger as the trigger response for single trigger type. No Retrigger sets the waveform generator to play a waveform sequence or segment once when a trigger is received. Any triggers then received during playback are ignored.

Key Path	Source, Modulation Setup, ARB, Trigger Type, Single
Example	:SOUR:RAD:ARB:RETR OFF
Initial S/W Revision	A.05.00

Buffered Trigger

Selects Buffered Trigger as the trigger response for single trigger type. Buffered Trigger sets the waveform generator to play a waveform sequence or segment once when a trigger is received. If a trigger is received during playback, the waveform generator plays the sequence or segment to the end, then plays the sequence or segment once more.

Key Path	Source, Modulation Setup, ARB, Trigger Type, Single
Example	:SOUR:RAD:ARB:RETR ON
Initial S/W Revision	A.05.00

Restart on Trigger

Selects Restart on Trigger as the trigger response for single trigger type. Restart on Trigger sets the waveform generator to play a waveform sequence or segment once when a trigger is received. If a trigger is received during playback, the waveform generator resets and plays the sequence or segment from the start.

Key Path	Source, Modulation Setup, ARB, Trigger Type, Single
Example	:SOUR:RAD:ARB:RETR IMM
Initial S/W Revision	A.05.00

Segment Advance

Sets the active trigger type to Segment Advance. If Segment Advance is already selected as the active trigger type, pressing this key allows access to the segment advance trigger type setup menu.

Segment Advance triggering allows you to control the playback of waveform segments within a waveform sequence. When a trigger is received the ARB advances to the next waveform segment within the waveform sequence. This type of triggering ignores the repetition count for the waveform segment within the waveform sequence. For example, if a waveform segment has a repetition count of 10 and you select single segment advance triggering mode, the waveform segment will only play once.

Segment Advance triggering can also be used for waveform segments only. In this situation the same waveform segment is played again when a trigger is received.

Key Path	Source, Modulation Setup, ARB, Trigger Type
Remote Command	:SOURce:RADio:ARB:TRIGger:TYPE:SADVance[:TYPE] SINGLE CONTInuous :SOURce:RADio:ARB:TRIGger:TYPE:SADVance[:TYPE] ?
Example	:SOUR:RAD:ARB:TRIG:TYPE:SADV SING
Preset	CONTInuous
Range	Single Continuous
Initial S/W Revision	A.05.00

Single

Selects Single as the trigger response for Segment Advance trigger type. With single selected, once a trigger is received a segment is played once. If a trigger is received during playback of a segment, the segment plays to completion and the next segment is played once.

Key Path	Source, Modulation Setup, ARB, Trigger Type, Segment Advance
Example	:SOUR:RAD:ARB:TRIG:TYPE:SADV SING
Initial S/W Revision	A.05.00

Continuous

Selects Continuous as the trigger response for Segment Advance trigger type. With continuous selected, once a trigger is received a segment is played continuously. When subsequent triggers are received, the currently playing segment plays to completion and then the next segment is played continuously.

Key Path	Source, Modulation Setup, ARB, Trigger Type, Segment Advance
Example	:SOUR:RAD:ARB:TRIG:TYPE:SADV CONT
Initial S/W Revision	A.05.00

Trigger Source

The trigger source setting determines how the source receives the trigger that starts the waveform playing. Therefore, this key is grayed out if the trigger type is free run, since free run triggers immediately with no trigger source required.

Key Path	Source, Modulation Setup, ARB
Remote Command	:SOURce:RADio:ARB:TRIGger[:SOURce] KEY BUS EXTernal2 :SOURce:RADio:ARB:TRIGger[:SOURce]?
Example	:SOUR:RAD:ARB:TRIGger KEY
Dependencies	This key is grayed out if the current trigger type is Continuous, Free Run.
Preset	EXTernal2
Range	Trigger Key Bus External 2
Initial S/W Revision	A.05.00

Trigger Key

Sets the current trigger source to the front panel Trigger key. When Trigger Key is selected, the waveform is triggered when you press the front panel Trigger key.

Key Path	Source, Modulation Setup, ARB, Trigger Source
Example	:SOUR:RAD:ARB:TRIGger KEY
Initial S/W Revision	A.05.00

Bus

Sets the current trigger source to Bus. Selecting Bus trigger source enables triggering over GPIB, LAN, or USB using the :SOURce:RADio:ARB:TRIGger:INITiate command.

Key Path	Source, Modulation Setup, ARB, Trigger Source
Example	:SOUR:RAD:ARB:TRIGger BUS
Initial S/W Revision	A.05.00

External 2

Sets the current trigger source to External 2. Selecting External 2 enables triggering a waveform by an externally applied signal.

Key Path	Source, Modulation Setup, ARB, Trigger Source
Example	:SOUR:RAD:ARB:TRIGger EXT2
Notes	Note: When on E6640A, trigger 2 is a bi-directional trigger port. So when trigger 2 has been configured as OUTPUT type, choosing External 2 as the input trigger for the current step will generate error.
Initial S/W Revision	A.05.00

Trigger Initiate

Used to initiate an immediate trigger event if the trigger source is set to Trigger Key.

Key Path	Source, Modulation Setup, ARB
Notes	No remote command, SCPI front panel only.
Initial S/W Revision	A.05.00

Waveform Sequences

Allows access to the waveform sequence sub-menus. Pressing this key changes the central view area to display the Waveform Sequence List view.

Key Path	Source, Modulation Setup, ARB
Notes	No remote command, SCPI front panel only.
Initial S/W Revision	A.05.00

Build New Sequence

Allows access to the sub-menus for creating a new waveform sequence. Pressing this key changes the central view area to display the Waveform Sequence Creation and Editing view.

Key Path	Source, Modulation Setup, ARB, Waveform Sequences
Notes	No remote command, SCPI front panel only.
Initial S/W Revision	A.05.00

Current Segment

Specifies the selected sequence segment that will be affected by the menu functions.

Key Path	Source, Modulation Setup , ARB, Waveform Sequences, Build New Sequence
Notes	No remote command, SCPI front panel only. This key is grayed out and unavailable if the sequence is currently empty.
Initial S/W Revision	A.05.00

Insert New Waveform

Allows you access to the sub-menu for inserting a new waveform segment or sequence. Pressing this key also changes the central display to show the Waveform File Selection View.

Key Path	Source, Modulation Setup, ARB, Waveform Sequences, Build New Sequence
Notes	No remote command, SCPI front panel only. Waveform segment name string length upper limit is 128 chars. Please do NOT insert waveform which name string exceeds 128 chars.
Initial S/W Revision	A.05.00

Insert Waveform

Inserts the currently highlighted waveform to the end of the waveform sequence. Pressing this key also returns you to the menus for creating or editing a sequence, and returns the central view to the sequence creation view.

Key Path	Source, Modulation Setup, ARB, Waveform Sequences, Build New Sequence, Insert New Waveform
Notes	No remote command, SCPI front panel only. Waveform segment name string length upper limit is 128 chars. Please do NOT insert waveform which name string exceeds 128 chars.
Initial S/W Revision	A.05.00

Segments on Hard Disk

Allows you access to the sub-menus for loading waveform segments from the hard disk into ARB memory. The default directory is: D: varb.

Pressing this key changes the current view to the Waveform Management View.

Key Path	Source, Modulation Setup, ARB, Select Waveform
Initial S/W Revision	A.05.00

Load Segment To ARB Memory

Allows you to load the selected file into ARB memory. On the front panel you select the file for loading to the ARB memory by highlighting the desired file in the list. Using the SCPI command, you specify the file name on the HDD.

“NVWFM” (none-volatile storage) MSUS (Mass Storage Unit Specifier) is supported in the memory subsystem because the ARB memory cannot be accessed directly. Therefore, files must be downloaded to the instrument hard disk and then loaded into the ARB memory. “NVWFM” MSUS will be mapped to the default directory D: VARB. The SCPI command supports using either “NVWFM” MSUS or specifying a full path. For more information, see [Memory Subsystem \(Remote Command Only\)](#).

If a file of the same name already exists within ARB memory, it is overwritten. If you wish to load two segments of the same name, you must rename one of the segments before loading it into ARB memory. To rename a segment, you can either use Windows File Explorer, or the :MMEMory:COPI command.

Key Path	Source, Modulation Setup, ARB, Select Waveform, Segments on Hard Disk
Remote Command	:SOURce:RADio:ARB:LOAD <string>
Example	:SOUR:RAD:ARB:LOAD "D: VARB\testwaveform.bin" or :SOUR:RAD:ARB:LOAD "NVWFM:testwaveform.bin"
Notes	<p>Because loading the file involves a delay of unpredictable length, this command should be followed by the query *OPC?, which holds off subsequent commands until the loading operating is complete.</p> <p><string> – specifies the path name of the file to load from the HDD into ARB memory. It could be a <full path + filename>, or <“NVWFM” MSUS + colon + filename>.</p> <p>When in Sequence Analyzer mode, and Include Source is Yes, an attempt to load a file to ARB memory will be rejected with an error.</p> <p>When Include Source is No and if there is insufficient free ARB memory to load the selected waveform, an error is generated. .</p> <p>If you specify a file over SCPI, but the file is not at the specified location, an error is generated.</p> <p>If you try to load a waveform file but the file contains less than 500 IQ samples, an error is generated.</p> <p>If you try to load a Signal Studio waveform “*.wfm” which contains invalid waveform header, an error is generated.</p> <p>If the ARB is ON when you load a file to ARB memory or delete a file from ARB memory, the playing waveform segment may not keep phase continuity during the ARB memory operation. The waveform will be replayed after the ARB operation is finished.</p> <p>ARB can be loaded into ARB memory even required licenses do not present on the instrument. In this case, a GUI only warning message -800, “Operation complete; Loaded <filename> successfully, but no license <required licenses> installed”. User can install required licenses according to <required licenses> string to license it, or multi-pack license it.</p>
Initial S/W Revision	A.05.00

Load All To ARB Memory

Allows you to load all the segment files within the currently selected directory into ARB memory. If a file of the same name already exists within ARB memory, it is overwritten. If you wish to load two segments of the

same name, you must rename one of the segments before loading it into ARB memory. To rename a segment, you can either use Windows File Explorer, or the :MEMory:COpy command.

Key Path	Source, Modulation Setup, ARB, Select Waveform, Segments on Hard Disk
Remote Command	:SOURce:RADio:ARB:LOAD:ALL <string>
Example	:SOUR:RAD:ARB:LOAD:ALL "D: varb"
Notes	<p><string> - specifies the directory on the HDD to load the files into ARB memory from.</p> <p>When in Sequence Analyzer mode, and Include Source is Yes, an attempt to load all files from a directory to ARB memory is rejected with an error.</p> <p>When Include Source is No and there is insufficient free ARB memory to load all the waveforms, when the ARB memory is full, the copy ceases, and an error is generated.</p> <p>If you specify a directory over SCPI, but the directory does not exist, an error is generated.</p> <p>If the ARB is ON, a user then loads or deletes file to ARB memory, the playing waveform segment may not keep phase continuity during the ARB memory operation. The waveform will be replayed after the ARB operation is finished.</p>
Initial S/W Revision	A.05.00

Change Directory...

Allows you to change the currently selected directory on the hard disk. Pressing this key opens a standard windows change directory dialog allowing you to select the new directory of interest.

The current directory is used for manually loading waveform segments into ARB memory for playback, and as a search location for waveform segments that are required to be loaded into ARB memory for playback of a waveform sequence or a list sequence.

Key Path	Source, Modulation Setup, ARB, Select Waveform, Segments on Hard Disk
Notes	No remote command, SCPIfront panel only.
Initial S/W Revision	A.05.00

Default Directory...

Allows you to change the default directory. It is used as a search location for waveform segments that are required to be loaded into ARB memory for playback of a waveform sequence, and as a search location for selecting waveforms using SCPI.

Key Path	Source, Modulation Setup, ARB, Select Waveform, Segments on Hard Disk
Remote Command	:SOURce:RADio:ARB:DEFault:DIRectory <string> :SOURce:RADio:ARB: DEFault:DIRectory?
Example	:SOUR:RAD:ARB:DEF:DIR "D:\ArbFiles" :SOUR:RAD:ARB:DEF:DIR?
State Saved	Persistent, survives a power cycle and a preset but not saved in the instrument state
Initial S/W Revision	A.05.00

Segments in ARB Memory

Allows you access to the sub-menus for managing the files within ARB memory.

Key Path	Source, Modulation Setup, ARB, Select Waveform
Initial S/W Revision	A.05.00

Delete Segment From ARB Mem

Allows you to remove a segment from ARB playback memory.

Key Path	Source, Modulation Setup, ARB, Select Waveform, Segments in ARB Memory
Remote Command	:SOURce:RADio:ARB:DELeTe <string>
Example	:SOUR:RAD:ARB:DEL "testwaveform.bin"
Notes	<p><string> - specifies the waveform to be deleted from the ARB playback memory.</p> <p>When in Sequence Analyzer mode and Include Source is Yes, an attempt to delete a file from ARB memory is rejected with an error.</p> <p>When Include Source is No and you specify a file that does not exist within ARB memory, an error is generated.</p> <p>It is possible to delete files from within the ARB memory when the ARB is ON. However, if you attempt to delete the file that is currently playing an error is generated.</p> <p>It is possible to delete a file from within the ARB memory when the sequencer state is ON and the file is not being used by the List Sequencer. If you attempt to delete a file which is being used by the list sequencer, an error is generated.</p> <p>When sequencer state is On, even if ARB state is On, the selected waveform will not be played. In this case, if the selected waveform is not used in List Sequence, it can be deleted and the ARB state is turned Off.</p> <p>If the ARB is ON and you load a file to ARB memory or delete a file from ARB memory, the playing waveform segment may not keep phase continuity during the ARB memory operation. The waveform will be replayed after the ARB operation is finished.</p>
Initial S/W Revision	A.05.00

Delete All From ARB Memory

Allows you to remove all segments from ARB playback memory.

Key Path	Source, Modulation Setup, ARB, Select Waveform, Segments in ARB Memory
Remote Command	:SOURce:RADio:ARB:DELeTe:ALL
Example	:SOUR:RAD:ARB:DELeTe:ALL
Notes	<p>When in Sequence Analyzer mode and Include Source is Yes, an attempt to delete all files from ARB memory is rejected with an error.</p> <p>When Include Source is No and you attempt to delete all files from ARB memory when the ARB is currently playing a file, all files except the one playing are deleted and an error is generated.</p> <p>If you attempt to delete all files from ARB memory when there are waveform files used in "List</p>

Sequencer" on page 712 and **"Sequencer" on page 713** state is ON, all files except the files currently being used in list sequencer are deleted, and an error is generated.

If the ARB is ON and you load a file to ARB memory or delete a file from ARB memory, the playing waveform segment may not keep phase continuity during the ARB memory operation. The waveform will be replayed after the ARB operation is finished.

Initial S/W Revision	A.05.00
----------------------	---------

Segments on Hard Disk

This key functions the same as **"Segments on Hard Disk" on page 738**.

Key Path	Source, Modulation Setup, ARB, Waveform Sequences, Build New Sequence, Insert New Waveform
----------	---

Initial S/W Revision	Prior to A.09.00
----------------------	------------------

Load Segment To ARB Memory

This key functions the same as **"Load Segment To ARB Memory" on page 738**.

Key Path	Source, Modulation Setup, ARB, Waveform Sequences, Build New Sequence, Insert New Waveform, Segment on Hard Drive
----------	--

Initial S/W Revision	Prior to A.09.00
----------------------	------------------

Load All To ARB Memory

This key functions the same as **"Load All To ARB Memory" on page 739**.

Key Path	Source, Modulation Setup, ARB, Waveform Sequences, Build New Sequence, Insert New Waveform, Segment on Hard Drive
----------	--

Initial S/W Revision	Prior to A.09.00
----------------------	------------------

Change Directory ...

This key functions the same as **"Change Directory..." on page 740**.

Key Path	Source, Modulation Setup, ARB, Waveform Sequences, Build New Sequence, Insert New Waveform, Segment on Hard Drive
----------	--

Initial S/W Revision	Prior to A.09.00
----------------------	------------------

Default Directory ...

This key functions the same as **"Default Directory..." on page 740**

Key Path	Source, Modulation Setup, ARB, Waveform Sequences, Build New Sequence, Insert New Waveform, Segment on Hard Drive
Initial S/W Revision	Prior to A.09.00

Segments in ARB Memory

This key functions the same as ["Segments in ARB Memory" on page 740](#).

Key Path	Source, Modulation Setup, ARB, Waveform Sequences, Build New Sequence, Insert New Waveform
Initial S/W Revision	Prior to A.09.00

Delete Segment From ARB Memory

This key functions the same as ["Delete Segment From ARB Mem" on page 741](#).

Key Path	Source, Modulation Setup, ARB, Waveform Sequences, Build New Sequence, Insert New Waveform, Segment in ARB Memory
Initial S/W Revision	Prior to A.09.00

Delete All From ARB Memory

This key functions the same as ["Delete All From ARB Memory" on page 741](#).

Key Path	Source, Modulation Setup, ARB, Waveform Sequences, Build New Sequence, Insert New Waveform, Segment in ARB Memory
Initial S/W Revision	Prior to A.09.00

Query ARB Memory File List (Remote Command Only)

This command functions the same as ["Query ARB Memory File List \(Remote Command Only\)" on page 667](#).

Initial S/W Revision	Prior to A.09.00
----------------------	------------------

Edit Selected Waveform

Allows access to the sub-menus for editing the details of the currently selected waveform segment.

Key Path	Source, Modulation Setup, ARB, Waveform Sequences, Build New Sequence
Notes	No remote command, front panel only.
Initial S/W Revision	A.05.00

Repetitions

Allows you to specify the number of times the currently selected waveform is played within the sequence.

Key Path	Source, Modulation Setup, ARB, Waveform Sequences, Build New Sequence, Edit Selected Waveform
Notes	No remote command, SCPI front panel only.
Preset	1
Min	1
Max	65535
Initial S/W Revision	A.05.00

Marker 1

Allows you to enable or disable marker 1 for the currently selected waveform. For a waveform sequence, you can enable and disable markers on a per-segment basis, allowing you to output markers from some waveform segments within the sequence, but not for others.

Key Path	Source, Modulation Setup, ARB, Waveform Sequences, Build New Sequence, Edit Selected Waveform
Notes	No remote command, front panel only.
Preset	Enabled
Range	Enabled Disabled
Initial S/W Revision	A.05.00

Marker 2

Allows you to enable or disable marker 2 for the currently selected waveform. For a waveform sequence, you can enable and disable markers on a per-segment basis, allowing you to output markers from some waveform segments within the sequence, but not for others.

Key Path	Source, Modulation Setup, ARB, Waveform Sequences, Build New Sequence, Edit Selected Waveform
Notes	No remote command, front panel only.
Preset	Enabled
Range	Enabled Disabled
Initial S/W Revision	A.05.00

Marker 3

Allows you to enable or disable marker 3 for the currently selected waveform. For a waveform sequence, you can enable and disable markers on a per-segment basis, allowing you to output markers from some waveform segments within the sequence, but not for others.

Key Path	Source, Modulation Setup, ARB, Waveform Sequences, Build New Sequence, Edit Selected Waveform
Notes	No remote command, front panel only.
Preset	Enabled
Range	Enabled Disabled
Initial S/W Revision	A.05.00

Marker 4

Allows you to enable or disable marker 4 for the currently selected waveform. For a waveform sequence, you can enable and disable markers on a per-segment basis, allowing you to output markers from some waveform segments within the sequence, but not for others.

Key Path	Source, Modulation Setup, ARB, Waveform Sequences, Build New Sequence, Edit Selected Waveform
Notes	No remote command, front panel only.
Preset	Enabled
Range	Enabled Disabled
Initial S/W Revision	A.05.00

Delete Segment

Allows you to delete the selected segment from the waveform sequence.

Key Path	Source, Modulation Setup, ARB, Waveform Sequences, Build New Sequence
Notes	No remote command, front panel only.
Initial S/W Revision	A.05.00

Save Sequence...

Pressing this key displays the “Save As” dialog. The sequence name is passed to the save as dialog to use as the filename for saving, and the directory the save as dialog will open into is the default waveform directory.

Key Path	Source, Modulation Setup, ARB, Waveform Sequences, Build New Sequence
Initial S/W Revision	A.05.00

Build New Sequence (Remote Command Only)

This command is the SCPI equivalent of the waveform sequence creation features described in ["Build New Sequence" on page 681](#).

This command writes a waveform sequence file to the hard disk. You must specify the waveform sequence file path and filename which will be saved on the hard disk, and the waveform segment file path and name which will be nested into the waveform sequence file. You can utilize mass storage unit specifier (MSUS) "NVWFM" or use a real full path representation. See the example below. MSUS "NVWFM" is mapped to D:VARB directory on test set hard disk.

Any number of segments, up to a segment count limit of 64, can be used to create a sequence. Repeated segments are included in the count limit.

Each waveform segment name string length upper limit is 128 chars. Please do NOT insert waveform which name string exceeds 128 chars.

The internal source does not support nesting one waveform sequence file into another waveform sequence file.

Remote Command :SOURce:RADio:ARB:SEQuence[:MWAveform] <filename>, <waveform1>, <reps>, NONE | M1 | M2 | M3 | M4 | M1M2 | M1M3 | M1M4 | M2M3 | M2M4 | M3M4 | M1M2M3 | M1M2M4 | M1M3M4 | M2M3M4 | M1M2M3M4 | ALL, {<waveform2>, <reps>, NONE | M1 | M2 | M3 | M4 | M1M2 | M1M3 | M1M4 | M2M3 | M2M4 | M3M4 | M1M2M3 | M1M2M4 | M1M3M4 | M2M3M4 | M1M2M3M4 | ALL, } ...

(For additional description of each item, see Notes below ["For Setup SCPI" on page 690](#) "For Setup SCPI".)

:SOURce:RADio:ARB:SEQuence[:MWAveform]? <filename>

(For additional description of each item, see Notes ["For Query SCPI" on page 691](#) below.)

Example For setup:

```
>:SOUR:RAD:ARB:SEQ "NVWFM:testSeq1.seq", "NVWFM:wfmSegment1.wfm", 10, M2M3M4, "NVWFM:wfmSegment2.wfm", 20, M1 M3
```

Or

```
>:SOUR:RAD:ARB:SEQ "D: VARB\testSeq1.seq", " D: VARB\wfmSegment1.wfm", 10, M2M3M4, " D: VARB\wfmSegment2.wfm", 20, M1 M3
```

For query, must specify which waveform sequence file to query.

```
>:SOUR:RAD:ARB:SEQ? "NVWFM:testSeq1.seq"
```

Or

```
>:SOUR:RAD:ARB:SEQ? "D: VARB\testSeq1.seq",
```

Notes For Setup SCPI

For the Setup SCPI command, the parameters are:

<filename> - String Type

This variable specifies the path and name for the waveform sequence file. The path supports MSUS (NVWFM) or a real full path representation. See example.

<waveform1> - String Type

This variable specifies the path and name of the first existing waveform segment. The path supports

MSUS (NVWFM) or a real full path representation. See example.

The segment file must reside within ARB playback memory before it can be played by the ARB player.

<reps> - Integer Type

This variable specifies the number of times a segment or sequence plays before moving on to the next segment or sequence.

<marker> - Enum Type

NONE – This choice disables all four markers for the waveform. Disabling markers means that the waveform sequence ignores the segments or sequence marker settings.

M1, M2, M3, M4 – these choices, either individually or a combination of them, enable the markers for the waveform segment or sequence. Markers not specified are ignored for that segment or sequence.

ALL – This choice enables all four markers in the waveform segment or sequence.

<waveform2> - String type.

This variable specifies the name of a second existing waveform segment. The path supports MSUS (NVWFM) and real full path representation both. See example.

The segment file must reside within ARB playback memory before it can be played by the ARB player.

<reps> same as above, for the 2nd waveform segment.

<marker> same as above, for the 2nd waveform segment.

You can insert several waveform segments into a waveform sequence file. Just repeat inserting waveform segments as described above.

Error Checks for Setup SCPI command:

If you do not specify a filename, or you use an unsupported MSUS (that is, not NVWFM), or have an error in the waveform sequence file path, an error is generated.

Notes

Error Checks for Query SCPI command: (Continued)

If the specified waveform sequence file name suffix is not “.seq”, error is generated.

If you use an unsupported MSUS (that is, not NVWFM), or have an error in the waveform segment file path, an error is generated.

If the first specified waveform file cannot be found, an error is generated.

If you nest one waveform sequence file into another waveform sequence file, an error is generated.

If the specified repetition value is larger than 65535 or smaller than 1, an error is generated.

If the specified marker type is unrecognized, an error is generated.

For Query SCPI

For the Query the parameters are:

<filename> - String type.

This variable specifies the path and name of the waveform sequence file being queried. The path supports MSUS (NVWFM) or a real full path representation. See example.

The return value is a <string>, which includes each waveform segment file name, repetitions, and marker type. For example:

```
>:SOUR:RAD:ARB:SEQ? "NVWFM:testSeq1.seq",
```

```
<"wfmSegment1. wfm, 10, ALL, wfmSegment2.wfm, 20, M1M3",
```

Error Checks for Query SCPI command:

If you do not specify a filename, an error is generated.
 If the waveform sequence file name is empty, an error is generated.
 If the specified waveform sequence file cannot be found, an error is generated.

Initial S/W Revision	A.05.00
----------------------	---------

Edit Selected Sequence

Allows access to the sub-menus for editing the sequence currently selected within the Waveform Sequence List view. Pressing this key changes the central view area to display the Waveform Sequence Creation and Editing view.

Key Path	Source, Modulation Setup, ARB, Waveform Sequences
----------	--

Notes	No remote command, front panel only.
-------	--------------------------------------

Initial S/W Revision	A.05.00
----------------------	---------

Current Directory...

Allows you to change the currently selected directory on the hard disk. Pressing this key opens a standard windows change directory dialog and allows you to select the new directory of interest.

Key Path	Source, Modulation Setup, ARB, Waveform Sequences
----------	--

Notes	No remote command, front panel only.
-------	--------------------------------------

Initial S/W Revision	A.05.00
----------------------	---------

Waveform Utilities

Allows you access to the waveform utilities sub-menus.

Key Path	Source, Modulation Setup, ARB
----------	--------------------------------------

Initial S/W Revision	A.05.00
----------------------	---------

Multi-Pack Licenses

Allows you access to the Multi - Pack License sub-menus. Pressing this key also changes the central view area to display the Multi -Pack License Management view.

On modular instrument like E6630A or E6640A, multi-pack license operations are only allowed on the default module, i.e. "Left" module for E6630A or "TRX1" module for E6640A.

Key Path	Source, Modulation Setup, ARB, Waveform Utilities
----------	--

Dependencies	This key is only available if there is at least one Multi-pack license installed on the instrument.
--------------	---

Initial S/W Revision	A.05.00
----------------------	---------

Add Waveform

Pressing this key accesses the Add Waveform sub-menu. It also changes the central display area to display the Multi-Pack License Waveform Add view.

Key Path	Source, Modulation Setup, ARB, Waveform Utilities, Multi-Pack Licenses
Dependencies	This key is only available if there is at least one slot available within at least one multi-pack license.
Initial S/W Revision	A.05.00

Add Waveform

Allows you to add the currently selected waveform segment to a multi-pack license. The new waveform is added to the next available slot regardless of which slot was selected on the Multi-Pack License Management view.

Key Path	Source, Modulation Setup, ARB, Waveform Utilities, Multi-Pack Licenses, Add Waveform
Remote Command	:SYSTem:LKEY:WAVeform:ADD <string> or :SYSTem:LIcense[:FPACK]:WAVeform:ADD <string>
Example	SYST:LKEY:WAV:ADD "mywaveform.wfm" or SYST:LIC:WAV:ADD "mywaveform.wfm"
Notes	The second SCPI :SYSTem:LIcense[:FPACK]:WAVeform:ADD is provided to be consistent with the style of Keysight signal sources. You can use either one of them. Since adding a waveform segment to a Multi-Pack license causes the license slot to enter the trial period of only 48 hours, pressing this key causes a confirmation dialog to be displayed to ensure you do want to add the waveform segment to the Multi-Pack. If you attempt to license a waveform that is already licensed using another slot an error is generated. .
Dependencies	This key is only available if the currently selected file is a secure waveform requiring a license, and there is at least one slot available within at least one multi-pack license. If the waveform highlighted is a secure waveform, but is already licensed, this key will be unavailable.
Initial S/W Revision	A.05.00

Segments on Hard Disk

Allows you access to the sub-menus for loading waveform segments from the hard disk into ARB memory. The default directory is: D: varb.

Pressing this key changes the current view to the Waveform Management View.

Key Path	Source, Modulation Setup, ARB, Select Waveform
Initial S/W Revision	A.05.00

Load Segment To ARB Memory

Allows you to load the selected file into ARB memory. On the front panel you select the file for loading to the ARB memory by highlighting the desired file in the list. Using the SCPI command, you specify the file name on the HDD.

“NVWFM” (none-volatile storage) MSUS (Mass Storage Unit Specifier) is supported in the memory subsystem because the ARB memory cannot be accessed directly. Therefore, files must be downloaded to the instrument hard disk and then loaded into the ARB memory. “NVWFM” MSUS will be mapped to the default directory D: VARB. The SCPI command supports using either “NVWFM” MSUS or specifying a full path. For more information, see [Memory Subsystem \(Remote Command Only\)](#).

If a file of the same name already exists within ARB memory, it is overwritten. If you wish to load two segments of the same name, you must rename one of the segments before loading it into ARB memory. To rename a segment, you can either use Windows File Explorer, or the :MMEMory:COPI command.

Key Path	Source, Modulation Setup, ARB, Select Waveform, Segments on Hard Disk
Remote Command	:SOURce:RADio:ARB:LOAD <string>
Example	:SOUR:RAD:ARB:LOAD "D: VARB\testwaveform.bin" or :SOUR:RAD:ARB:LOAD "NVWFM:testwaveform.bin"
Notes	<p>Because loading the file involves a delay of unpredictable length, this command should be followed by the query *OPC?, which holds off subsequent commands until the loading operating is complete.</p> <p><string> – specifies the path name of the file to load from the HDD into ARB memory. It could be a <full path + filename>, or <“NVWFM” MSUS + colon + filename>.</p> <p>When in Sequence Analyzer mode, and Include Source is Yes, an attempt to load a file to ARB memory will be rejected with an error.</p> <p>When Include Source is No and if there is insufficient free ARB memory to load the selected waveform, an error is generated. .</p> <p>If you specify a file over SCPI, but the file is not at the specified location, an error is generated.</p> <p>If you try to load a waveform file but the file contains less than 500 IQ samples, an error is generated.</p> <p>If you try to load a Signal Studio waveform “*.wfm” which contains invalid waveform header, an error is generated.</p> <p>If the ARB is ON when you load a file to ARB memory or delete a file from ARB memory, the playing waveform segment may not keep phase continuity during the ARB memory operation. The waveform will be replayed after the ARB operation is finished.</p> <p>ARB can be loaded into ARB memory even required licenses do not present on the instrument. In this case, a GUI only warning message -800, “Operation complete; Loaded <filename> successfully, but no license <required licenses> installed”. User can install required licenses according to <required licenses> string to license it, or multi-pack license it.</p>
Initial S/W Revision	A.05.00

Load All To ARB Memory

Allows you to load all the segment files within the currently selected directory into ARB memory. If a file of the same name already exists within ARB memory, it is overwritten. If you wish to load two segments of the same name, you must rename one of the segments before loading it into ARB memory. To rename a segment, you can either use Windows File Explorer, or the :MEMory:COpy command.

Key Path	Source, Modulation Setup, ARB, Select Waveform, Segments on Hard Disk
Remote Command	:SOURce:RADio:ARB:LOAD:ALL <string>
Example	:SOUR:RAD:ARB:LOAD:ALL "D: varb"
Notes	<p><string> - specifies the directory on the HDD to load the files into ARB memory from.</p> <p>When in Sequence Analyzer mode, and Include Source is Yes, an attempt to load all files from a directory to ARB memory is rejected with an error.</p> <p>When Include Source is No and there is insufficient free ARB memory to load all the waveforms, when the ARB memory is full, the copy ceases, and an error is generated.</p> <p>If you specify a directory over SCPI, but the directory does not exist, an error is generated.</p> <p>If the ARB is ON, a user then loads or deletes file to ARB memory, the playing waveform segment may not keep phase continuity during the ARB memory operation. The waveform will be replayed after the ARB operation is finished.</p>
Initial S/W Revision	A.05.00

Change Directory...

Allows you to change the currently selected directory on the hard disk. Pressing this key opens a standard windows change directory dialog allowing you to select the new directory of interest.

The current directory is used for manually loading waveform segments into ARB memory for playback, and as a search location for waveform segments that are required to be loaded into ARB memory for playback of a waveform sequence or a list sequence.

Key Path	Source, Modulation Setup, ARB, Select Waveform, Segments on Hard Disk
Notes	No remote command, SCPIfront panel only.
Initial S/W Revision	A.05.00

Default Directory...

Allows you to change the default directory. It is used as a search location for waveform segments that are required to be loaded into ARB memory for playback of a waveform sequence, and as a search location for selecting waveforms using SCPI.

Key Path	Source, Modulation Setup, ARB, Select Waveform, Segments on Hard Disk
Remote Command	:SOURce:RADio:ARB:DEFault:DIRectory <string> :SOURce:RADio:ARB: DEFault:DIRectory?
Example	:SOUR:RAD:ARB:DEF:DIR "D:\ArbFiles"

	:SOUR:RAD:ARB:DEF:DIR?
State Saved	Persistent, survives a power cycle and a preset but not saved in the instrument state
Initial S/W Revision	A.05.00

Segments on Hard Disk

This key functions the same as ["Segments on Hard Disk" on page 738](#).

Key Path	Source, Modulation Setup, ARB, Waveform Utilities, Multi-Pack Licenses, Add Waveform
Initial S/W Revision	Prior to A.09.00

Load Segment To ARB Memory

This key functions the same as ["Load Segment To ARB Memory" on page 738](#).

Key Path	Source, Modulation Setup, ARB, Waveform Utilities, Multi-Pack Licenses, Add Waveform, Segment on Hard Drive
Initial S/W Revision	Prior to A.09.00

Load All To ARB Memory

This key functions the same as ["Load All To ARB Memory" on page 739](#).

Key Path	Source, Modulation Setup, ARB, Waveform Utilities, Multi-Pack Licenses, Add Waveform, Segment on Hard Drive
Initial S/W Revision	Prior to A.09.00

Change Directory ...

This key functions the same as ["Change Directory..." on page 740](#).

Key Path	Source, Modulation Setup, ARB, Waveform Utilities, Multi-Pack Licenses, Add Waveform, Segment on Hard Drive
Initial S/W Revision	Prior to A.09.00

Default Directory ...

This key functions the same as ["Default Directory..." on page 740](#)

Key Path	Source, Modulation Setup, ARB, Waveform Utilities, Multi-Pack Licenses, Add Waveform, Segment on Hard Drive
----------	--

Initial S/W Revision	Prior to A.09.00
----------------------	------------------

Replace Waveform

Pressing this key accesses the Replace Waveform submenu. It also changes the central display area to display the Multi-Pack License Waveform Add view.

Key Path	Source, Modulation Setup, ARB, Waveform Utilities, Multi-Pack Licenses
----------	---

Dependencies	This key is only available if the currently selected slot is in the trial state.
--------------	--

Initial S/W Revision	A.05.00
----------------------	---------

Replace Waveform

Allows you to replace the waveform in the currently selected slot with the waveform currently selected in the Multi-Pack License Waveform Add view.

Key Path	Source, Modulation Setup, ARB, Waveform Utilities, Multi-Pack Licenses, Replace Waveform
----------	---

Remote Command	<code>:SYSTem:LKEY:WAVeform:REPLace <int>, <string></code> or <code>:SYSTem:LIcense[:FPACK]:WAVeform:REPLace <int>, <string></code>
-----------------------	---

Example	<code>SYST:LKEY:WAV:REPL 1, "myotherwaveform.wfm"</code> or <code>:SYST:LIC:WAV:REPL 1, "myotherwaveform.wfm"</code>
----------------	--

Notes	The second SCPI <code>:SYSTem:LIcense[:FPACK]:WAVeform:REPLace</code> is provided to be consistent with the style of Keysight signal sources. You can use either one of them. If you attempt to license a waveform that is already licensed using another slot an error is generated. Waveform slot number <code><int></code> is positive. If you attempt to input a slot number less than or equals 0, an error is generated.
-------	---

Initial S/W Revision	A.05.00
----------------------	---------

Segments on Hard Disk

This key functions the same as ["Segments on Hard Disk" on page 738](#).

Key Path	Source, Modulation Setup, ARB, Waveform Utilities, Multi-Pack Licenses, Replace Waveform
----------	---

Initial S/W Revision	Prior to A.09.00
----------------------	------------------

Load Segment To ARB Memory

This key functions the same as ["Load Segment To ARB Memory" on page 738](#).

Key Path	Source, Modulation Setup, ARB, Waveform Utilities, Multi-Pack Licenses, Replace Waveform, Segment on Hard Drive
Initial S/W Revision	Prior to A.09.00

Load All To ARB Memory

This key functions the same as ["Load All To ARB Memory" on page 739](#).

Key Path	Source, Modulation Setup, ARB, Waveform Utilities, Multi-Pack Licenses, Replace Waveform, Segment on Hard Drive
Initial S/W Revision	Prior to A.09.00

Change Directory ...

This key functions the same as ["Change Directory..." on page 740](#).

Key Path	Source, Modulation Setup, ARB, Waveform Utilities, Multi-Pack Licenses, Replace Waveform, Segment on Hard Drive
Initial S/W Revision	Prior to A.09.00

Default Directory ...

This key functions the same as ["Default Directory..." on page 740](#)

Key Path	Source, Modulation Setup, ARB, Waveform Utilities, Multi-Pack Licenses, Replace Waveform, Segment on Hard Drive
Initial S/W Revision	Prior to A.09.00

Clear Waveform from Slot

Allows you to clear the waveform from the selected slot.

Key Path	Source, Modulation Setup, ARB, Waveform Utilities, Multi-Pack Licenses
Remote Command	:SYSTem:LKEY:WAVeform:CLEar <int> or :SYSTem:LICense[:FPACK]:WAVeform:CLEar <int>
Example	SYST:LKEY:WAV:CLE 1 or :SYST:LIC:WAV:CLE 1
Notes	The second SCPI :SYSTem:LICense[:FPACK]:WAVeform:CLEar is provided to be consistent with the style of Keysight signal sources. You can use either one of them.

Waveform slot number <int> is positive. If you attempt to input a slot number less than or equals 0, an error is generated.

Dependencies	This key is only available if the currently selected slot is in the trial state.
Initial S/W Revision	A.05.00

Lock Waveform in Slot

If the selected slot is in the trial state or the lock required state, the waveform that occupies the slot is locked and permanently licensed.

Key Path	Source, Modulation Setup, ARB, Waveform Utilities, Multi-Pack Licenses
Remote Command	:SYSTem:LKEY:WAVeform:LOCK <int> or :SYSTem:LICense[:FPACK]:WAVeform:LOCK <int>
Example	SYST:LKEY:WAV:LOCK 1 or SYST:LIC:WAV:LOCK 1
Notes	The second SCPI :SYSTem:LICense[:FPACK]:WAVeform:LOCK is provided to be consistent with the style of Keysight signal sources. You can use either one of them. Waveform slot number <int> is positive. If you attempt to input a slot number less than or equals 0, an error is generated.
Dependencies	This key is only available if the currently selected slot is in the trial state or the lock required state.
Initial S/W Revision	A.05.00

Slot Status Query (Remote Command Only)

Returns the status of the specified slot.

Remote Command	:SYSTem:LKEY:WAVeform:STATus? <int> or :SYSTem:LICense[:FPACK]:WAVeform:STATus? <int>
Example	:SYST:LKEY:WAV:STAT? 1 <"Locked" or :SYST:LIC:WAV:STAT? 1 <"Locked"
Notes	The second SCPI :SYSTem:LICense[:FPACK]:WAVeform:STATus is provided to be consistent with the style of Keysight signal sources. You can use either one of them. Waveform slot number <int> is positive. If you attempt to input a slot number less than or equals 0, an

	error is generated. Result type is string. If input slot number exceeds total available slot number, "Nonexistent" is returned.
Range	"Locked" "Available" "Trail" "LockRequired" "Nonexistent"
Initial S/W Revision	A.05.00

Slots Free Query (Remote Command Only)

Returns the number of license slots free.

Remote Command	:SYSTem:LKEY:WAVeform:FREE? or :SYSTem:LIcense[:FPACK]:WAVeform:FREE?
Example	:SYST:LKEY:WAV:FREE? or :SYST:LIC:WAV:FREE?
Notes	The second SCPI :SYSTem:LIcense[:FPACK]:WAVeform:FREE is provided to be consistent with the style of Keysight signal sources. You can use either one of them.
Initial S/W Revision	A.05.00

Slot Used Query (Remote Command Only)

Returns the number of license slots used.

Remote Command	:SYSTem:LKEY:WAVeform:USED? or :SYSTem:LIcense[:FPACK]:WAVeform:USED?
Example	:SYST:LKEY:WAV:USED? or :SYST:LIC:WAV:USED?
Notes	The second SCPI :SYSTem:LIcense[:FPACK]:WAVeform:USED is provided to be consistent with the style of Keysight signal sources. You can use either one of them.
Initial S/W Revision	A.05.00

Slot Waveform Name Query (Remote Command Only)

Returns the waveform name of the specified slot

Remote Command	:SYSTem:LKEY:WAVeform:NAME? <int> or :SYSTem:LIcense[:FPACK]:WAVeform:NAME? <int>
-----------------------	---

Example	:SYST:LKEY:WAV:NAME? 1 <"CDMA2K_22.wfm" or :SYST:LIC:WAV:NAME? 1 <"CDMA2K_22.wfm"
Notes	Waveform slot number <int> is positive. If you attempt to input a slot number less than or equals 0, an error is generated. Result type is string. If input slot number exceeds total available slot number, "Nonexistent" is returned. If no waveform stored in the specified slot, then empty string is returned.
Initial S/W Revision	A.12.00

Slot Waveform Unique ID Query (Remote Command Only)

Returns the waveform unique ID of the specified slot

Remote Command	:SYSTem:LKEY:WAVeform:UID? <int> or :SYSTem:LICense[:FPACK]:WAVeform:UID? <int>
Example	:SYST:LKEY:WAV:UID? 2 <"1346752140" or :SYST:LIC:WAV:UID? 2 <"1346752140"
Notes	Waveform slot number <int> is positive. If you attempt to input a slot number less than or equals 0, an error is generated. Result type is string. If input slot number exceeds total available slot number, "Nonexistent" is returned. If no waveform stored in the specified slot, then "0" is returned
Initial S/W Revision	A.12.00

Locked Waveform Name List Query (Remote Command Only)

Returns the waveform name list of locked.

Remote Command	:SOURce:RADio:ARB:MPLicensed:NAME:LOCKed?
Example	SOUR:RAD:ARB:MPL:NAME:LOCKed? <"CDMA2K_27.wfm", "GSM_MCS1.WFM", "c2kWfm.wfm"
Initial S/W Revision	A.11.00

Locked Waveform Unique ID List Query (Remote Command Only)

Returns the waveform unique id list of locked.

Remote Command	:SOURce:RADio:ARB:MPLicensed:UID:LOCKed?
Example	SOUR:RAD:ARB:MPL:UID:LOCKed? <"2996927136","3812603511","3710986266">
Notes	Each Signal Studio waveform has a unique id recorded in header. So if the unique ids are same, that means they are same one waveform. So besides SCPI to query locked waveform name list, also provide a SCPI to query locked waveform unique id list
Initial S/W Revision	A.11.00

Marker Utilities

Allows access to the marker utilities sub-menus.

Key Path	Source, Modulation Setup, ARB
Initial S/W Revision	A.05.00

Marker Polarity

Allows access to the marker polarity sub-menu, which allows you to specify the polarity for the four markers. For a positive polarity, the marker signal is high during the marker points. For a negative marker polarity, the marker signal is high during the period of no marker points.

Key Path	Source, Modulation Setup, ARB, Marker Utilities
Initial S/W Revision	A.05.00

Mkr 1 Polarity

Allows you to set the polarity of marker 1.

Key Path	Source, Modulation Setup, ARB, Marker Utilities, Marker Polarity
Remote Command	:SOURce:RADio:ARB:MPOLarity:MARKer1 POSitive NEGative :SOURce:RADio:ARB:MPOLarity:MARKer1?
Example	:SOUR:RAD:ARB:MPOL:MARK1 NEG
Dependencies	When a new waveform is selected for playback the settings contained within the associated waveform header file are applied to the ARB. The marker polarity is one of the values stored within the header file. If the newly selected waveform file has an associated header file, the marker polarity is updated with the value from the header file. The marker polarity will remain unchanged if the newly selected waveform does not have an associated header file.
Preset	Pos
Range	Neg Pos
Initial S/W Revision	A.05.00

Mkr 2 Polarity

Allows you to set the polarity of marker 2.

Key Path	Source, Modulation Setup, ARB, Marker Utilities, Marker Polarity
Remote Command	:SOURce:RADio:ARB:MPOLarity:MARKer2 POSitive NEGative :SOURce:RADio:ARB:MPOLarity:MARKer2?
Example	:SOUR:RAD:ARB:MPOL:MARK2 NEG
Dependencies	When a new waveform is selected for playback the settings contained within the associated waveform header file are applied to the ARB. The marker polarity is one of the values stored within the header file. If the newly selected waveform file has an associated header file, the marker polarity is updated with the value from the header file. The marker polarity will remain unchanged if the newly selected waveform does not have an associated header file.
Preset	Pos
Range	Neg Pos
Initial S/W Revision	A.05.00

Mkr 3 Polarity

Allows you to set the polarity of marker 3.

Key Path	Source, Modulation Setup, ARB, Marker Utilities, Marker Polarity
Remote Command	:SOURce:RADio:ARB:MPOLarity:MARKer3 POSitive NEGative :SOURce:RADio:ARB:MPOLarity:MARKer3?
Example	:SOUR:RAD:ARB:MPOL:MARK3 NEG
Dependencies	When a new waveform is selected for playback the settings contained within the associated waveform header file are applied to the ARB. The marker polarity is one of the values stored within the header file. If the newly selected waveform file has an associated header file, the marker polarity is updated with the value from the header file. The marker polarity will remain unchanged if the newly selected waveform does not have an associated header file.
Preset	Pos
Range	Neg Pos
Initial S/W Revision	A.05.00

Mkr 4 Polarity

Allows you to set the polarity of marker 4.

Key Path	Source, Modulation Setup, ARB, Marker Utilities, Marker Polarity
Remote Command	:SOURce:RADio:ARB:MPOLarity:MARKer4 POSitive NEGative :SOURce:RADio:ARB:MPOLarity:MARKer4?

Example	:SOUR:RAD:ARB:MPOL:MARK4 NEG
Dependencies	When a new waveform is selected for playback the settings contained within the associated waveform header file are applied to the ARB. The marker polarity is one of the values stored within the header file. If the newly selected waveform file has an associated header file, the marker polarity is updated with the value from the header file. The marker polarity will remain unchanged if the newly selected waveform does not have an associated header file.
Preset	Pos
Range	Neg Pos
Initial S/W Revision	A.05.00

Marker Routing

Allows access to the marker routing sub-menus, which allow you to specify where the marker events are routed. It should be noted that the markers can also be routed to Trigger 1 Out and Trigger 2 Out, however this must be set up using the menus accessed by pressing the “Trigger” hard key.

Key Path	Source, Modulation Setup, ARB, Marker Utilities
Initial S/W Revision	A.05.00

Pulse/RF Blank

Allows you to select which marker is used for the pulse/RF blanking function. The pulse/RF blanking function blanks the RF when the marker signal goes low. The marker polarity determines when the marker signal is high. For a positive polarity, this is during the marker points. For a negative polarity, this is when there are no marker points.

Marker points should be set before using this function. Enabling this function without setting maker points may create a continuous low or high signal, dependant on the marker polarity. This causes either no RF output, or a continuous RF output.

Key Path	Source, Modulation Setup, ARB, Marker Utilities, Marker Routing
Remote Command	:SOURce:RADio:ARB:MDEStination:PULSe NONE M1 M2 M3 M4 :SOURce:RADio:ARB:MDEStination:PULSe?
Example	:SOUR:RAD:ARB:MDES:PULS NONE
Dependencies	When a new waveform is selected for playback the settings contained within the associated waveform header file are applied to the ARB. The pulse/RF blanking setting is one of the values stored within the header file. If the newly selected waveform file has an associated header file, the pulse/RF blanking setting is updated with the value from the header file. The pulse/RF blanking setting will remain unchanged if the newly selected waveform does not have an associated header file.
Range	None M1 M2 M3 M4
Initial S/W Revision	A.05.00

None

Sets no marker to be used for the pulse/RF blanking function, essentially turning the RF blanking function off.

Key Path	Source, Modulation Setup, ARB, Marker Utilities, Marker Routing, Pulse/RF Blank
Example	:SOUR:RAD:ARB:MDES:PULS NONE
Initial S/W Revision	A.05.00

Marker 1

Sets marker 1 to be used for the pulse/RF blanking function.

Key Path	Source, Modulation Setup, ARB, Marker Utilities, Marker Routing, Pulse/RF Blank
Example	:SOUR:RAD:ARB:MDES:PULS M1
Initial S/W Revision	A.05.00

Marker 2

Sets marker 2 to be used for the pulse/RF blanking function.

Key Path	Source, Modulation Setup, ARB, Marker Utilities, Marker Routing, Pulse/RF Blank
Example	:SOUR:RAD:ARB:MDES:PULS M2
Initial S/W Revision	A.05.00

Marker 3

Sets marker 3 to be used for the pulse/RF blanking function.

Key Path	Source, Modulation Setup, ARB, Marker Utilities, Marker Routing, Pulse/RF Blank
Example	:SOUR:RAD:ARB:MDES:PULS M3
Initial S/W Revision	A.05.00

Marker 4

Sets marker 4 to be used for the pulse/RF blanking function.

Key Path	Source, Modulation Setup, ARB, Marker Utilities, Marker Routing, Pulse/RF Blank
Example	:SOUR:RAD:ARB:MDES:PULS M4
Initial S/W Revision	A.05.00

ALC Hold

Allows you to specify which marker is routed for use within the ALC hold function. The ALC hold marker function holds the ALC circuitry at the average value of the sample points set by the marker.

The ALC hold function operates during the low periods of the marker signal. The marker polarity determines when the marker signal is high. For positive polarity, this is during the marker points. For a negative polarity, this is when there are no marker points.

Key Path	Source, Modulation Setup, ARB, Marker Utilities, Marker Routing
Remote Command	:SOURce:RADio:ARB:MDEStination:ALCHold NONE M1 M2 M3 M4 :SOURce:RADio:ARB:MDEStination:ALCHold?
Example	:SOUR:RAD:ARB:MDES:ALCH NONE
Dependencies	When a new waveform is selected for playback the settings contained within the associated waveform header file are applied to the ARB. The ALC hold setting is one of the values stored within the header file. If the newly selected waveform file has an associated header file, the ALC hold setting is updated with the value from the header file. The ALC hold setting will remain unchanged if the newly selected waveform does not have an associated header file.
Range	None M1 M2 M3 M4
Initial S/W Revision	A.05.00

None

Sets no marker to be used for the ALC hold function, essentially turning the ALC hold function off.

Key Path	Source, Modulation Setup, ARB, Marker Utilities, Marker Routing, ALC Hold
Example	:SOUR:RAD:ARB:MDES:PULS NONE
Initial S/W Revision	A.05.00

Marker 1

Sets marker 1 to be used for the ALC hold function.

Key Path	Source, Modulation Setup, ARB, Marker Utilities, Marker Routing, ALC Hold
Example	:SOUR:RAD:ARB:MDES:PULS M1
Initial S/W Revision	A.05.00

Marker 2

Sets marker 2 to be used for the ALC hold function.

Key Path	Source, Modulation Setup, ARB, Marker Utilities, Marker Routing, ALC Hold
Example	:SOUR:RAD:ARB:MDES:PULS M2
Initial S/W Revision	A.05.00

Marker 3

Sets marker 3 to be used for the ALC hold function.

Key Path	Source, Modulation Setup, ARB, Marker Utilities, Marker Routing, ALC Hold
Example	:SOUR:RAD:ARB:MDES:PULS M3
Initial S/W Revision	A.05.00

Marker 4

Sets marker 4 to be used for the ALC hold function.

Key Path	Source, Modulation Setup, ARB, Marker Utilities, Marker Routing, ALC Hold
Example	:SOUR:RAD:ARB:MDES:PULS M4
Initial S/W Revision	A.05.00

Header Utilities

Allows access to the header utilities sub-menu. Pressing this key also causes the central display area to change to display the File Header Information view.

Key Path	Source, Modulation Setup, ARB
Dependencies	This key is only available if there is currently a waveform selected for playback. If no waveform is selected, the key is grayed out.
Initial S/W Revision	A.05.00

Clear Header

Allows you to clear the header information from the file header associated with the currently selected waveform.

Key Path	Source, Modulation Setup, ARB, Header Utilities
Remote Command	:SOURce:RADio:ARB:HEADer:CLEar
Example	:SOUR:RAD:ARB:HEAD:CLE
Notes	Attempting to clear the header details via SCPI when no waveform was selected for playback will generate an error.
Initial S/W Revision	A.05.00

Save Setup To Header

Allows you to save new file header information details to the file.

Key Path	Source, Modulation Setup, ARB, Header Utilities
Remote Command	:SOURce:RADio:ARB:HEADer:SAVE
Example	:SOUR:RAD:ARB:HEAD:SAVE
Notes	Attempting to save the header details via SCPI when no waveform was selected for playback will generate an error.
Initial S/W Revision	A.05.00
Modified at S/W Revision	A.16.00 (AWGN settings will be saved to header as well)

Query Waveform Unique ID (Remote Command Only)

Each Signal Studio waveform contains a unique waveform ID, which recorded in the header. This command allows you to query the unique waveform ID from the header. This is a SCPI only command. User can also check [Error! Reference source not found.](#) for waveform unique ID display.

Remote Command	:MMEMory:HEADer:ID? "<file name>"
Example	:MMEM:HEAD:ID? "test.wfm" (query the waveform already loaded into the ARB memory) :MMEM:HEAD:ID? "D: VARB\test.wfm" (query the waveform on the hard disk by absolute path) :MMEM:HEAD:ID? "NVWFM:test.wfm" (query the waveform on the hard disk by MSUS)
Notes	SCPI query only. The queried waveform file can be in ARB memory, or on hard disk. If want to query ARB in ARB memory, then give out the file name directly. If want to query ARB on the hard disk, then absolute file path or MSUS should be given along with the file name. The valid MSUS is "NVWFM" which is mapped to D: VARB on hard disk. If the file cannot be found in ARB memory or on hard disk, an error is generated.and value -1 is returned
Initial S/W Revision	A.09.00

Bus Trigger Command (Remote Command Only)

Used to initiate an immediate trigger event if the trigger source is set to Bus.

Remote Command	:SOURce:RADio:ARB:TRIGger:INITiate
Example	:SOUR:RAD:ARB:TRIG:INIT
Initial S/W Revision	A.05.00

AM

Allows access to the menu for configuring the Amplitude Modulation.

Key Path	Source, Modulation Setup
Initial S/W Revision	A.05.00

AM

Enables or disables the amplitude modulation.

Turning AM on when another modulation format is already on results in the previous modulation format being turned off and the generation of an error.

Key Path	Source, Modulation Setup, AM
Remote Command	:SOURce:AM:STATe :SOURce:AM:STATe?
Example	:SOUR:AM:STAT OFF
Preset	Off
Range	On Off
Initial S/W Revision	A.05.00

AM Depth

Allows you to set the amplitude modulation depth in percent.

Key Path	Source, Modulation Setup, AM
Remote Command	:SOURce:AM[:DEPTh] [:LINear] :SOURce:AM[:DEPTh] [:LINear]?
Example	:SOUR:AM 0.1
Preset	0.1 %
Min	0.1 %
Max	95.0 %
Initial S/W Revision	A.05.00

AM Rate

Allows you to set the internal amplitude modulation rate.

Key Path	Source, Modulation Setup, AM
Remote Command	:SOURce:AM:INTernal:FREQuency :SOURce:AM:INTernal:FREQuency?
Example	:SOUR:AM:INT:FREQ 40.0 Hz

Preset	400.0 Hz
Min	10 Hz
Max	40 kHz
Initial S/W Revision	A.05.00

FM

Allows access to the menu for configuring the frequency modulation.

Key Path	Source, Modulation Setup
Initial S/W Revision	A.05.00

FM

Enables or disables the frequency modulation.

Turning FM on when another modulation format is already on results in the previous modulation format being turned off and the generation of an error.

Key Path	Source, Modulation Setup, FM
Remote Command	:SOURce:FM:STATe :SOURce:FM:STATe?
Example	:SOUR:FM:STAT OFF
Preset	Off
Range	On Off
Initial S/W Revision	A.05.00

FM Deviation

Allows you to set the frequency modulation deviation.

Key Path	Source, Modulation Setup, FM
Remote Command	:SOURce:FM[:DEViation] :SOURce:FM[:DEViation]?
Example	:SOUR:FM 1.00 kHz
Preset	1.00 Hz
Min	1.00 Hz
Max	100.00 kHz
Initial S/W Revision	A.05.00

FM Rate

Allows you to set the internal frequency modulation rate.

Key Path	Source, Modulation Setup, FM
Remote Command	:SOURce:FM:INTernal:FREQuency :SOURce:FM:INTernal:FREQuency?
Example	:SOUR:FM:INT:FREQ 40.0 Hz
Preset	400.0 Hz
Min	10 Hz
Max	40 kHz
Initial S/W Revision	A.05.00

PM

Allows access to the menu for configuring the phase modulation.

Key Path	Source, Modulation Setup
Initial S/W Revision	A.05.00

PM

Enables or disables the phase modulation.

Turning PM on when another modulation format is already on results in the previous modulation format being turned off and the generation of an error.

Key Path	Source, Modulation Setup, PM
Remote Command	:SOURce:PM:STATe :SOURce:PM:STATe?
Example	:SOUR:PM:STAT OFF
Preset	Off
Range	On Off
Initial S/W Revision	A.05.00

PM Deviation

Allows you to set the phase modulation deviation.

Key Path	Source, Modulation Setup, PM
Remote Command	:SOURce:PM[:DEVIation] :SOURce:PM[:DEVIation]?

Example	:SOUR:PM 1.00 rad
Preset	0.1 rad
Min	0.1 rad
Max	20.0 rad
Initial S/W Revision	A.05.00

PM Rate

Allows you to set the internal phase modulation rate.

Key Path	Source, Modulation Setup, PM
Remote Command	:SOURce:PM:INTernal:FREQuency :SOURce:PM:INTernal:FREQuency?
Example	:SOUR:PM:INT:FREQ 40.0 Hz
Preset	400.0 Hz
Min	10 Hz
Max	40 kHz
Initial S/W Revision	A.05.00

List Sequencer

Allows you access to the sub-menus for configuring the list sequencer.

List sequences allows you to enter frequencies and amplitudes at unequal intervals in nonlinear ascending, descending or random order. Each step within the list can also include its own waveform file for playback, step duration, trigger event and trigger output.

The complexities involved in configuring the list sequencer do not lend itself to manual configuration; hence the manual configuration for this feature is limited. For easier configuration of the list sequencer, it is recommended that you use either SCPI or load a tab delimited file containing the setup parameters in a tabular form. The details of the SCPI for configuring the list sequencer can be found in "[Step Configuration \(Remote Command Only\)](#)" on page 746.

Once the List Sequencer has been configured using the front panel, SCPI, or loading in a tab delimited file, the sequence must be initiated using the front panel Initiate Sequence key or the corresponding SCPI command.

Key Path	Source
Initial S/W Revision	A.05.00

Sequencer

Allows you to set the state of the list sequencer. When the list sequencer is on, the source is outputting the sequence defined by the sequencer. When the list sequencer is off, the source outputs a single waveform segment or sequence (independent mode) at a single frequency and amplitude.

Key Path	Source, List Sequencer
Remote Command	:SOURce:LIST[:STATe] ON OFF 1 0 :SOURce:LIST[:STATe]?
Example	:SOUR:LIST OFF
Notes	When the sequencer is set to ON, the list sequencer controls the output of the source.
Couplings	When in Sequence Analyzer mode and the list sequencer state is Off, Include Source is forced to No, and the Include Source key is grayed out. When in Sequence Analyzer mode and the list sequencer state is On, Include Source is available to set. And, an ARB memory related operation, like load or delete will be rejected.
Preset	Off
Range	On Off
Initial S/W Revision	A.05.00

Initiate Sequence

Pressing this key arms the sequence for single execution. Once the sequence is armed the source begins the sequence as soon as the trigger is received. If the trigger is set to Free Run, the sequence starts immediately.

Key Path	Source, List Sequencer
Remote Command	:SOURce:LIST:TRIGger[:IMMediate]
Example	:SOUR:LIST:TRIG
Notes	When in Sequence Analyzer mode and Include Source is Yes, the Initiate list sequencer operation is rejected, and the key is grayed out, since source list sequence request is sent to physics via Parallel batch by sequence analyzer. If the file needed by the sequencer is not already in ARB memory, the sequence cannot be initiated and an error will be generated. There is a blocking SCPI query which can be used to query if source list sequence being initiated successfully or not. (see " Query List Sequence Initiation Armed Status (Remote Command Only) " on page 757 Query Source List Sequence Armed Status)
Dependencies	Under the Sequence Analyzer Mode, if Meas Setup->Include Source is set to YES, Source->List Sequencer->Initiate Sequence is disabled.
Initial S/W Revision	A.05.00

List Sequencer Setup

Allows you access to the list sequencer setup menus.

Key Path	Source, List Sequencer
----------	-------------------------------

Number of Steps

Allows you to specify the number of steps within the list sequence.

Key Path	Source, List Sequencer, List Sequencer Setup
Remote Command	:SOURce:LIST:NUMBer:STEPs <integer> :SOURce:LIST:NUMBer:STEPs?
Example	:SOUR:LIST:NUMB:STEP 1
Notes	Increasing the number of steps creates additional steps at the end of the list, with all the settings within the steps set to their default values. Decreasing the number of steps removes steps from the end of the list. The settings within the removed steps are not reset. This means that increasing the number of steps again would allow you to retrieve these steps.
Dependencies	The Step Count parameter is increased or decreased when you insert or delete a point from within the GUI interface to the sequencer.
Preset	1
Min	1
Max	1000
Initial S/W Revision	A.05.00

Current Step

Allows you to select the step number you wish to view or edit.

Key Path	Source, List Sequencer, List Sequencer Setup
Notes	No remote command, front panel only.
Preset	1
Min	1
Max	Step Count
Initial S/W Revision	A.05.00

Insert Step Before

Allows you to insert a new step, containing default values, before the currently selected step. Inserting a step will automatically increase the Step Count parameter by 1. If sequence already reaches upper limit of

1000 steps, then insert more step will be rejected and popup error –221, “Setting Conflict; Cannot insert more steps, maximum number of steps reached”

Key Path	Source, List Sequencer, List Sequencer Setup
Notes	No remote command, front panel only. If the list already contains the maximum limit of 1000 steps, no operation will be made after pressing this key.
Initial S/W Revision	A.05.00

Delete Step

Allows you to delete the current step. Deleting a step will automatically decrease the Step Count parameter by 1. If sequence only has one step left, delete step will be rejected and popup error –221, “Setting conflict; Cannot delete current step, minimum number of steps reached”

Key Path	Source, List Sequencer, List Sequencer Setup
Notes	No remote command, Front Panel key only. If the list already contains the minimum limit of 1 step, no operation will be made after pressing this key
Initial S/W Revision	A.05.00

Clear List

Allows you to clear the list. Clearing the list sets the number of steps to the default value of 1 and sets the parameters for the only step to their default values.

Key Path	Source, List Sequencer, List Sequencer Setup
Initial S/W Revision	A.05.00

Step Trigger

Allows access to the sub-menu for selecting the trigger input for the current step.

Key Path	Source, List Sequencer, List Sequencer Setup
Remote Command	:SOURce:LIST:STEP[1] 2 3...1000:SETup:INPut:TRIGger IMMEDIATE INTERNAL EXTERNAL2 KEY BUS EXTERNAL4 :SOURce:LIST:STEP[1] 2 3...1000:SETup:INPut:TRIGger?
Example	:SOUR:LIST:STEP2:SET:INP:TRIG BUS :SOUR:LIST:STEP2:SET:INP:TRIG?
Notes	SCPI is supported after A.09.40
Preset	Free Run
Range	Free Run Internal Manual (Trigger Key) Bus External 2 EXTERNAL4
Initial S/W Revision	A.05.00

Free Run

Sets the trigger input for the current step to Free Run.

Key Path	Source, List Sequencer, List Sequencer Setup, Step Trigger
Example	:SOUR:LIST:STEP2:SET:INP:TRIG IMM
Notes	SCPI is supported after A.09.40
Initial S/W Revision	A.05.00

Internal

Sets the trigger input for the current step to Internal.

Key Path	Source, List Sequencer, List Sequencer Setup, Step Trigger
Example	:SOUR:LIST:STEP2:SET:INP:TRIG INT
Notes	SCPI is supported after A.09.40
Initial S/W Revision	A.05.00

Manual (Trigger Key)

Sets the trigger input for the current step to Manual (Trigger Key). Any step in the sequence set to Manual will cause the sequence execution to stop until the manual trigger key is pressed. Sending the Bus Trigger SCPI command will have no effect. At any point in the sequence where the list sequencer is paused waiting for a software trigger, a pop up dialog is displayed until the trigger event occurs.

Key Path	Source, List Sequencer, List Sequencer Setup, Step Trigger
Example	:SOUR:LIST:STEP2:SET:INP:TRIG KEY
Notes	SCPI is supported after A.09.40
Initial S/W Revision	A.05.00

Bus

Sets the trigger input for the current step to Bus. Any step in the sequence set to Bus will cause the sequence execution to stop until the Bus Trigger SCPI command is sent. Pressing the manual trigger key has no effect. At any point in the sequence where the list sequencer is paused waiting for a software trigger, a pop up dialog is displayed until the trigger event occurs.

Key Path	Source, List Sequencer, List Sequencer Setup, Step Trigger
Example	:SOUR:LIST:STEP2:SET:INP:TRIG BUS
Notes	SCPI is supported after A.09.40
Initial S/W Revision	A.05.00

External 2

Sets the trigger input for the current step to External 2.

Key Path	Source, List Sequencer, List Sequencer Setup, Step Trigger
Example	:SOUR:LIST:STEP2:SET:INP:TRIG EXT2
Notes	SCPI is supported after A.09.40
Notes	Note: When on E6640A, trigger 2 is a bi-directional trigger port. So when trigger 2 has been configured as OUTPUT type, choosing External 2 as the input trigger for the current step will generate error.
Initial S/W Revision	A.05.00

Transition Time

Allows you to specify the transition time for the current step.

The transition time is the amount of time allowed for the source to settle at the current frequency or amplitude value.

Transition Time should not be taken as additional time before or inside the Step Duration. You can set a value for the settling time to allow the source output frequency or amplitude to become stable. Make sure that during this period of time, you do not use the source output signal.

The following table lists recommended values for appropriate settling times to allow for changes within the source.

Value Changed	Recommended Transition Time
Frequency	500 μ s
Amplitude	100 μ s to within 0.1 dB 20 μ s to within 1.0 dB

If the Transition Time value is shorter than the time necessary for the hardware to settle and a List Sequence is initiated, a **warning** is generated.

If the Transition Time value is longer than the Step Duration, an error is generated when initiating a source list sequence. For source list sequence, transition time is included in the step duration length. If the Transition Time value is longer than the Step Duration Time, the real step duration length is extended to equal the transition time and cause a timing shift.

Key Path	Source, List Sequencer, List Sequencer Setup
Remote Command	:SOURce:LIST:STEP[1] 2 3...1000:SETup:TRANSition:TIME <time> :SOURce:LIST:STEP[1] 2 3...1000:SETup:TRANSition:TIME?
Example	:SOUR:LIST:STEP2:SET:TRAN:TIME 1ms :SOUR:LIST:STEP2:SET:TRAN:TIME?

Notes	SCPI is supported after A.09.40
Preset	1.0 ms
Min	0.0 ms
Max	4.0 ks
Initial S/W Revision	A.05.00

Radio Setup

Allows you access to the sub-menus for setting up the radio standard, band, and radio band link direction for the current step.

Key Path	Source, List Sequencer, List Sequencer Setup
Notes	No remote command, front panel only.
Initial S/W Revision	A.05.00

Radio Standard

Allows access to the sub-menus for selecting the radio standard and the associated radio band for use in the current step.

Key Path	Source, List Sequencer, List Sequencer Setup, Radio Setup
Remote Command	:SOURce:LIST:STEP[1] 2 3...1000:SETup:RADio:BAND NONE PGSM EGSM RGSM DCS1800 PCS1900 TGSM810 GSM450 GSM480 GSM700 GSM850 BANDI BANDII BANDIII BANDIV BANDV BANDVI BANDVII BANDVIII BANDIX BANDX BANDXI BANDXII BANDXIII BANDXIV BANDXIX USCELL USPCS JAPAN KOREAN NMT IMT2K UPPER SECOND PAMR400 PAMR800 IMTEXT PCS1DOT9G AWS US2DOT5G PUBLIC LOWER NONE BAND1 BAND2 BAND3 BAND4 BAND5 BAND6 BAND7 BAND8 BAND10 BAND11 BAND12 BAND13 BAND14 BAND17 BAND18 BAND19 BAND20 BAND21 BAND24 BAND25 BAND26 BAND27 BAND28 BAND29 BAND30 BAND31 BAND33 BAND34 BAND35 BAND36 BAND37 BAND38 BAND39 BAND40 BAND41 BAND42 BAND43 BAND44 BANDA BANDB BANDC BANDD BANDE BANDF :SOURce:LIST:STEP[1] 2 3...1000:SETup: RADio:BAND?
Example	:SOUR:LIST:STEP2:SET:RAD:BAND PGSM :SOUR:LIST:STEP2:SET:RAD:BAND?
Notes	SCPI is supported after A.09.40
Initial S/W Revision	A.05.00

None

Selects no radio standard for use on the current step.

Key Path	Source, List Sequencer, List Sequencer Setup, Radio Setup, Radio Standard
Example	:SOUR:LIST:STEP2:SET:RAD:BAND NONE
Notes	SCPI is supported after A.09.40
Initial S/W Revision	A.05.00

GSM/EDGE

Pressing this key once selects GSM/EDGE as the radio standard and the current GSM/EDGE band as the active channel band. Pressing this key again allows access to the sub-menus for selecting a different GSM/EDGE band.

Key Path	Source, List Sequencer, List Sequencer Setup, Radio Setup, Radio Standard
Initial S/W Revision	A.05.00

P-GSM

Selects P-GSM as the band for the current step.

Key Path	Source, List Sequencer, List Sequencer Setup, Radio Setup, Radio Standard, GSM/EDGE
Initial S/W Revision	A.05.00

E-GSM

Selects E-GSM as the band for the current step.

Key Path	Source, List Sequencer, List Sequencer Setup, Radio Setup, Radio Standard, GSM/EDGE
Initial S/W Revision	A.05.00

R-GSM

Selects R-GSM as the band for the current step.

Key Path	Source, List Sequencer, List Sequencer Setup, Radio Setup, Radio Standard, GSM/EDGE
Initial S/W Revision	A.05.00

DCS 1800

Selects DCS 1800 as the band for the current step.

Key Path	Source, List Sequencer, List Sequencer Setup, Radio Setup, Radio Standard, GSM/EDGE
Initial S/W Revision	A.05.00

PCS 1900

Selects PCS 1900 as the band for the current step.

Key Path	Source, List Sequencer, List Sequencer Setup, Radio Setup, Radio Standard, GSM/EDGE
Initial S/W Revision	A.05.00

GSM 450

Selects GSM 450 as the band for the current step.

Key Path	Source, List Sequencer, List Sequencer Setup, Radio Setup, Radio Standard, GSM/EDGE
Initial S/W Revision	A.05.00

GSM 480

Selects GSM 480 as the band for the current step.

Key Path	Source, List Sequencer, List Sequencer Setup, Radio Setup, Radio Standard, GSM/EDGE
Initial S/W Revision	A.05.00

GSM 850

Selects GSM 850 as the band for the current step.

Key Path	Source, List Sequencer, List Sequencer Setup, Radio Setup, Radio Standard, GSM/EDGE
Initial S/W Revision	A.05.00

GSM 700

Selects GSM 700 as the band for the current step.

Key Path	Source, List Sequencer, List Sequencer Setup, Radio Setup, Radio Standard, GSM/EDGE
Initial S/W Revision	A.05.00

T-GSM 810

Selects T-GSM 810 as the band for the current step.

Key Path	Source, List Sequencer, List Sequencer Setup, Radio Setup, Radio Standard, GSM/EDGE
Initial S/W Revision	A.05.00

WCDMA

Pressing this key once selects WCDMA as the radio standard and the current WCDMA band as the active channel band. Pressing this key again allows access to the sub-menus for selecting a different WCDMA band.

Key Path	Source, List Sequencer, List Sequencer Setup, Radio Setup, Radio Standard
Initial S/W Revision	A.05.00

Band I

Selects Band I as the band for the current step.

Key Path	Source, List Sequencer, List Sequencer Setup, Radio Setup, Radio Standard, WCDMA
Initial S/W Revision	A.05.00

Band II

Selects Band II as the band for the current step.

Key Path	Source, List Sequencer, List Sequencer Setup, Radio Setup, Radio Standard, WCDMA
Initial S/W Revision	A.05.00

Band III

Selects Band III as the band for the current step.

Key Path	Source, List Sequencer, List Sequencer Setup, Radio Setup, Radio Standard, WCDMA
Initial S/W Revision	A.05.00

Band IV

Selects Band IV as the band for the current step.

Key Path	Source, List Sequencer, List Sequencer Setup, Radio Setup, Radio Standard, WCDMA
Initial S/W Revision	A.05.00

Band V

Selects Band V as the band for the current step.

Key Path	Source, List Sequencer, List Sequencer Setup, Radio Setup, Radio Standard, WCDMA
Initial S/W Revision	A.05.00

Band VI

Selects Band VI as the band for the current step.

Key Path	Source, List Sequencer, List Sequencer Setup, Radio Setup, Radio Standard, WCDMA
Initial S/W Revision	A.05.00

Band VII

Selects Band VII as the band for the current step.

Key Path	Source, List Sequencer, List Sequencer Setup, Radio Setup, Radio Standard, WCDMA
Initial S/W Revision	A.05.00

Band VIII

Selects Band VIII as the band for the current step.

Key Path	Source, List Sequencer, List Sequencer Setup, Radio Setup, Radio Standard, WCDMA
Initial S/W Revision	A.05.00

Band IX

Selects Band IX as the band for the current step.

Key Path	Source, List Sequencer, List Sequencer Setup, Radio Setup, Radio Standard, WCDMA
Initial S/W Revision	A.05.00

Band X

Selects Band X as the band for the current step.

Key Path	Source, List Sequencer, List Sequencer Setup, Radio Setup, Radio Standard, WCDMA
Initial S/W Revision	A.05.00

Band XI

Selects Band XI as the band for the current step.

Key Path	Source, List Sequencer, List Sequencer Setup, Radio Setup, Radio Standard, WCDMA
Initial S/W Revision	A.05.00

Band XII

Selects Band XII as the band for the current step.

Key Path	Source, List Sequencer, List Sequencer Setup, Radio Setup, Radio Standard, WCDMA
Initial S/W Revision	A.05.00

Band XIII

Selects Band XIII as the band for the current step.

Key Path	Source, List Sequencer, List Sequencer Setup, Radio Setup, Radio Standard, WCDMA
Initial S/W Revision	A.05.00

Band XIV

Selects Band XIV as the band for the current step.

Key Path	Source, List Sequencer, List Sequencer Setup, Radio Setup, Radio Standard, WCDMA
Initial S/W Revision	A.05.00

CDMA 2000 / 1xEVDO

Pressing this key once selects CDMA 2000/1xEVDO as the radio standard and the current CDMA 2000/1xEVDO band as the active channel band. Pressing this key again allows access to the sub-menus for selecting a different CDMA 2000/1xEVDO band.

Key Path	Source, List Sequencer, List Sequencer Setup, Radio Setup, Radio Standard
Initial S/W Revision	A.05.00

US CELL

Selects US Cell as the band for the current step.

Key Path	Source, List Sequencer, List Sequencer Setup, Radio Setup, Radio Standard, CDMA 2000 / 1xEVDO
Initial S/W Revision	A.05.00

US PCS

Selects US PCS as the band for the current step.

Key Path	Source, List Sequencer, List Sequencer Setup, Radio Setup, Radio Standard, CDMA 2000 / 1xEVDO
Initial S/W Revision	A.05.00

Japan Cell

Selects Japan Cell as the band for the current step.

Key Path	Source, List Sequencer, List Sequencer Setup, Radio Setup, Radio Standard, CDMA 2000 / 1xEVDO
Initial S/W Revision	A.05.00

Korean PCS

Selects Korean PCS as the band for the current step.

Key Path	Source, List Sequencer, List Sequencer Setup, Radio Setup, Radio Standard, CDMA 2000 / 1xEVDO
Initial S/W Revision	A.05.00

NMT 450

Selects NMT 450 as the band for the current step.

Key Path	Source, List Sequencer, List Sequencer Setup, Radio Setup, Radio Standard, CDMA 2000 / 1xEVDO
Initial S/W Revision	A.05.00

IMT 2000

Selects IMT 2000 as the band for the current step.

Key Path	Source, List Sequencer, List Sequencer Setup, Radio Setup, Radio Standard, CDMA 2000 / 1xEVDO
Initial S/W Revision	A.05.00

Upper 700

Selects Upper 700 as the band for the current step.

Key Path	Source, List Sequencer, List Sequencer Setup, Radio Setup, Radio Standard, CDMA 2000 / 1xEVDO
Initial S/W Revision	A.05.00

Secondary 800

Selects Secondary 800 as the band for the current step.

Key Path	Source, List Sequencer, List Sequencer Setup, Radio Setup, Radio Standard, CDMA 2000 / 1xEVDO
Initial S/W Revision	A.05.00

400 Euro PAMR

Selects 400 Euro PAMR as the band for the current step.

Key Path	Source, List Sequencer, List Sequencer Setup, Radio Setup, Radio Standard, CDMA 2000 / 1xEVDO
Initial S/W Revision	A.05.00

800 PAMR

Selects 800 PAMR as the band for the current step.

Key Path	Source, List Sequencer, List Sequencer Setup, Radio Setup, Radio Standard, CDMA 2000 / 1xEVDO
Initial S/W Revision	A.05.00

2.5GHz IMT EXT

Selects 2.5 GHz IMT EXT as the band for the current step.

Key Path	Source, List Sequencer, List Sequencer Setup, Radio Setup, Radio Standard, CDMA 2000 / 1xEVDO
Initial S/W Revision	A.05.00

US PCS 1.9GHz

Selects US PCS 1.9 GHz as the band for the current step.

Key Path	Source, List Sequencer, List Sequencer Setup, Radio Setup, Radio Standard, CDMA 2000 / 1xEVDO
Initial S/W Revision	A.05.00

AWS

Selects AWS as the band for the current step.

Key Path	Source, List Sequencer, List Sequencer Setup, Radio Setup, Radio Standard, CDMA 2000 / 1xEVDO
Initial S/W Revision	A.05.00

US 2.5GHz

Selects US 2.5 GHz as the band for the current step.

Key Path	Source, List Sequencer, List Sequencer Setup, Radio Setup, Radio Standard, CDMA 2000 / 1xEVDO
Initial S/W Revision	A.05.00

700 Public Safety

Selects 700 Public Safety as the band for the current step.

Key Path	Source, List Sequencer, List Sequencer Setup, Radio Setup, Radio Standard, CDMA 2000 / 1xEVDO
Initial S/W Revision	A.05.00

C2K Lower 700

Selects C2K Lower 700 as the band for the current step.

Key Path	Source, List Sequencer, List Sequencer Setup, Radio Setup, Radio Standard, CDMA 2000 / 1xEVDO
Initial S/W Revision	A.05.00

LTE

Pressing this key once selects LTE FDD as the radio standard and the current LTE FDD band as the active channel band. Pressing this key again allows access to the sub-menus for selecting a different LTE FDD band.

Key Path	Source, List Sequencer, List Sequencer Setup, Radio Setup, Radio Standard
Initial S/W Revision	A.09.50

BAND 1

Selects BAND 1 as the band for the current step.

Key Path	Source, List Sequencer, List Sequencer Setup, Radio Setup, Radio Standard, LTE
Initial S/W Revision	A.09.50

BAND 2

Selects BAND 2 as the band for the current step.

Key Path	Source, List Sequencer, List Sequencer Setup, Radio Setup, Radio Standard, LTE
Initial S/W Revision	A.09.50

BAND 3

Selects BAND 3 as the band for the current step.

Key Path	Source, List Sequencer, List Sequencer Setup, Radio Setup, Radio Standard, LTE
Initial S/W Revision	A.09.50

BAND 4

Selects BAND 4 as the band for the current step.

Key Path	Source, List Sequencer, List Sequencer Setup, Radio Setup, Radio Standard, LTE
Initial S/W Revision	A.09.50

BAND 5

Selects BAND 5 as the band for the current step.

Key Path	Source, List Sequencer, List Sequencer Setup, Radio Setup, Radio Standard, LTE
Initial S/W Revision	A.09.50

BAND 6

Selects BAND 6 as the band for the current step.

Key Path	Source, List Sequencer, List Sequencer Setup, Radio Setup, Radio Standard, LTE
Initial S/W Revision	A.09.50

BAND 7

Selects BAND 7 as the band for the current step.

Key Path	Source, List Sequencer, List Sequencer Setup, Radio Setup, Radio Standard, LTE
Initial S/W Revision	A.09.50

BAND 8

Selects BAND 8 as the band for the current step.

Key Path	Source, List Sequencer, List Sequencer Setup, Radio Setup, Radio Standard, LTE
Initial S/W Revision	A.09.50

BAND 9

Selects BAND 9 as the band for the current step.

Key Path	Source, List Sequencer, List Sequencer Setup, Radio Setup, Radio Standard, LTE
Initial S/W Revision	A.09.50

BAND 10

Selects BAND 10 as the band for the current step.

Key Path	Source, List Sequencer, List Sequencer Setup, Radio Setup, Radio Standard, LTE
Initial S/W Revision	A.09.50

BAND 11

Selects BAND 11 as the band for the current step.

Key Path	Source, List Sequencer, List Sequencer Setup, Radio Setup, Radio Standard, LTE
Initial S/W Revision	A.09.50

BAND 12

Selects BAND 12 as the band for the current step.

Key Path	Source, List Sequencer, List Sequencer Setup, Radio Setup, Radio Standard, LTE
Initial S/W Revision	A.09.50

BAND 13

Selects BAND 13 as the band for the current step.

Key Path	Source, List Sequencer, List Sequencer Setup, Radio Setup, Radio Standard, LTE
Initial S/W Revision	A.09.50

BAND 14

Selects BAND 14 as the band for the current step.

Key Path	Source, List Sequencer, List Sequencer Setup, Radio Setup, Radio Standard, LTE
Initial S/W Revision	A.09.50

BAND 17

Selects BAND 17 as the band for the current step.

Key Path	Source, List Sequencer, List Sequencer Setup, Radio Setup, Radio Standard, LTE
Initial S/W Revision	A.09.50

BAND 18

Selects BAND 18 as the band for the current step.

Key Path	Source, List Sequencer, List Sequencer Setup, Radio Setup, Radio Standard, LTE
Initial S/W Revision	A.09.50

BAND 19

Selects BAND 19 as the band for the current step.

Key Path	Source, List Sequencer, List Sequencer Setup, Radio Setup, Radio Standard, LTE
Initial S/W Revision	A.09.50

BAND 20

Selects BAND 20 as the band for the current step.

Key Path	Source, List Sequencer, List Sequencer Setup, Radio Setup, Radio Standard, LTE
Initial S/W Revision	A.09.50

BAND 21

Selects BAND 21 as the band for the current step.

Key Path	Source, List Sequencer, List Sequencer Setup, Radio Setup, Radio Standard, LTE
Initial S/W Revision	A.09.50

BAND 24

Selects BAND 24 as the band for the current step.

Key Path	Source, List Sequencer, List Sequencer Setup, Radio Setup, Radio Standard, LTE
Initial S/W Revision	A.09.50

BAND 25

Selects BAND 25 as the band for the current step.

Key Path	Source, List Sequencer, List Sequencer Setup, Radio Setup, Radio Standard, LTE
Initial S/W Revision	A.09.50

BAND 26

Selects BAND 26 as the band for the current step.

Key Path	Source, List Sequencer, List Sequencer Setup, Radio Setup, Radio Standard, LTE
Initial S/W Revision	A.12.53

BAND 27

Selects BAND 27 as the band for the current step.

Key Path	Source, List Sequencer, List Sequencer Setup, Radio Setup, Radio Standard, LTE
Initial S/W Revision	A.14.00

BAND 28

Selects BAND 28 as the band for the current step.

Key Path	Source, List Sequencer, List Sequencer Setup, Radio Setup, Radio Standard, LTE
Initial S/W Revision	A.14.00

BAND 31

Selects BAND 31 as the band for the current step.

Key Path	Source, List Sequencer, List Sequencer Setup, Radio Setup, Radio Standard, LTE
Initial S/W Revision	A.14.00

LTE TDD

Sets LTE TDD as the radio standard for use and accesses the LTE TDD specific channel band sub-menus..

Key Path	Source, Frequency, Radio Setup, Radio Standard
Initial S/W Revision	A.11.50

BAND 33

Selects BAND 33 as the band for the current step.

Key Path	Source, Frequency, Radio Setup, Radio Standard, LTE TDD
Example	:SOUR:FREQ:CHAN:BAND BAND33
Initial S/W Revision	A.11.50

BAND 34

Selects BAND 34 as the band for the current step.

Key Path	Source, Frequency, Radio Setup, Radio Standard, LTE TDD
Example	:SOUR:FREQ:CHAN:BAND BAND34
Initial S/W Revision	A.11.50

BAND 35

Selects BAND 35 as the band for the current step.

Key Path	Source, Frequency, Radio Setup, Radio Standard, LTE TDD
Example	:SOUR:FREQ:CHAN:BAND BAND35
Initial S/W Revision	A.11.50

BAND 36

Selects BAND 36 as the band for the current step.

Key Path	Source, Frequency, Radio Setup, Radio Standard, LTE TDD
Example	:SOUR:FREQ:CHAN:BAND BAND36
Initial S/W Revision	A.11.50

BAND 37

Selects BAND 37 as the band for the current step.

Key Path	Source, Frequency, Radio Setup, Radio Standard, LTE TDD
Example	:SOUR:FREQ:CHAN:BAND BAND37
Initial S/W Revision	A.11.50

BAND 38

Selects BAND 38 as the band for the current step.

Key Path	Source, Frequency, Radio Setup, Radio Standard, LTE TDD
Example	:SOUR:FREQ:CHAN:BAND BAND38
Initial S/W Revision	A.11.50

BAND 39

Selects BAND 39 as the band for the current step.

Key Path	Source, Frequency, Radio Setup, Radio Standard, LTE TDD
Example	:SOUR:FREQ:CHAN:BAND BAND39
Initial S/W Revision	A.11.50

BAND 40

Selects BAND 40 as the band for the current step.

Key Path	Source, Frequency, Radio Setup, Radio Standard, LTE TDD
Example	:SOUR:FREQ:CHAN:BAND BAND40
Initial S/W Revision	A.11.50

BAND 41

Selects BAND 41 as the band for the current step.

Key Path	Source, Frequency, Radio Setup, Radio Standard, LTE TDD
Example	:SOUR:FREQ:CHAN:BAND BAND41
Initial S/W Revision	A.11.50

BAND 42

Selects BAND 42 as the band for the current step.

Key Path	Source, Frequency, Radio Setup, Radio Standard, LTE TDD
Example	:SOUR:FREQ:CHAN:BAND BAND42
Initial S/W Revision	A.11.50

BAND 43

Selects BAND 43 as the band for the current step.

Key Path	Source, Frequency, Radio Setup, Radio Standard, LTE TDD
Example	:SOUR:FREQ:CHAN:BAND BAND43
Initial S/W Revision	A.11.50

BAND 44

Selects BAND 44 as the band for the current step.

Key Path	Source, List Sequencer, List Sequencer Setup, Radio Setup, Radio Standard, LTE TDD
Initial S/W Revision	A.14.00

TDSCDMA

Sets TDSCDMA as the radio standard for use and accesses the TDSCDMA specific channel band sub-menus..

Key Path	Source, Frequency, Radio Setup, Radio Standard
Initial S/W Revision	A.11.50

BAND A

Selects BAND A as the band for the current step.

Key Path	Source, Frequency, Radio Setup, Radio Standard, TDSCDMA
Example	:SOUR:FREQ:CHAN:BAND BANDA
Initial S/W Revision	A.11.50

BAND B

Selects BAND B as the band for the current step.

Key Path	Source, Frequency, Radio Setup, Radio Standard, TDSCDMA
Example	:SOUR:FREQ:CHAN:BAND BANDB
Initial S/W Revision	A.11.50

BAND C

Selects BAND C as the band for the current step.

Key Path	Source, Frequency, Radio Setup, Radio Standard, TDSCDMA
Example	:SOUR:FREQ:CHAN:BAND BANDC
Initial S/W Revision	A.11.50

BAND D

Selects BAND D as the band for the current step.

Key Path	Source, Frequency, Radio Setup, Radio Standard, TDSCDMA
Example	:SOUR:FREQ:CHAN:BAND BANDD
Initial S/W Revision	A.11.50

BAND E

Selects BAND E as the band for the current step.

Key Path	Source, Frequency, Radio Setup, Radio Standard, TDSCDMA
Example	:SOUR:FREQ:CHAN:BAND BANDE
Initial S/W Revision	A.11.50

BAND F

Selects BAND F as the band for the current step.

Key Path	Source, Frequency, Radio Setup, Radio Standard, TDSCDMA
Example	:SOUR:FREQ:CHAN:BAND BANDF
Initial S/W Revision	A.11.50

Radio Band Link

Allows you to specify the radio band link direction for the steps within the list sequence. The link is used in conjunction with the channel band and channel number to determine the output frequency.

When set to “Uplink”, the source will calculate the uplink frequency according to an uplink formula together with selected channel band and channel number. When set to “Downlink”, the source will calculate the downlink frequency according to a downlink formula together with selected channel band and channel number.

Key Path	Source, List Sequencer, List Sequencer Setup, Radio Setup
Remote Command	:SOURce:LIST:STEP[1] 2 3...1000:SETup:RADio:BAND:LINK DOWN UP :SOURce:LIST:STEP[1] 2 3...1000:SETup:RADio:BAND:LINK?

Example	:SOUR:LIST:STEP2:SET:RAD:BAND:LINK UP :SOUR:LIST:STEP2:SET:RAD:BAND:LINK?
Notes	SCPI is supported after A.09.40
Preset	DOWN
Range	DOWN UP
Initial S/W Revision	A.05.00

Channel

Allows you to specify the frequency of the current step via a channel number.

Key Path	Source, List Sequencer, List Sequencer Setup
Remote Command	:SOURce:LIST:STEP[1] 2 3...1000:SETup:CNFRfrequency <double> :SOURce:LIST:STEP[1] 2 3...1000:SETup:CNFRfrequency?
Example	:SOUR:LIST:STEP2:SET:CNFR 124 :SOUR:LIST:STEP2:SET:CNFR?
Notes	SCPI is supported after A.09.40. This SCPI is used to setup channel number or frequency setting, according to current Radio Band setting. If Radio Band is "NONE", then it's frequency. If Radio Band is not "NONE", then it's channel number.
Couplings	The channel number is coupled to the step frequency value. When the step frequency value is changed, the channel number will increase or decrease to match the new step frequency. If the step frequency is not at an exact match for a channel number, the nearest channel number is displayed, along with a greater than, or less than sign to indicate the frequency is above or below the channel number.
Preset	1
Min	0 (Please refer to for valid ranges.)
Max	10838 (Please refer to for valid ranges.)
Initial S/W Revision	A.05.00

Frequency

Allows you to specify a frequency value for the current step.

Key Path	Source, List Sequencer, List Sequencer Setup
Remote Command	:SOURce:LIST:STEP[1] 2 3...1000:SETup:CNFRfrequency <double> :SOURce:LIST:STEP[1] 2 3...1000:SETup:CNFRfrequency?
Example	:SOUR:LIST:STEP2:SET:CNFR 1GHz :SOUR:LIST:STEP2:SET:CNFR?
Notes	SCPI is supported after A.09.40.

	This SCPI is used to setup channel number or frequency setting, according to current Radio Band setting. If Radio Band is "NONE", then it's frequency. If Radio Band is not "NONE", then it's channel number.
Couplings	The frequency value is coupled to the channel band and number for the step, such that updates to the radio band and channel number will update the frequency value to the corresponding absolute frequency. The reverse is also true, changing the frequency value causes the value of the channel number to be updated.
Preset	1.00 GHz
Min	10.00 MHz
Max	Hardware Dependant: Option 503 = 3.6 GHz Option 504 = 3.9 GHz Option 506 = 6.00 GHz
Initial S/W Revision	A.05.00

Power

Allows you to specify a power value for the current step.

Key Path	Source, List Sequencer, List Sequencer Setup
Remote Command	:SOURce:LIST:STEP[1] 2 3...1000:SETup:AMPLitude <double> :SOURce:LIST:STEP[1] 2 3...1000:SETup:AMPLitude?
Example	:SOUR:LIST:STEP2:SET:AMPL -50dBm :SOUR:LIST:STEP2:SET:AMPL?
Notes	SCPI is supported after A.09.40
Notes	Amplitude corrections can be specified for use with the source. In the event of amplitude corrections being applied, the valid ranges for the RF power do not change dependant on the current amplitude correction setting. Instead, if the combination of RF power + amplitude correction is higher or lower than the source output range, the Source Unleveled bit is set and the "Source Unleveled" indicator will appear on status panel to indicate that the source cannot maintain the output power that has been requested. The multiport adapter RFIO TX ports and GPS ports cannot ensure power accuracy when power setting is lower than -130dBm, this power setting value is defined by the sum of RF Power setting and related amplitude correction value. But user settable value could be lower than this limit. When application detected there exists power setting lower than -130dBm on MPA RFIO TX ports, then popup warning message . When application detected there exists power setting lower than -130dBm on MPA GPS ports, then popup warning message . These are only warning messages, and check is performed when RF is ON.
Notes	The Min and Max value here defined UI settable amplitude range. This range is larger than actual amplitude range with level accuracy defined in spec.
Dependencies	The RF power is dependent on the RF output port and frequency, such that the current frequency and selected output port determine the valid range of power values.
Preset	-100 dBm

Min	The range of values depends on the current frequency and selected RF output port. Please refer to "RF Power" on page 627 and the table RF Power Range for the valid ranges.
Max	The range of values depends on the current frequency and selected RF output port. Please refer to "RF Power" on page 627 and the table RF Power Range for the valid ranges.
Initial S/W Revision	A.05.00

Waveform

Allows you access to the sub-menus for selecting the waveform to be played back during the current step. Pressing this key also changes the central display area to show the Waveform File Selection view.

Key Path	Source, List Sequencer, List Sequencer Setup
Remote Command	:SOURce:LIST:STEP[1] 2 3...1000:SETup:WAVeform <string> :SOURce:LIST:STEP[1] 2 3...1000:SETup:WAVeform?
Example	:SOUR:LIST:STEP2:SET:WAV "CW" :SOUR:LIST:STEP2:SET:WAV?
Notes	SCPI is supported after A.09.40
Remote Command Notes	String type, takes "Off" "CW" "Cont" "waveform name"
Preset	CW
Range	Waveform Continue Previous CW Off
Initial S/W Revision	A.05.00

CW

Sets the current step to output a CW tone.

Key Path	Source, List Sequencer, List Sequencer Setup, Waveform
Example	:SOUR:LIST:STEP2:SET:WAV "CW"
Notes	SCPI is supported after A.09.40
Initial S/W Revision	A.05.00

Selected Waveform

Inserts the currently selected waveform in the waveform selection view as the waveform for playback during the current step.

Key Path	Source, List Sequencer, List Sequencer Setup, Waveform
Example	:SOUR:LIST:STEP2:SET:WAV "waveform name"
Notes	SCPI is supported after A.09.40 If the selected waveform contains header (which contains ARB play parameters), source list

sequence will automatically apply header settings of the selected waveform in that step.

Initial S/W Revision A.05.00

Continue Previous

Sets the current step to continue with playback of the waveform from the previous step. When continuing the previous waveform, the ARB playback will not pause while the source retunes to the new frequency or amplitude that may be defined for the new step.

Key Path **Source, List Sequencer, List Sequencer Setup, Waveform**

Example :SOUR:LIST:STEP2:SET:WAV "Cont"

Notes SCPI is supported after A.09.40

Initial S/W Revision A.05.00

Off

Disable RF output of the current step.

Key Path **Source, List Sequencer, List Sequencer Setup, Waveform**

Example :SOUR:LIST:STEP2:SET:WAV "Off"

Notes SCPI is supported after A.09.40

Initial S/W Revision A.05.00

Segments on Hard Disk

Allows you access to the sub-menus for loading waveform segments from the hard disk into ARB memory. The default directory is: D: varb.

Pressing this key changes the current view to the Waveform Management View.

Key Path **Source, Modulation Setup, ARB, Select Waveform**

Initial S/W Revision A.05.00

Load Segment To ARB Memory

Allows you to load the selected file into ARB memory. On the front panel you select the file for loading to the ARB memory by highlighting the desired file in the list. Using the SCPI command, you specify the file name on the HDD.

"NVWFM" (none-volatile storage) MSUS (Mass Storage Unit Specifier) is supported in the memory subsystem because the ARB memory cannot be accessed directly. Therefore, files must be downloaded to the instrument hard disk and then loaded into the ARB memory. "NVWFM" MSUS will be mapped to the

default directory D: VARB. The SCPI command supports using either “NVWFM” MSUS or specifying a full path. For more information, see [Memory Subsystem \(Remote Command Only\)](#).

If a file of the same name already exists within ARB memory, it is overwritten. If you wish to load two segments of the same name, you must rename one of the segments before loading it into ARB memory. To rename a segment, you can either use Windows File Explorer, or the :MMEMory:COPY command.

Key Path	Source, Modulation Setup, ARB, Select Waveform, Segments on Hard Disk
Remote Command	:SOURce:RADio:ARB:LOAD <string>
Example	:SOUR:RAD:ARB:LOAD “D: VARB\testwaveform.bin” or :SOUR:RAD:ARB:LOAD “NVWFM:testwaveform.bin”
Notes	<p>Because loading the file involves a delay of unpredictable length, this command should be followed by the query *OPC?, which holds off subsequent commands until the loading operating is complete.</p> <p><string> – specifies the path name of the file to load from the HDD into ARB memory. It could be a <full path + filename>, or <“NVWFM” MSUS + colon + filename>.</p> <p>When in Sequence Analyzer mode, and Include Source is Yes, an attempt to load a file to ARB memory will be rejected with an error.</p> <p>When Include Source is No and if there is insufficient free ARB memory to load the selected waveform, an error is generated. .</p> <p>If you specify a file over SCPI, but the file is not at the specified location, an error is generated.</p> <p>If you try to load a waveform file but the file contains less than 500 IQ samples, an error is generated.</p> <p>If you try to load a Signal Studio waveform “*.wfm” which contains invalid waveform header, an error is generated.</p> <p>If the ARB is ON when you load a file to ARB memory or delete a file from ARB memory, the playing waveform segment may not keep phase continuity during the ARB memory operation. The waveform will be replayed after the ARB operation is finished.</p> <p>ARB can be loaded into ARB memory even required licenses do not present on the instrument. In this case, a GUI only warning message –800, “Operation complete; Loaded <filename> successfully, but no license <required licenses> installed”. User can install required licenses according to <required licenses> string to license it, or multi-pack license it.</p>
Initial S/W Revision	A.05.00

Load All To ARB Memory

Allows you to load all the segment files within the currently selected directory into ARB memory. If a file of the same name already exists within ARB memory, it is overwritten. If you wish to load two segments of the same name, you must rename one of the segments before loading it into ARB memory. To rename a segment, you can either use Windows File Explorer, or the :MEMory:COPY command.

Key Path	Source, Modulation Setup, ARB, Select Waveform, Segments on Hard Disk
Remote Command	:SOURce:RADio:ARB:LOAD:ALL <string>
Example	:SOUR:RAD:ARB:LOAD:ALL “D: varb”
Notes	<p><string> - specifies the directory on the HDD to load the files into ARB memory from.</p> <p>When in Sequence Analyzer mode, and Include Source is Yes, an attempt to load all files from a</p>

directory to ARB memory is rejected with an error.
 When Include Source is No and there is insufficient free ARB memory to load all the waveforms, when the ARB memory is full, the copy ceases, and an error is generated.
 If you specify a directory over SCPI, but the directory does not exist, an error is generated.
 If the ARB is ON, a user then loads or deletes file to ARB memory, the playing waveform segment may not keep phase continuity during the ARB memory operation. The waveform will be replayed after the ARB operation is finished.

Initial S/W Revision	A.05.00
----------------------	---------

Change Directory...

Allows you to change the currently selected directory on the hard disk. Pressing this key opens a standard windows change directory dialog allowing you to select the new directory of interest.

The current directory is used for manually loading waveform segments into ARB memory for playback, and as a search location for waveform segments that are required to be loaded into ARB memory for playback of a waveform sequence or a list sequence.

Key Path	Source, Modulation Setup, ARB, Select Waveform, Segments on Hard Disk
----------	--

Notes	No remote command, SCPIfront panel only.
-------	--

Initial S/W Revision	A.05.00
----------------------	---------

Default Directory...

Allows you to change the default directory. It is used as a search location for waveform segments that are required to be loaded into ARB memory for playback of a waveform sequence, and as a search location for selecting waveforms using SCPI.

Key Path	Source, Modulation Setup, ARB, Select Waveform, Segments on Hard Disk
----------	--

Remote Command	:SOURce:RADio:ARB:DEFault:DIRectory <string> :SOURce:RADio:ARB: DEFault:DIRectory?
-----------------------	---

Example	:SOUR:RAD:ARB:DEF:DIR "D:\ArbFiles" :SOUR:RAD:ARB:DEF:DIR?
----------------	---

State Saved	Persistent, survives a power cycle and a preset but not saved in the instrument state
-------------	---

Initial S/W Revision	A.05.00
----------------------	---------

Segments in ARB Memory

Allows you access to the sub-menus for managing the files within ARB memory.

Key Path	Source, Modulation Setup, ARB, Select Waveform
----------	---

Initial S/W Revision	A.05.00
----------------------	---------

Delete Segment From ARB Mem

Allows you to remove a segment from ARB playback memory.

Key Path	Source, Modulation Setup, ARB, Select Waveform, Segments in ARB Memory
Remote Command	:SOURce:RADio:ARB:DELeTe <string>
Example	:SOUR:RAD:ARB:DEL "testwaveform.bin"
Notes	<p><string> - specifies the waveform to be deleted from the ARB playback memory.</p> <p>When in Sequence Analyzer mode and Include Source is Yes, an attempt to delete a file from ARB memory is rejected with an error.</p> <p>When Include Source is No and you specify a file that does not exist within ARB memory, an error is generated.</p> <p>It is possible to delete files from within the ARB memory when the ARB is ON. However, if you attempt to delete the file that is currently playing an error is generated.</p> <p>It is possible to delete a file from within the ARB memory when the sequencer state is ON and the file is not being used by the List Sequencer. If you attempt to delete a file which is being used by the list sequencer, an error is generated.</p> <p>When sequencer state is On, even if ARB state is On, the selected waveform will not be played. In this case, if the selected waveform is not used in List Sequence, it can be deleted and the ARB state is turned Off.</p> <p>If the ARB is ON and you load a file to ARB memory or delete a file from ARB memory, the playing waveform segment may not keep phase continuity during the ARB memory operation. The waveform will be replayed after the ARB operation is finished.</p>
Initial S/W Revision	A.05.00

Delete All From ARB Memory

Allows you to remove all segments from ARB playback memory.

Key Path	Source, Modulation Setup, ARB, Select Waveform, Segments in ARB Memory
Remote Command	:SOURce:RADio:ARB:DELeTe:ALL
Example	:SOUR:RAD:ARB:DELeTe:ALL
Notes	<p>When in Sequence Analyzer mode and Include Source is Yes, an attempt to delete all files from ARB memory is rejected with an error.</p> <p>When Include Source is No and you attempt to delete all files from ARB memory when the ARB is currently playing a file, all files except the one playing are deleted and an error is generated.</p> <p>If you attempt to delete all files from ARB memory when there are waveform files used in "List Sequencer" on page 712 and "Sequencer" on page 713 state is ON, all files except the files currently being used in list sequencer are deleted, and an error is generated.</p> <p>If the ARB is ON and you load a file to ARB memory or delete a file from ARB memory, the playing waveform segment may not keep phase continuity during the ARB memory operation. The waveform will be replayed after the ARB operation is finished.</p>
Initial S/W Revision	A.05.00

Segments on Hard Disk

This key functions the same as ["Segments on Hard Disk" on page 738](#).

Key Path	Source, List Sequencer, List Sequencer Setup, Waveform
Initial S/W Revision	Prior to A.09.00

Load Segment To ARB Memory

This key functions the same as ["Load Segment To ARB Memory" on page 738](#).

Key Path	Source, List Sequencer, List Sequencer Setup, Waveform, Segment on Hard Drive
Initial S/W Revision	Prior to A.09.00

Load All To ARB Memory

This key functions the same as ["Load All To ARB Memory" on page 739](#).

Key Path	Source, List Sequencer, List Sequencer Setup, Waveform, Segment on Hard Drive
Initial S/W Revision	Prior to A.09.00

Change Directory ...

This key functions the same as ["Change Directory..." on page 740](#).

Key Path	Source, List Sequencer, List Sequencer Setup, Waveform, Segment on Hard Drive
Initial S/W Revision	Prior to A.09.00

Default Directory ...

This key functions the same as ["Default Directory..." on page 740](#)

Key Path	Source, List Sequencer, List Sequencer Setup, Waveform, Segment on Hard Drive
Initial S/W Revision	Prior to A.09.00

Segments in ARB Memory

This key functions the same as ["Segments in ARB Memory" on page 740](#).

Key Path	Source, List Sequencer, List Sequencer Setup, Waveform, Segments in ARB Memory
Initial S/W Revision	Prior to A.09.00

Delete Segment From ARB Memory

This key functions the same as "Delete Segment From ARB Mem" on page 741.

Key Path	Source, List Sequencer, List Sequencer Setup, Waveform, Segments in ARB Memory, Segment in ARB Memory
Initial S/W Revision	Prior to A.09.00

Delete All From ARB Memory

This key functions the same as "Delete All From ARB Memory" on page 741.

Key Path	Source, List Sequencer, List Sequencer Setup, Waveform, Segments in ARB Memory, Segment in ARB Memory
Initial S/W Revision	Prior to A.09.00

Step Duration

Allows access to the sub-menus for setting up the duration of play for the current step.

The duration can be set to be either the number of times for the ARB file associated with the sequence to play, or a specific time value, or continuous. If the step is set to play a CW tone, the step duration cannot be set to a play count.

Key Path	Source, List Sequencer, List Sequencer Setup
Remote Command	:SOURce:LIST:STEP[1] 2 3...1000:SETup:DURation:TYPE TIME COUNT CONTInuous CABort :SOURce:LIST:STEP[1] 2 3...1000:SETup:DURation:TYPE?
Example	:SOUR:LIST:STEP2:SET:DUR:TYPE TIME :SOUR:LIST:STEP2:SET:DUR:TYPE?
Notes	SCPI is supported after A.09.40
Notes	If "Step Duration" is set to "Time" or "Play Count" for the last step, the last step of ARB keeps playing as if set to "Continuous", until the set "Time" has expired or until the "Play Count" setting is reached. However, you can query Error! Reference source not found. Source Sweeping Condition Message to find out if the current list sequence is complete or not.
Range	Time Play Count Continuous Continuous Abort
Initial S/W Revision	A.05.00

Time

Sets the duration of the current step to be a time value for the length of time the step will play. Pressing this key again opens another menu which allows you to set the time value for the step duration.

Key Path	Source, List Sequencer, List Sequencer Setup, Step Duration
Example	:SOUR:LIST:STEP2:SET:DUR:TYPE TIME
Notes	SCPI is supported after A.09.40
Initial S/W Revision	A.05.00

Duration Time

Allows you to specify the length of time the current step will play.

When Step Duration is **Continuous Abort** this parameter specifies the maximum duration that the waveform will continue to play after a step trigger is received before the transition to the next waveform will occur. Duration is limited to a maximum of 20 seconds.

If the Transition Time value is longer than the Step Duration Time, an error is generated when initiating a source list sequence. For source list sequence, transition time is included in the step duration length (not occupy additional time). If the Transition Time value is longer than the Step Duration Time, the real step duration length is extended to equal the transition time and cause a timing shift. This check is also described in section **Error! Reference source not found.** List Sequence Step Validation.

Key Path	Source, List Sequencer, List Sequencer Setup, Step Duration, Time
Remote Command	:SOURce:LIST:STEP[1] 2 3...1000:SETup:DURation:TCOut <double> :SOURce:LIST:STEP[1] 2 3...1000:SETup:DURation:TCOut?
Example	:SOUR:LIST:STEP2:SET:DUR:TCO 1s :SOUR:LIST:STEP2:SET:DUR:TCO?
Notes	SCPI is supported after A.09.40 This SCPI is reused by "Play Count", "Duration Time" and "Continuous Abort" according to current Duration Type setting is "Play Count" or "Duration Time" or "Continuous Abort". If current "Duration Type" is "Continuous", then popup error -221, "Settings conflict; Cannot accept time or count input when step duration type is Continuous on step #"
Notes	If "Duration Time" is set for the last step, the last step of ARB keeps playing as if set to "Continuous" after set time expires. However, you can query Source Sweeping Condition Message (:STAT:OPER:COND?) to find out if the current list sequence is complete or not.
Preset	1.00 ms
Min	100 μs
Max	1800 s
Initial S/W Revision	A.05.00

Play Count

Sets the duration of the current step to be an integer value for the number of times (play count) the ARB file is selected for playback during this step. For example, a 5 second ARB will be set to play 5 times during the step.

Key Path	Source, List Sequencer, List Sequencer Setup, Step Duration
Example	:SOUR:LIST:STEP2:SET:DUR:TYPE COUN
Notes	SCPI is supported after A.09.40 This key is unavailable and is grayed out if the current step is configured to CW tone rather than an ARB waveform.
Initial S/W Revision	A.05.00

Header Utilities

Allows access to the header utilities sub-menu. Pressing this key also causes the central display area to change to display the File Header Information view.

Key Path	Source, Modulation Setup, ARB
Dependencies	This key is only available if there is currently a waveform selected for playback. If no waveform is selected, the key is grayed out.
Initial S/W Revision	A.05.00

Continuous

Sets the current step to be played continuously until the next step starts. The waveform will always play completely before transitioning to the next step.

Key Path	Source, List Sequencer, List Sequencer Setup, Step Duration
Example	:SOUR:LIST:STEP2:SET:DUR:TYPE CONT
Notes	SCPI is supported after A.09.40
Initial S/W Revision	A.05.00

Output Trigger

Allows you to specify the trigger output for the current step. The trigger output signal is sent at the start of the step.

When select “On”, trigger event will occur on both Internal and External2 paths. Select “Off” will turn off trigger output.

Key Path	Source, List Sequencer, List Sequencer Setup
Remote Command	:SOURce:LIST:STEP[1] 2 3...1000:SETup:OUTPut:TRIGger ON OFF 1 0 :SOURce:LIST:STEP[1] 2 3...1000:SETup:OUTPut:TRIGger
Example	:SOUR:LIST:STEP2:SET:OUTP:TRIG ON :SOUR:LIST:STEP2:SET:OUTP:TRIG?
Notes	SCPI is supported after A.09.40
Preset	Off

Range	On Off
Initial S/W Revision	A.05.00

Step Configuration (Remote Command Only)

This SCPI command is used to configure the List Sequencer and is detailed in the table below. The command is defined such that you send one command per step, with the step number being specified as a subopcode of the SCPI command. Each command includes all the parameter settings for the step. As a step is setup, the values entered are run through several levels of validation.

Remote Command	<pre>:SOURce:LIST:STEP[1] 2 ... 4..1000:SETup IMMEDIATE INTERNAL KEY BUS EXTERNAL2, <time>, NONE PGSM EGSM RGSM DCS1800 PCS1900 TGSM810 GSM450 GSM480 GSM700 GSM850 BANDI BANDII BANDIII BANDIV BANDV BANDVI BANDVII BANDVIII BANDIX BANDX BANDXI BANDXII BANDXIII BANDXIV BANDXIX USCELL USPCS JAPAN KOREAN NMT IMT2K UPPER SECOND PAMR400 PAMR800 IMTEXT PCS1DOT9G AWS US2DOT5G PUBLIC LOWER NONE BAND1 BAND2 BAND3 BAND4 BAND5 BAND6 BAND7 BAND8 BAND10 BAND11 BAND12 BAND13 BAND14 BAND17 BAND18 BAND19 BAND20 BAND21 BAND24 BAND25 BAND26 BAND33 BAND34 BAND35 BAND36 BAND37 BAND38 BAND39 BAND40 BAND41 BAND42 BAND43 BANDA BANDB BANDC BANDD BANDE BANDF, DOWN UP, <freq>, <ampl>, <string>, TIME COUNT CONTinuous, <time>, ON OFF 1 0, [<int>], :SOURce:LIST:STEP[1] 2 ... 4..1000:SETup?</pre>
Example	:SOUR:LIST:STEP1:SET INT, 1ms, PGSM, DOWN, 10, -25 dBm, "GSM_Test1.bin", TIME, 10ms, OFF, 255
Notes	<p>The parameters are:</p> <p>(There is a total of 11 items in each step, the following is a list of the items in the order they must appear in the remote command.)</p> <ol style="list-style-type: none"> 1. Step Trigger <enum> – specifies the input trigger for the step. For details of the valid types of step trigger see "Step Trigger" on page 715. 2. Transition Time <time> – specifies the transition time for the step in seconds. For details of the valid ranges for the transition time see "Transition Time" on page 717. 3. Radio Band <enum> – specifies the radio band for the step. For details of the valid radio bands see "Radio Setup" on page 718. 4. Radio Band Link <enum> – specifies the radio band link direction for the step. For details of the valid link types, see "Radio Band Link" on page 734. 5. Frequency/Channel Number <freq>/<chan num> – specifies the frequency in Hz or the channel number for the step. The channel number and frequency are combined as one parameter that represents the frequency or channel number depending on the radio band setting. If the radio band is set to NONE, this value is interpreted as a frequency value in Hz. If the radio band is set to a valid band, this value is interpreted as a channel number. For details of the valid ranges for frequency and channel numbers, see "Channel" on page 735 and "Frequency" on page 735. 6. Power <ampl> – specifies the output power for the step in dBm. For details of the valid ranges see "Power" on page 736. 7. Waveform <string> – specifies the waveform for playback during the step. The step can output either a new ARB waveform, continue playback of the previous waveform, or output a CW tone. The

options for specifying these are:

<filename> - plays the specified waveform from the start. The filename value is the name of the file within ARB playback memory, it does not include the windows path to the file on the HDD. If you enter a filename for a waveform that does not reside within ARB playback memory, an error is generated.

CONT - continues playback of the ARB file from the previous step

CW - outputs a CW tone

OFF - disable RF output

8. Step Duration <enum> - specifies the duration of the step. The duration can be specified to be either time, or play count of the ARB file associated with the step, or continuous. If Waveform is set to "CW", this value cannot be set to Play Count and an error will be generated. If continuous is selected, the following Time or Count value is ignored. For further details of this setting, see "[Step Duration](#)" on page 743.

9. Time or Count <time/int> - specifies time duration in seconds or play count of the ARB file associated with the step. For further details of this setting, including the valid ranges for the time or play count setting, "[Time](#)" on page 743 and "[Play Count](#)" on page 744.

10. Output Trigger <Boolean> - specifies the output trigger for the step. For details of the ranges for this setting see "[Output Trigger](#)" on page 745.

Dependencies	The range of subopcode values is 1 to 1000 and the value you enter is determined by the number of steps you have configured. For details see " Number of Steps " on page 714. If you attempt to remotely set or query a subopcode that is out of range, an error is generated.
Initial S/W Revision	A.05.00

Step Configuration of Step Trigger parameter list (Remote Command Only)

This SCPI command is to configure "Step Trigger" parameter array of the whole List Sequencer at one time. The number of array is same as step number defined in "[Number of Steps](#)" on page 714 Number of Steps. As a step is setup, the value entered run through several levels of validation.

Remote Command	:SOURce:LIST:SETup:INPut:TRIGger <enum>, <enum>, <enum>, ... :SOURce:LIST:SETup:INPut:TRIGger?
Example	:SOUR:LIST:SET:INP:TRIG IMM,INT,EXT2 :SOUR:LIST:SET:INP:TRIG?
Notes	The command is to setup below parameter array of whole list sequence. Step Trigger <enum> - specifies the input trigger for the step. For details of the valid types of step trigger see " Step Trigger " on page 715. If input parameter number exceeds the step number defined by " Number of Steps " on page 714 Number of Steps then generate error ", and only those parametes whose index number falls in number of steps will be updated.
Remote Command Notes	IMMediate INTernal KEY BUS EXTernal2
Dependencies	The range is 1 to 1000 which is determined by the number of steps you have configured. For details see " Number of Steps " on page 714.
Initial S/W Revision	A.09.40

Step Configuration of Transition Time parameter list (Remote Command Only)

This SCPI command is to configure “Transition Time” parameter array of the whole List Sequencer at one time. The number of array is same as step number defined in "Number of Steps" on page 714 Number of Steps. As a step is setup, the value entered run through several levels of validation.

Remote Command	:SOURce:LIST:SETup:TRANSition:TIME <time>, <time>, <time>, ... :SOURce:LIST:SETup:TRANSition:TIME?
Example	:SOUR:LIST:SET:TRAN:TIME 1ms,1ms,1ms :SOUR:LIST:SET:TRAN:TIME?
Notes	The command is to setup below parameter array of whole list sequence. Transition Time <time> – specifies the transition time for the step in seconds. For details of the valid ranges for the transition time see "Transition Time" on page 717 If input parameter number exceeds the step number defined by "Number of Steps" on page 714 Number of Steps then generate error ", and only those parametes whose index number falls in number of steps will be updated.
Dependencies	The range is 1 to 1000 which is determined by the number of steps you have configured. For details see "Number of Steps" on page 714.
Initial S/W Revision	A.09.40

Step Configuration of Radio Band parameter list (Remote Command Only)

This SCPI command is to configure “Radio Band” parameter array of the whole List Sequencer at one time. The number of array is same as step number defined in "Number of Steps" on page 714 Number of Steps. As a step is setup, the value entered run through several levels of validation.

R	:SOURce:LIST:SETup:RADio:BAND <enum>, <enum>, <enum>, ...
e	:SOURce:LIST:SETup:RADio:BAND?
m	
o	
t	
e	
C	
o	
m	
m	
a	
n	
d	
E	:SOUR:LIST:SET:RAD:BAND PGSM, EGSM, RGSM
X	:SOUR:LIST:SET:RAD:BAND?
a	
m	
p	
l	

e

N The command is to setup below parameter array of whole list sequence.

O Radio Band <enum> – specifies the radio band for the step. For details of the valid radio bands see ["Radio Setup" on page 718](#).

t If input parameter number exceeds the step number defined by ["Number of Steps" on page 714](#) Number of Steps then generate
e error ", and only those parametes whose index number falls in number of steps will be updated.
s

R NONE|PGSM|EGSM|RGSM|DCS1800|PCS1900|TGSM810|GSM450|GSM480|GSM700|GSM850|BANDI|BANDII|BANDIII|BANDI
e V|BANDV|BANDVI|BANDVII|BANDVIII|BANDIX|BANDX|BANDXI|BANDXII|BANDXIII|BANDXIV|BANDXIX|USCELL|USPCS|JAPAN|KO
m REAN|NMT|IMT2K|UPPER|SECOND|PAMR400|PAMR800|IMTEXT|PCS1DOT9G|AWS|US2DOT5G|PUBLIC|LOWER|NONE|BAND1|
o BAND2|BAND3|BAND4|BAND5|BAND6|BAND7|BAND8|BAND10|BAND11|BAND12|BAND13|BAND14|BAND17|BAND18|BAND1
t 9|BAND20|BAND21|BAND24|BAND25|BAND26|BAND33|BAND34|BAND35|BAND36|BAND37|BAND38|BAND39|BAND40|BAN
e D41|BAND42|BAND43|BANDA|BANDB|BANDC|BANDD|BANDE|BANDF

C
o
m
m
a
n
d

N
o
t
e
s

D The range is 1 to 1000 which is determined by the number of steps you have configured. For details see ["Number of Steps" on
e page 714](#).

p
e
n
d
e
n
c
i
e
s

I A.09.40

n
i
t
i
a
l

S
/
W

R
e
v
i
s
i
o
n

Step Configuration of Radio Band Link parameter list (Remote Command Only)

This SCPI command is to configure “Radio Band Link” parameter array of the whole List Sequencer at one time. The number of array is same as step number defined in ["Number of Steps" on page 714](#) Number of Steps. As a step is setup, the value entered run through several levels of validation.

Remote Command	:SOURce:LIST:SETup:RADio:BAND:LINK <enum>, <enum>, <enum>, ... :SOURce:LIST:SETup:RADio:BAND:LINK?
Example	:SOUR:LIST:SET:RAD:BAND:LINK DOWN,UP,UP :SOUR:LIST:SET:RAD:BAND:LINK?
Notes	The command is to setup below parameter array of whole list sequence. Radio Band Link <enum> – specifies the radio band link direction for the step. For details of the valid link types, see "Radio Band Link" on page 734 . If input parameter number exceeds the step number defined by "Number of Steps" on page 714 Number of Steps then generate error ", and only those parametes whose index number falls in number of steps will be updated.
Remote Command Notes	DOWN UP
Dependencies	The range is 1 to 1000 which is determined by the number of steps you have configured. For details see "Number of Steps" on page 714 .
Initial S/W Revision	A.09.40

Step Configuration of Frequency/Channel Number parameter list (Remote Command Only)

This SCPI command is to configure “Frequency” or “Channel Number” parameter array of the whole List Sequencer at one time. The number of array is same as step number defined in ["Number of Steps" on page 714](#) Number of Steps. As a step is setup, the value entered run through several levels of validation.

Remote Command	:SOURce:LIST:SETup:CNFfrequency <double>, <double>, <double>, ... :SOURce:LIST:SETup:CNFfrequency?
Example	:SOUR:LIST:SET:CNFR 1GHz,100MHz,100MHz :SOUR:LIST:SET:CNFR? SOUR:LIST:SET:CNFR 124,124,124 :SOUR:LIST:SET:CNFR?

Notes	<p>The command is to setup below parameter array of whole list sequence.</p> <p>Frequency/Channel Number <freq>/<chan num> – specifies the frequency in Hz or the channel number for the step. The channel number and frequency are combined as one parameter that represents the frequency or channel number depending on the radio band setting. If the radio band is set to NONE, this value is interpreted as a frequency value in Hz. If the radio band is set to a valid band, this value is interpreted as a channel number. For details of the valid ranges for frequency and channel numbers, see "Channel" on page 735 and "Frequency" on page 735</p> <p>This SCPI is used to setup/query channel number or frequency setting, according to current Radio Band setting of that step. If Radio Band is “NONE”, then it’s frequency. If Radio Band is not “NONE”, then it’s channel number</p> <p>If input parameter number exceeds the step number defined by "Number of Steps" on page 714 Number of Steps then generate error ", and only those parametes whose index number falls in legal step number will be updated.</p>
Dependencies	The range is 1 to 1000 which is determined by the number of steps you have configured. For details see "Number of Steps" on page 714 .
Initial S/W Revision	A.09.40

Step Configuration of Power parameter list (Remote Command Only)

This SCPI command is to configure “Power” parameter array of the whole List Sequencer at one time. The number of array is same as step number defined in ["Number of Steps" on page 714](#) Number of Steps. As a step is setup, the value entered run through several levels of validation.

Remote Command	<pre>:SOURce:LIST:SETup:AMPLitude <ampl>, <ampl>, <ampl>, ... :SOURce:LIST:SETup:AMPLitude?</pre>
Example	<pre>:SOUR:LIST:SET:AMPL -50dBm,-40dBm,-30dBm :SOUR:LIST:SET:AMPL?</pre>
Notes	<p>The command is to setup below parameter array of whole list sequence.</p> <p>Power <ampl> – specifies the output power for the step in dBm. For details of the valid ranges see "Power" on page 736.</p> <p>If input parameter number exceeds the step number defined by "Number of Steps" on page 714 Number of Steps then generate error ", and only those parametes whose index number falls in legal step number will be updated.</p>
Dependencies	The range is 1 to 1000 which is determined by the number of steps you have configured. For details see "Number of Steps" on page 714 .
Initial S/W Revision	A.09.40

Step Configuration of Waveform parameter list (Remote Command Only)

This SCPI command is to configure “Waveform” parameter array of the whole List Sequencer at one time. The number of array is same as step number defined in ["Number of Steps" on page 714](#) Number of Steps. As a step is setup, the value entered run through several levels of validation.

Remote Command	<pre>:SOURce:LIST:SETup:WAVEform <string>, <string>, <string>, ...</pre>
-----------------------	--

	:SOURce:LIST:SETup:WAVeform?
Example	:SOUR:LIST:SET:WAV "CW","Off","CONT" :SOUR:LIST:SET:WAV?
Notes	<p>The command is to setup below parameter array of whole list sequence.</p> <p>Waveform <string> – specifies the waveform for playback during the step. The step can output either a new ARB waveform, continue playback of the previous waveform, or output a CW tone. The options for specifying these are:</p> <p><filename> - plays the specified waveform from the start. The filename value is the name of the file within ARB playback memory, it is does not include the windows path to the file on the HDD. If you enter a filename for a waveform that does not reside within ARB playback memory, an error is generated.</p> <p>CONT – continues playback of the ARB file from the previous step</p> <p>CW – outputs a CW tone</p> <p>OFF – disable RF output</p> <p>If input parameter number exceeds the step number defined by "Number of Steps" on page 714 Number of Steps then generate error ", and only those parametes whose index number falls in number of steps will be updated.</p>
Dependencies	The range is 1 to 1000 which is determined by the number of steps you have configured. For details see "Number of Steps" on page 714.
Range	"filename" "CW" "Off" "CONT"
Initial S/W Revision	A.09.40

Step Configuration of Step Duration parameter list (Remote Command Only)

This SCPI command is to configure "Step Duration" parameter array of the whole List Sequencer at one time. The number of array is same as step number defined in "Number of Steps" on page 714 Number of Steps. As a step is setup, the value entered run through several levels of validation.

Remote Command	:SOURce:LIST:SETup:DURation:TYPE <enum>, <enum>, <enum>, ... :SOURce:LIST:SETup:DURation:TYPE?
Example	:SOUR:LIST:SET:DUR:TYPE COUN,TIME,CONT :SOUR:LIST:SET:DUR:TYPE?
Notes	<p>The command is to setup below parameter array of whole list sequence.</p> <p>Step Duration <enum> – specifies the duration of the step. The duration can be specified to be either time, or play count of the ARB file associated with the step, or continuous. If Waveform is set to "CW", this value cannot be set to Play Count and an error will be generated. If continuous is selected, the following Time or Count value is ignored. For further details of this setting, see "Step Duration" on page 743.</p> <p>If input parameter number exceeds the step number defined by "Number of Steps" on page 714 Number of Steps then generate error ", and only those parametes whose index number falls in number of steps will be updated.</p>
Remote Command Notes	TIME COUNT CONTInuous
Dependencies	The range is 1 to 1000 which is determined by the number of steps you have configured. For details

	see "Number of Steps" on page 714 .
Initial S/W Revision	A.09.40

Step Configuration of Duration Time or Play Count parameter list (Remote Command Only)

This SCPI command is to configure “Duration Time” or “Play Count” parameter array of the whole List Sequencer at one time. The number of array is same as step number defined in ["Number of Steps" on page 714](#) Number of Steps. As a step is setup, the value entered run through several levels of validation.

Remote Command	:SOURce:LIST:SETup:TOCount <time/int>, <time/int>, <time/int>, ... :SOURce:LIST:SETup:TOCount?
Example	:SOUR:LIST:SET:TOC 1s,2s,3s :SOUR:LIST:SET:TOC? :SOUR:LIST:SET:TOC 5,6,7 :SOUR:LIST:SET:TOC?
Notes	The command is to setup below parameter array of whole list sequence. Time or Count <time/int> – specifies time duration in seconds or play count of the ARB file associated with the step. For further details of this setting, including the valid ranges for the time or play count setting, "Time" on page 743 and "Play Count" on page 744 . If input parameter number exceeds the step number defined by "Number of Steps" on page 714 Number of Steps then generate error ", and only those parametes whose index number falls in number of steps will be updated. If current "Step Duration" on page 743 is “Continuous”, then generate error -221, "Settings conflict;Cannot accept time or count input when step duration type is Continuous on step #"
Dependencies	The range is 1 to 1000 which is determined by the number of steps you have configured. For details see "Number of Steps" on page 714 .
Initial S/W Revision	A.09.40

Step Configuration of Output Trigger parameter list (Remote Command Only)

This SCPI command is to configure “Output Trigger” parameter array of the whole List Sequencer at one time. The number of array is same as step number defined in ["Number of Steps" on page 714](#) Number of Steps. As a step is setup, the value entered run through several levels of validation.

Remote Command	:SOURce:LIST:SETup:OUTPut:TRIGger <bool>, <bool>, <bool>, ... :SOURce:LIST:SETup:OUTPut:TRIGger ?
Example	:SOUR:LIST:SET:OUTP:TRIG ON,OFF,ON :SOUR:LIST:SET:OUTP:TRIG?
Notes	The command is to setup below parameter array of whole list sequence. Output Trigger <Boolean> – specifies the output trigger for the step. For details of the ranges for this setting see "Output Trigger" on page 745 . If input parameter number exceeds the step number defined by "Number of Steps" on page 714 Number of Steps then generate error ", and only those parametes whose index number falls in

	legal step number will be updated.
Remote Command Notes	ON OFF 1 0
Dependencies	The range is 1 to 1000 which is determined by the number of steps you have configured. For details see " Number of Steps " on page 714.
Initial S/W Revision	A.09.40

Clear List (Remote Command Only)

This command is the SCPI equivalent of the Clear List UI feature described in.

Remote Command	:SOURce:LIST:SETup:CLEar
Example	:SOUR:LIST:SETup:CLE
Initial S/W Revision	A.05.00

Trigger Type

Allows access to the sub-menu for selecting the output trigger type for the list sequencer globally. It cannot be changed between different sequence steps.

Key Path	Source, List Sequencer
Remote Command	:SOURce:LIST:TRIGgerout:TYPE BEGinningofstep DATamarker
Example	:SOUR:LIST:TRIG:TYP BEG :SOUR:LIST:TRIG:TYP?
Notes	SCPI is supported after A.14.00 This an alias SCPI of :SOURce:LIST:TRIGger:OUTPut:TYPE STEP MARKer Recommend to use : SOURce:LIST:TRIGger:OUTPut:TYPE STEP MARKer
Preset	BEGinningofstep
Range	BEGinningofstep DATamarker
Initial S/W Revision	A.14.00

BeginningOfStep

Sets the output trigger type as BeginningOfStep for the whole source sequence.

Key Path	Source, List Sequencer, Trigger Type
Example	:SOUR:LIST:TRIG:TYP BEG
Notes	SCPI is supported after A.14.00 This an alias SCPI of :SOURce:LIST:TRIGger:OUTPut:TYPE STEP Recommend to use : SOURce:LIST:TRIGger:OUTPut:TYPE STEP

Initial S/W Revision	A.14.00
----------------------	---------

DataMarker

Sets the output trigger type as DataMarker for the whole source sequence. When DataMarker is selected, which marker to route is also needed to be set.

Key Path	Source, List Sequencer, Trigger Type
Example	:SOUR:LIST:TRIG:TYP DAT
Notes	SCPI is supported after A.14.00 This an alias SCPI of :SOURce:LIST:TRIGger:OUTPut:TYPE MARKer Recommend to use : SOURce:LIST:TRIGger:OUTPut:TYPE MARKer

Initial S/W Revision	A.14.00
----------------------	---------

Marker 1

Sets the output trigger maker routing to Marker 1 for DataMarker in the whole source sequence.

Key Path	Source, List Sequencer, Trigger Type, DataMarker
Example	:SOUR:LIST:TRIG:TYPE:MARK M1
Notes	SCPI is supported after A.14.00 This an alias SCPI of :SOURce:LIST:TRIGger:OUTPut:TYPE:MARKer M1 Recommend to use :SOURce:LIST:TRIGger:OUTPut:TYPE:MARKer M1

Initial S/W Revision	A.14.00
----------------------	---------

Marker 2

Sets the output trigger maker routing to Marker 2 for DataMarker in the whole source sequence.

Key Path	Source, List Sequencer, Trigger Type, DataMarker
Example	:SOUR:LIST:TRIG:TYPE:MARK M2
Notes	SCPI is supported after A.14.00 This an alias SCPI of :SOURce:LIST:TRIGger:OUTPut:TYPE:MARKer M2 Recommend to use :SOURce:LIST:TRIGger:OUTPut:TYPE:MARKer M2

Initial S/W Revision	A.14.00
----------------------	---------

Marker 3

Sets the output trigger maker routing to Marker 3 for DataMarker in the whole source sequence.

Key Path	Source, List Sequencer, Trigger Type, DataMarker
Example	:SOUR:LIST:TRIG:TYPE:MARK M3
Notes	SCPI is supported after A.14.00 This an alias SCPI of :SOURce:LIST:TRIGger:OUTPut:TYPE:MARKer M3 Recommend to use :SOURce:LIST:TRIGger:OUTPut:TYPE:MARKer M3
Initial S/W Revision	A.14.00

Marker 4

Sets the output trigger maker routing to Marker 4 for DataMarker in the whole source sequence.

Key Path	Source, List Sequencer, Trigger Type, DataMarker
Example	:SOUR:LIST:TRIG:TYPE:MARK M4
Notes	SCPI is supported after A.14.00 This an alias SCPI of :SOURce:LIST:TRIGger:OUTPut:TYPE:MARKer M4 Recommend to use :SOURce:LIST:TRIGger:OUTPut:TYPE:MARKer M4
Initial S/W Revision	A.14.00

Manual Trigger Now

Pressing this key provides a software trigger event to the list sequencer. During execution of sequence, if the sequencer is halted on any step that has been configured with a “Manual” step trigger, then this key press will cause the sequencer to continue and execute the step.

Key Path	Source, List Sequencer
Remote Command	No remote command, front panel only.
Initial S/W Revision	A.05.00

Remote Software Trigger (Remote command Only)

During execution of a list sequence, the sequence will halt and wait at any step that has Step Trigger set to “Bus”. Sending this command will trigger the step and continue the sequence.

Remote Command	:SOURce:LIST:TRIGger:INITiate[:IMMediate]
Example	:SOUR:LIST:TRIG:INIT
Initial S/W Revision	A.05.00

Query List Sequence Initiation Armed Status (Remote Command Only)

This is a blocking SCPI query to determine if source list sequence being initiated successfully or not.

Remote Command	:SOURce:LIST:INITiation:ARMed?
Example	:SOUR:LIST:INIT:ARMed?
Notes	The return data is in the following format: Integer
Notes	Query only SCPI. Returning "1" if list sequence has been initiated successfully, returning "0" if not. Once get "0", you can use :SYST:ERR? to query what error happened. Just like "*OPC?", this command can be blocked until event/status "IsSourceSweeping" happens, and then returns. Doing so can help user's script query armed status only once during the time interval of the initiation. As an ancillary SCPI of existing SCPI ":SOUR:LIST:TRIGger[:IMMediate]" (see "Initiate Sequence" on page 713 Initiate Sequence), the right usage of this command is to use it after ":SOUR:LIST:TRIG". If not, this command will return "1" immediately.
Notes	There is an alias SCPI ":SOURce:LIST:TRIGger:INITiation:ARMed?".
Initial S/W Revision	A.09.40

Source Preset

Allows you to preset the source settings to their default values.

Key Path	Source
Remote Command	:SOURce:PRESet
Example	:SOUR:PRES

Span X Scale

Accesses a menu of functions that enable you to set the horizontal scale parameters.

Key Path	Front-panel key
Initial S/W Revision	Prior to A.02.00

Ref Value

Sets the reference value for time on the horizontal axis. When Auto Scaling is set to On, the displayed plots use a Scale/Div value determined by the analyzer, based on the measurement result.

Key Path	SPAN X Scale
Mode	BASIC, PNOISE, WCDMA, C2K, GSM, WIMAXOFDMA, TDSCDMA, 1XEVD0, DVB, DTMB, ISDBT, CMMB, LTE, LTETDD, DCATV, WLAN, MSR,LTEATDD, LTEAFDD
Remote Command	:DISPlay:WAVeform:VIEW[1] 2:WINDow[1]:TRACe:X[:SCALE]:RLEVel <time> :DISPlay:WAVeform:VIEW[1] 2:WINDow[1]:TRACe:X[:SCALE]:RLEVel?
Example	DISP:WAV:VIEW:WIND:TRAC:X:RLEV 10 ms DISP:WAV:VIEW:WIND:TRAC:X:RLEV?
Notes	You must be in a mode that includes the Waveform measurement to use this command. Use INSTRument:SElect to set the mode.
Couplings	If Auto Scaling is set to On, this value is automatically determined by the measurement result. When you set this value manually, Auto Scaling automatically changes to Off.
Preset	0.00 s
State Saved	Saved in instrument state.
Min	-1.000 s
Max	10.00 s
Initial S/W Revision	Prior to A.02.00
Modified at S/W Revision	A.03.00

Scale/Div

Sets the horizontal scale by changing a time value per division.

Key Path	SPAN X Scale
Mode	BASIC, PNOISE, WCDMA, C2K, GSM, WIMAXOFDMA, TDSCDMA, 1XEVD0, DVB, DTMB, ISDBT, CMMB, LTE, LTETDD, DCATV, WLAN, MSR,LTEATDD, LTEAFDD
Remote Command	:DISPlay:WAVeform:VIEW[1] 2:WINDow[1]:TRACe:X[:SCALE]:PDIVision <time> :DISPlay:WAVeform:VIEW[1] 2:WINDow[1]:TRACe:X[:SCALE]:PDIVision?
Example	DISP:WAV:VIEW:WIND:TRAC:X:PDIV 500 us DISP:WAV:VIEW:WIND:TRAC:X:PDIV?

Notes	You must be in a mode that includes the Waveform measurement to use this command. Use INSTRUMENT:SElect to set the mode.
Couplings	If Auto Scaling is set to On, this value is automatically determined by the measurement result. When you set this value manually, Auto Scaling automatically changes to Off.
Preset	All except the following list: 200.0 us LTEAFDD, LTEATDD: 1.000 ms LTETDD: 1.000 ms LTE: 1.000 ms
State Saved	Saved in instrument state.
Min	1.000 ns
Max	320 s
Initial S/W Revision	Prior to A.02.00
Modified at S/W Revision	A.03.00, A.14.00

Ref Position

Sets the reference position for the X axis to Left, Center or Right.

Key Path	SPAN X Scale
Mode	BASIC, PNOISE, WCDMA, C2K, GSM, WIMAXOFDMA, TDSCDMA, 1XEVD0, DVB, DTMB, ISDBT, CMMB, LTE, LTETDD, DCATV, WLAN, MSR,LTEATDD, LTEAFDD
Remote Command	:DISPlay:WAVeform:VIEW[1] 2:WINDow[1]:TRACe:X[:SCALe]:RPOSition LEFT CENTER RIGHT :DISPlay:WAVeform:VIEW[1] 2:WINDow[1]:TRACe:X[:SCALe]:RPOSition?
Example	DISP:WAV:VIEW:WIND:TRAC:X:RPOS LEFT DISP:WAV:VIEW:WIND:TRAC:X:RPOS?
Notes	Allows you to set the reference position to Left, Ctr (center) or Right. You must be in a mode that includes the Waveform measurement to use this command. Use INSTRUMENT:SElect to set the mode.
Preset	LEFT
State Saved	Saved in instrument state.
Range	Left Ctr Right
Initial S/W Revision	Prior to A.02.00
Modified at S/W Revision	A.03.00

Auto Scaling

Toggles the scale coupling function between On and Off.

Key Path	SPAN X Scale
Mode	BASIC, PNOISE, WCDMA, C2K, GSM, WIMAXOFDMA, TDSCDMA, 1XEVD0, DVB, DTMB, ISDBT, CM MB, LTE, LTETDD, DCATV, WLAN, MSR,LTEATDD, LTEAFDD
Remote Command	:DISPlay:WAVeform:VIEW[1] 2:WINDow[1]:TRACe:X[:SCALE]:COUPle 0 1 OFF ON :DISPlay:WAVeform:VIEW[1] 2:WINDow[1]:TRACe:X[:SCALE]:COUPle?
Example	DISP:WAV:VIEW:WIND:TRAC:X:COUP ON DISP:WAV:VIEW:WIND:TRAC:X:COUP?
Notes	You must be in a mode that includes the Waveform measurement to use this command. Use INSTRument:SElect to set the mode.
Couplings	When Auto Scaling is On and the Restart front-panel key is pressed, this function automatically determines the scale per division and reference values based on the measurement results. When you set a value to either Scale/Div or Ref Value manually, Auto Scaling automatically changes to Off.
Preset	1
State Saved	Saved in instrument state.
Range	On Off
Initial S/W Revision	Prior to A.02.00
Modified at S/W Revision	A.03.00

Sweep/Control

Accesses a menu that enables you to configure the Sweep and Control functions of the analyzer, such as Acquisition Time and Gating.

Key Path	Front-panel key
Initial S/W Revision	Prior to A.02.00

Pause/Resume

Pauses a measurement after the current data acquisition is complete.

When Paused, the label on the key changes to Resume. Pressing Resume un-pauses the measurement. When you are Paused, pressing **Restart**, **Single** or **Cont** does a Resume.

Key Path	Sweep/Control
Remote Command	:INITiate:PAUSE
Dependencies	Grayed out in Measurements that do not support Pausing. Blanked in Modes that do not support Pausing.
Initial S/W Revision	Prior to A.02.00

Key Path	Sweep/Control
Remote Command	:INITiate:RESume
Dependencies	Grayed out in Measurements that do not support Pausing. Blanked in Modes that do not support Pausing.
Initial S/W Revision	Prior to A.02.00

Abort (Remote Command Only)

This command is used to stop the current measurement. It aborts the current measurement as quickly as possible, resets the sweep and trigger systems, and puts the measurement into an "idle" state. If the analyzer is in the process of aligning when ABORT is sent, the alignment finishes before the abort function is performed. So ABORT does not abort an alignment.

If the analyzer is set for Continuous measurement, it sets up the measurement and initiates a new data measurement sequence with a new data acquisition (sweep) taken once the trigger condition is met.

If the analyzer is set for Single measurement, it remains in the "idle" state until an :INIT:IMM command is received.

Remote Command	:ABORt
Example	:ABOR

Notes	<p>If :INITiate:CONTinuous is ON, then a new continuous measurement will start immediately, with sweep (data acquisition) occurring once the trigger condition has been met.</p> <p>If :INITiate:CONTinuous is OFF, then :INITiate:IMMEDIATE is used to start a single measurement; with sweep (data acquisition) occurring once the trigger condition has been met.</p>
Dependencies	<p>For continuous measurement, ABORt is equivalent to the Restart key.</p> <p>Not all measurements support the abort command.</p>
Status Bits/OPC dependencies	<p>The STATus:OPERation register bits 0 through 8 are cleared.</p> <p>The STATus:QUEStionable register bit 9 (INTegrity sum) is cleared.</p> <p>Since all the bits that feed into OPC are cleared by the ABORt, the ABORt will cause the *OPC query to return true.</p>
Initial S/W Revision	Prior to A.02.00

System

See "System" on page 166

Trace/Detector

There is no Trace/Detector functionality supported in the Waveform measurement. The front-panel key displays a blank menu when pressed.

Key Path	Front-panel key
Initial S/W Revision	Prior to A.02.00

Trigger

See ["Trigger" on page 220](#)

Free Run

See ["Free Run " on page 227](#)

Video

See ["Video \(IF Envelope\) " on page 228](#)

Trigger Level

See ["Trigger Level " on page 228](#)

Trig Slope

See ["Trig Slope " on page 229](#)

Trig Delay

See ["Trig Delay " on page 230](#)

External 1

See ["External 1 " on page 246](#)

Trigger Level

See ["Trigger Level " on page 247](#)

Trig Slope

See ["Trig Slope " on page 247](#)

Trig Delay

See ["Trig Delay " on page 233](#)

Zero Span Delay Comp

See ["Zero Span Delay Comp On/Off" on page 234](#)

External 2

See ["External 2 " on page 248](#)

Trigger Level

See ["Trigger Level " on page 248](#)

Trig Slope

See ["Trig Slope " on page 249](#)

Trig Delay

See ["Trig Delay "](#) on page 236

Zero Span Delay Comp

See ["Zero Span Delay Comp On/Off"](#) on page 236

RF Burst

See ["RF Burst "](#) on page 249

Absolute Trigger

See ["Absolute Trigger Level"](#) on page 250

Relative Trigger

See ["Relative Trigger Level"](#) on page 239

Trig Slope

See ["Trigger Slope "](#) on page 251

Trig Delay

See ["Trig Delay "](#) on page 240

Periodic Timer

See ["Periodic Timer \(Frame Trigger\) "](#) on page 241

Period

See ["Period "](#) on page 242

Offset

See ["Offset "](#) on page 243

Offset Adjust (Remote Command Only)

See ["Offset Adjust \(Remote Command Only\)"](#) on page 244

Reset Offset Display

See ["Reset Offset Display "](#) on page 245

Sync Source

See ["Sync Source "](#) on page 245

Off

See ["Off "](#) on page 246

External 1

See ["External 1 "](#) on page 246

Trigger Level

See ["Trigger Level "](#) on page 247

Trig Slope

See ["Trig Slope "](#) on page 247

External 2

See ["External 2 "](#) on page 248

Trigger Level

See ["Trigger Level "](#) on page 248

Trig Slope

See ["Trig Slope "](#) on page 249

RF Burst

See ["RF Burst "](#) on page 249

Absolute Trigger

See ["Absolute Trigger Level"](#) on page 250

Trig Slope

See ["Trigger Slope "](#) on page 251

Trig Delay

See ["Trig Delay"](#) on page 251

Auto/Holdoff

See ["Auto/Holdoff "](#) on page 252

Auto Trig

See ["Auto Trig "](#) on page 252

Trig Holdoff

See ["Trig Holdoff "](#) on page 253

Holdoff Type

See ["Holdoff Type"](#) on page 253

User Preset

Accesses a menu that gives you the following three choices:

- **User Preset** – recalls a state previously saved using the Save User Preset function.
- **User Preset All Modes** – presets all of the modes in the analyzer
- **Save User Preset**– saves the current state for the current mode

Key Path	Front-panel key
Backwards Compatibility Notes	<p>User Preset is actually loading a state, and in legacy analyzers, it was possible to load a state without affecting the trace data, limit lines or correction data. Similarly it was possible to do a User Preset without affecting the trace data, limit lines or correction data.</p> <p>In the X-Series, “state” always includes all of this data; so whenever state is loaded, or User Preset is executed, all of the traces, limit lines and corrections are affected. Although this differs from previous behavior, it is desirable behavior, and should not cause adverse issues for users.</p> <p>On ESA and PSA, User Preset affected the entire instrument’s state. In the X-Series, User Preset only recalls the state for the active mode. There is a User Preset file for each mode. User Preset can never cause a mode switch as it can in legacy analyzers. If you want to recall all modes to their user preset file state, you will need to do a User Preset after mode switching into each mode.</p> <p>User Preset recalls mode state which can now include data like traces; whereas on ESA and PSA, User Preset did not affect data.</p>
Initial S/W Revision	Prior to A.02.00

User Preset

User Preset sets the state of the currently active mode back to the state that was previously saved for this mode using the Save User Preset menu key or the SCPI command, `SYST:PRES:USER:SAV`. It not only recalls the Mode Preset settings, but it also recalls all of the mode persistent settings, and the Input/Output system setting that existed at the time Save User Preset was executed.

If a Save User Preset has not been done at any time, User Preset recalls the default user preset file for the currently active mode. The default user preset files are created if, at power-on, a mode detects there is no user preset file. There will never be a scenario when there is no user preset file to restore. For each mode, the default user preset state is the same state that would be saved if a Save User Preset is performed in each mode right after doing a Restore Mode Default and after a Restore Input/Output Defaults.

The User Preset function does the following:

- Aborts the currently running measurement.
- Sets the mode State to the values defined by Save User Preset.
- Makes the saved measurement for the currently running mode the active measurement.
- Brings up the saved menu for the power-on mode.
- Clears the input and output buffers.
- Sets the Status Byte to 0.

Key Path	User Preset
Remote Command	:SYSTem:PRESet:USER
Example	:SYST:PRES:USER:SAVE:SYST:PRES:USER
Notes	:SYST:PRES:USER:SAVE is used to save the current state as the user preset state. Clears all pending OPC bits. The Status Byte is set to 0. Pressing the User Preset front-panel key while already in the User Preset menu will cause the User Preset to get executed
Couplings	A user preset will cause the currently running measurement to be aborted and cause the saved measurement to be active. Recalling a User Preset file has the same issues that recalling a Save State file has. Some settings may need to be limited and therefore re-coupled, since the capabilities of the mode may have changes when the User Preset file was last saved.
Initial S/W Revision	Prior to A.02.00

User Preset All Modes

Recalls all of the User Preset files for each mode, switches to the power-on mode, and activates the saved measurement from the power-on mode User Preset file.

NOTE

When the instrument is secured, all of the user preset files are converted back to their default user preset files.

The User Preset function does the following:

- Aborts the currently running measurement.
- Switches the Mode to the power-on mode.
- Restores the User Preset files for each mode.
- Makes the saved measurement for the power-on mode the active measurement.
- Brings up the saved menu for the power-on mode.
- Clears the input and output buffers.
- Sets the Status Byte to 0.

Key Path	User Preset
Remote Command	:SYSTem:PRESet:USER:ALL
Example	:SYST:PRES:USER:SAVE:SYST:PRES:USER:ALL
Notes	Clears all pending OPC bits. The Status Byte is set to 0. :SYST:PRES:USER:SAVE is used to save the current state as the user preset state.
Couplings	A user preset will cause the currently running measurement to be aborted, cause a mode switch to the power-on mode, and cause the saved measurement to be active in the power-on mode. Recalling a User Preset file has the same issues that recalling a Save State file has. Some settings may need to be limited and therefore re-coupled, since the capabilities of the mode may have changes when the User Preset file was last saved.

Initial S/W Revision	Prior to A.02.00
----------------------	------------------

Save User Preset

Saves the currently active mode and its State. You can recall this User Preset file by pressing the User Preset menu key or sending the SYST:PRES:USER remote command. This same state is also saved by the Save State function.

Key Path	User Preset
Remote Command	:SYSTem:PRESet:USER:SAVE
Example	:SYST:PRES:USER:SAVE
Notes	:SYST:PRES:SAVE creates the same file as if the user requested a *SAV or a MMEM:STOR:STAT, except User Preset Save does not allow the user to specify the filename or the location of the file.
Initial S/W Revision	Prior to A.02.00

View/Display

Accesses a menu of functions that enable you to set up and control the display parameters for the current measurement.

This topic contains the following sections:

["View Selection by name \(Remote Command Only\)" on page 771](#)

["View Selection by number \(Remote Command Only\)" on page 771](#)

View Selection by name (Remote Command Only)

Selects the results view.

Key Path	View/Display
Mode	BASIC, PNOISE, WCDMA, C2K, GSM, WIMAXOFDMA, TDSCDMA, 1XEVDO, DVB, DTMB, ISDBT, CMMB, LTE, LTETDD, DCATV, WLAN, MSR, LTEATDD, LTEAFDD
Remote Command	:DISPlay:WAVeform:VIEW[:SElect] RFENvelope IQ :DISPlay:WAVeform:VIEW[:SElect]?
Example	DISP:WAV:VIEW RFEN DISP:WAV:VIEW?
Notes	You must be in a mode that includes the Waveform measurement to use this command. Use INSTRument:SElect to set the mode.
Preset	RFENveloper
State Saved	Saved in instrument state.
Range	RF Envelope IQ Waveform
Initial S/W Revision	Prior to A.02.00
Modified at S/W Revision	A.03.00

View Selection by number (Remote Command Only)

Displays the numeric values of the measurement results.

Mode	BASIC, PNOISE, WCDMA, C2K, GSM, WIMAXOFDMA, TDSCDMA, 1XEVDO, DVB, DTMB, ISDBT, CMMB, LTE, LTETDD, DCATV, WLAN, MSR, LTEATDD, LTEAFDD
Remote Command	:DISPlay:WAVeform:VIEW:NSElect <integer> :DISPlay:WAVeform:VIEW:NSElect?
Example	DISP:WAV:VIEW:NSEL 1 DISP:WAV:VIEW:NSEL?
Notes	You must be in a mode that includes the Waveform measurement to use this command. Use INSTRument:SElect to set the mode.
Preset	1
State Saved	Saved in instrument state.

Min	1
Max	2
Initial S/W Revision	Prior to A.02.00
Modified at S/W Revision	A.03.00

Key Path	Front-panel key
Initial S/W Revision	Prior to A.02.00

Display

The Display menu is common to most measurements, and is used for configuring items on the display. Some Display menu settings apply to all the measurements in a mode, and some only to the current measurement. Those under the **System Display Settings** key apply to all measurements in all modes.

Key Path	Display
Key Path	View/Display
Initial S/W Revision	Prior to A.02.00

Annotation

Turns on and off various parts of the display annotation. The annotation is divided up into four categories:

1. Meas Bar: This is the measurement bar at the top of the screen. It does not include the settings panel or the Active Function. Turning off the Meas Bar turns off the settings panel and the Active Function. When the Meas Bar is off, the graticule area expands to fill the area formerly occupied by the Meas Bar.
2. Screen Annotation: this is the annotation and annunciation around the graticule, including any annotation on lines (such as the display line, the threshold line, etc.) This does NOT include the marker number or the N dB result. When off, the graticule expands to fill the entire graticule area.
3. Trace annotation: these are the labels on the traces, showing their detector (or their math mode).
4. Active Function annotation: this is the active function display in the meas bar, and all of the active function values displayed on softkeys.

See the figure below. Each type of annotation can be turned on and off individually.

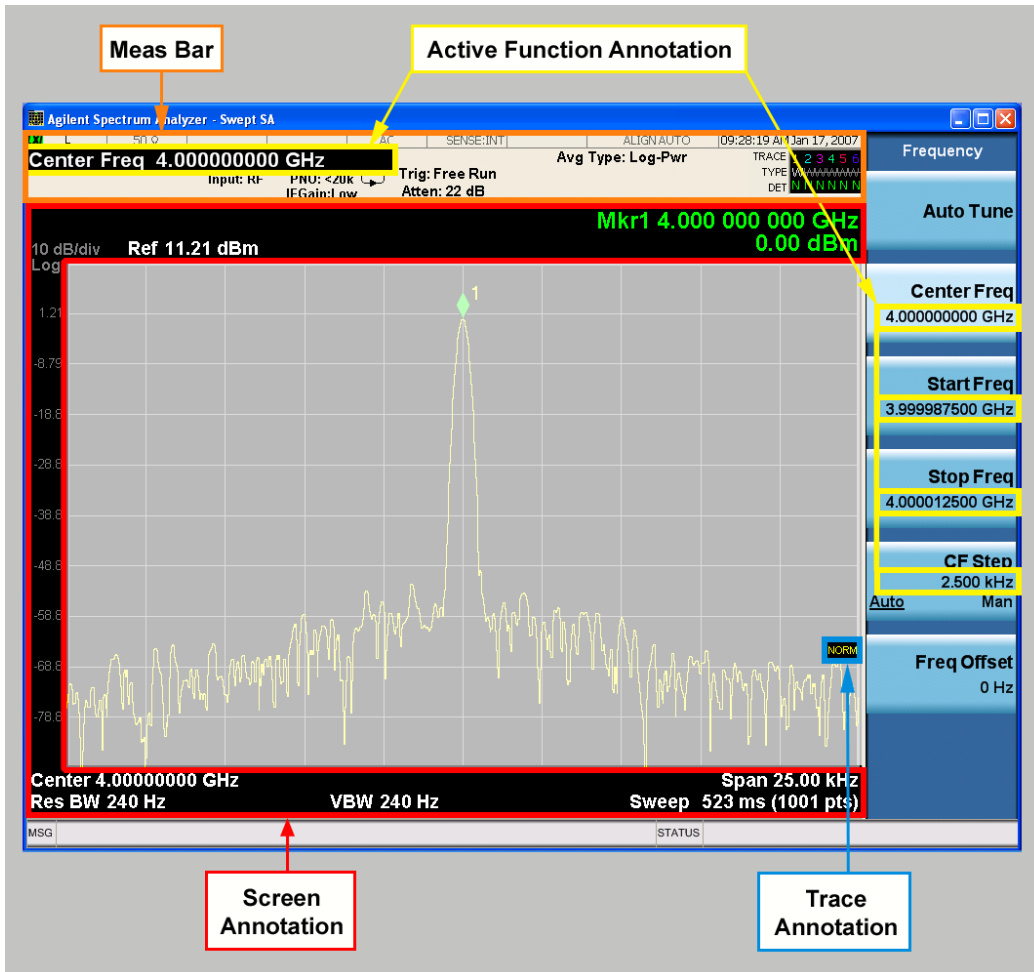

Key Path	View/Display, Display
Initial S/W Revision	Prior to A.02.00

Meas Bar On/Off

This function turns the Measurement Bar on and off, including the settings panel. When off, the graticule area expands to fill the area formerly occupied by the Measurement Bar.

Key Path	View/Display, Display, Annotation
Remote Command	:DISPlay:ANNotation:MBAR[:STATE] OFF ON 0 1 :DISPlay:ANNotation:MBAR[:STATE]?
Example	DISP:ANN:MBAR OFF
Dependencies	Grayed out and forced to OFF when System Display Settings, Annotation is set to Off.
Preset	On This should remain Off through a Preset when System DisplaySettings, Annotation is set to Off.

State Saved	Saved in instrument state.
Initial S/W Revision	Prior to A.02.00

Screen

This controls the display of the annunciation and annotation around the graticule, including any annotation on lines (such as the display line, the threshold line, etc.) and the y-axis annotation. This does NOT include marker annotation (or the N dB result). When off, the graticule expands to fill the entire graticule area, leaving only the 1.5% gap above the graticule as described in the Trace/Detector chapter.

Key Path	View/Display, Display, Annotation
Remote Command	:DISPlay:ANNotation:SCReen[:STATe] OFF ON 0 1 :DISPlay:ANNotation:SCReen[:STATe]?
Example	DISP:ANN:SCR OFF
Dependencies	Grayed-out and forced to OFF when System Display Settings, Annotation is set to Off.
Preset	On This should remain Off through a Preset when System DisplaySettings, Annotation is set to Off
State Saved	Saved in instrument state.
Initial S/W Revision	Prior to A.02.00

Active Function Values On/Off

Turns on and off the active function display in the Meas Bar, and all of the active function values displayed on the softkeys.

Note that all of the softkeys that have active functions have these numeric values blanked when this function is on. This is a security feature..

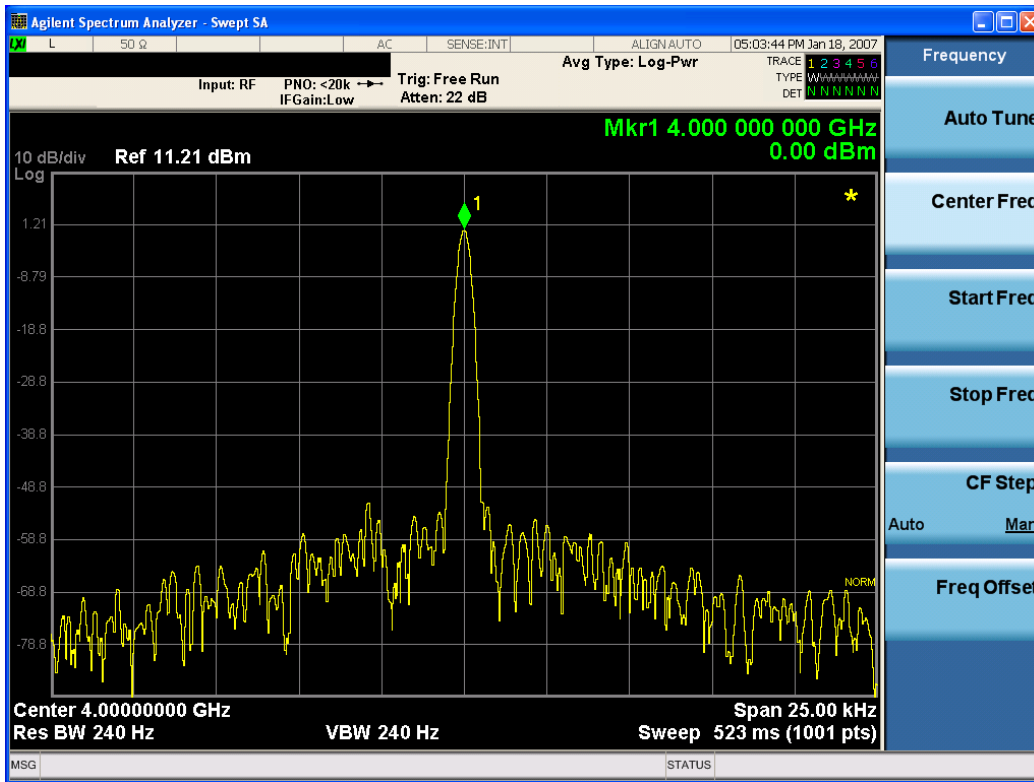

Key Path	View/Display, Display, Annotation
Remote Command	:DISPlay:ACTivefunc[:STATE] ON OFF 1 0 :DISPlay:ACTivefunc[:STATE]?
Example	DISP:ACT OFF
Dependencies	Grayed out and forced to OFF when System Display Settings, Annotation is set to Off.
Preset	On This should remain Off through a Preset when System DisplaySettings, Annotation is set to Off
State Saved	Saved in instrument state.
Initial S/W Revision	Prior to A.02.00

Title

Displays menu keys that enable you to change or clear a title on your display.

Key Path	View/Display, Display
Initial S/W Revision	Prior to A.02.00

Change Title

Writes a title into the "measurement name" field in the banner, for example, "Swept SA".

Press Change Title to enter a new title through the alpha editor. Press Enter or Return to complete the entry. Press ESC to cancel the entry and preserve your existing title.

The display title will replace the measurement name. It remains for this measurement until you press **Change Title** again, or you recall a state, or a Preset is performed. A title can also be cleared by pressing **Title, Clear Title**.

NOTE

Notice the inclusion of the <measurement> parameter in the command below. Because each measurement remembers the Display Title, the command must be qualified with the measurement name. For the Swept SA measurement this is not the case; no <measurement> parameter is used when changing the Display Title for the Swept SA measurement.

Key Path	View/Display, Display, Title
Mode	All
Remote Command	:DISPlay:<measurement>:ANNotation:TITLe:DATA <string> :DISPlay:<measurement>:ANNotation:TITLe:DATA?
Example	DISP:ANN:TITL:DATA "This Is My Title" This example is for the Swept SA measurement in the Spectrum Analyzer mode. The SANalyzer <measurement> name is not used. DISP:ACP:ANN:TITL:DATA "This Is My Title" This example is for Measurements other than Swept SA. Both set the title to: This Is My Title
Notes	Pressing this key cancels any active function. When a title is edited the previous title remains intact (it is not cleared) and the cursor goes at the end so that characters can be added or BKSP can be used to go back over previous characters.
Preset	No title (measurement name instead)
State Saved	Saved in instrument state.
Initial S/W Revision	Prior to A.02.00

Clear Title

Clears a title from the front-panel display. Once cleared, the title cannot be retrieved. After the title is cleared, the current Measurement Name replaces it in the title bar.

Key Path	View/Display, Display, Title
Example	The following commands clear the title and restore the measurement's original title: DISP:ANN:TITL:DATA "" This example is for the Swept SA measurement in the Spectrum Analyzer mode. The SANalyzer <measurement> name is not used. DISP:ACP:ANN:TITL:DATA "" This example is for ACP; in measurements other than Swept SA the measurement name is required.
Notes	Uses the :DISPlay:<measurement>:ANNotation:TITLe:DATA <string> command with an empty string (in the Swept SA, the <measurement> is omitted).

Preset	Performed on Preset.
Initial S/W Revision	Prior to A.02.00

Graticule

Pressing Graticule turns the display graticule On or Off. It also turns the graticule y-axis annotation on and off.

Key Path	View/Display, Display
Remote Command	:DISPlay:WINDow[1]:TRACe:GRATicule:GRID[:STATe] OFF ON 0 1 :DISPlay:WINDow[1]:TRACe:GRATicule:GRID[:STATe]?
Example	DISP:WIND:TRAC:GRAT:GRID OFF
Notes	The graticule is the set of horizontal and vertical lines that make up the grid/divisions for the x-axis and y-axis.
Preset	On
State Saved	Saved in instrument state
Initial S/W Revision	Prior to A.02.00

System Display Settings

These settings are "Mode Global" – they affect all modes and measurements and are reset only by **Restore Misc Defaults** or **Restore System Defaults** under System.

Key Path	View/Display, Display
Initial S/W Revision	Prior to A.02.00

Annotation Local Settings

This is a Mode Global override of the meas local annotation settings. When it is **All Off**, it forces **ScreenAnnotation, Meas Bar, Trace, and Active Function Values** settings to be **OFF** for all measurements in all modes. This provides the security based "annotation off" function of previous analyzers; hence it uses the legacy SCPI command.

When it is **All Off**, the **Screen, Meas Bar, Trace, and Active Function Values** keys under the **Display, Annotation** menu are grayed out and forced to **Off**. When **Local Settings** is selected, you are able to set the local annotation settings on a measurement by measurement basis.

Key Path	View/Display, Display, System Display Settings
Remote Command	:DISPlay:WINDow[1]:ANNOtation[:ALL] OFF ON 0 1 :DISPlay:WINDow[1]:ANNOtation[:ALL]?
Example	:DISP:WIND:ANN OFF

Preset	On (Set by Restore Misc Defaults)
State Saved	Not saved in instrument state.
Backwards Compatibility Notes	The WINDOW parameter and optional subopcode is included for backwards compatibility but ignored – all windows are equally affected.
Initial S/W Revision	Prior to A.02.00

Themes

Accesses a menu of functions that enable you to choose the theme to be used when saving the screen image.

The **Themes** option is the same as the **Themes** option under the **Display** and **Page Setup** dialogs. It allows you to choose between themes to be used when saving the screen image.

Key Path	Save, Screen Image
Remote Command	:MMEMory:STORe:SCReen:THEMe TDColor TDMonochrome FCOLor FMONochrome :MMEMory:STORe:SCReen:THEMe?
Example	:MMEM:STOR:SCR:THEM TDM
Preset	3D Color; Is not part of Preset, but is reset by Restore Misc Defaults or Restore System Defaults All and survives subsequent running of the modes.
Readback	3D Color 3D Mono Flat Color Flat Mono
Backwards Compatibility Notes	In ESA and PSA we offer the choice of "Reverse Bitmap" or "Reverse Metafile" when saving screen images. This is much like the "Flat Color" theme available in X-Series. Also, if you selected Reverse Bitmap AND a black & white screen image, that would be much like "Flat Monochrome". In other words, each of the X-Series themes has a similar screen image type in ESA/PSA. But they are not identical.
Initial S/W Revision	Prior to A.02.00

3D Color

Selects a standard color theme with each object filled, shaded and colored as designed.

Key Path	Save, Screen Image, Themes
Example	MMEM:STOR:SCR:THEM TDC
Readback	3D Color
Initial S/W Revision	Prior to A.02.00

3D Monochrome

Selects a format that is like 3D color but shades of gray are used instead of colors.

Key Path	Save, Screen Image, Themes
Example	MMEM:STOR:SCR:THEM TDM
Readback	3D Mono
Initial S/W Revision	Prior to A.02.00

Flat Color

Selects a format that is best when the screen is to be printed on an ink printer.

Key Path	Save, Screen Image, Themes
Example	MMEM:STOR:SCR:THEM FCOL
Readback	Flat Color
Initial S/W Revision	Prior to A.02.00

Flat Monochrome

Selects a format that is like Flat Color. But only black is used (no colors, not even gray), and no fill.

Key Path	Save, Screen Image, Themes
Example	MMEM:STOR:SCR:THEM FMON
Readback	Flat Mono
Initial S/W Revision	Prior to A.02.00

RF Envelope

This view shows an example of the RF Envelope result for the waveform (time domain) measurements in the graph window. The measured values for the mean power and peak-to-mean power are shown in the text window.

9 Waveform Measurement
View/Display

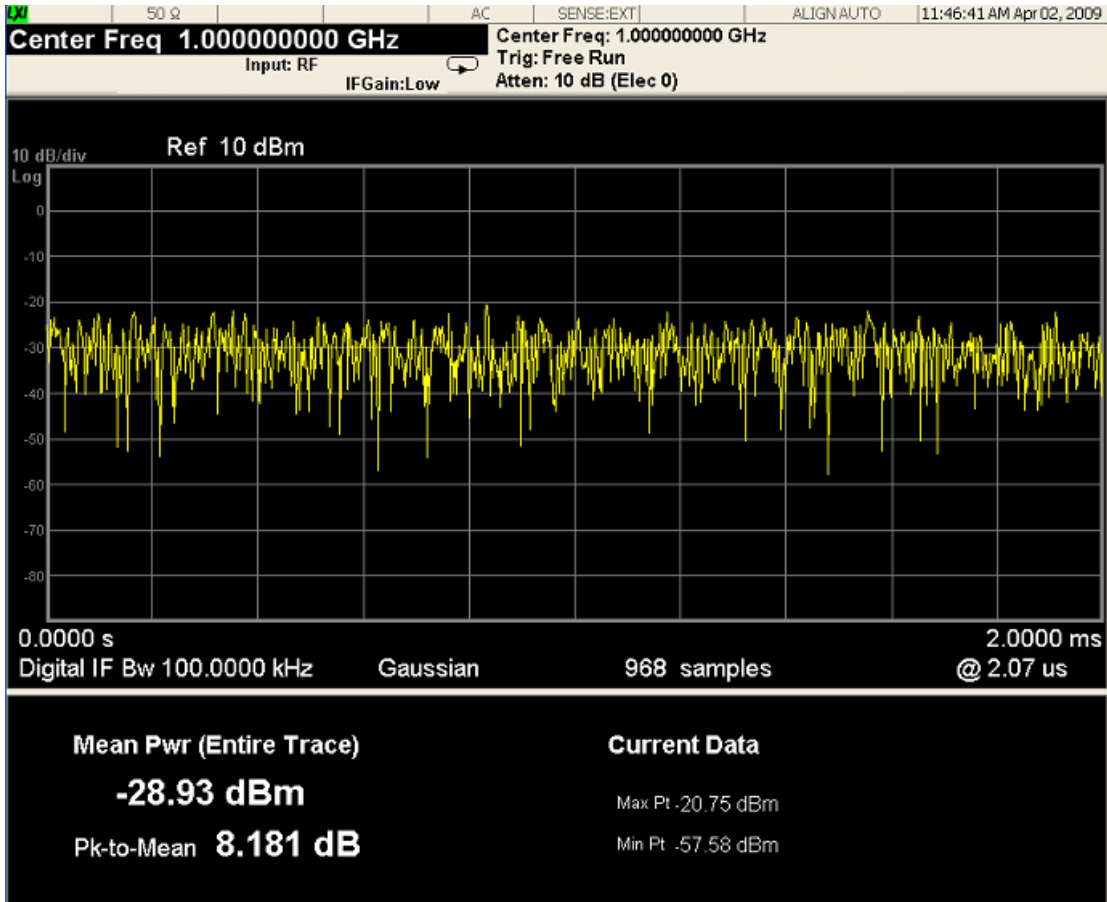

Numeric Results

Name	Type	Description	Unit	Format
Mean Pwr	Float64	The mean power (dBm). This is either the power across the entire trace, or the power between markers if the markers are enabled.	dBm	XX.XX dBm
Pk-to-Mean	Float64	This is the ratio of the maximum signal level to the mean power.	dB	XX.XX dB
Max Pt	Float64	The maximum of the most recently acquired data.	dBm	XX.XX dBm
Min Pt	Float64	The minimum of the most recently acquired data.	dBm	XX.XX dBm

Key Path	View/Display
Initial S/W Revision	Prior to A.02.00

I/Q Waveform

This view shows the I and Q signal waveforms in parameters of voltage versus time.

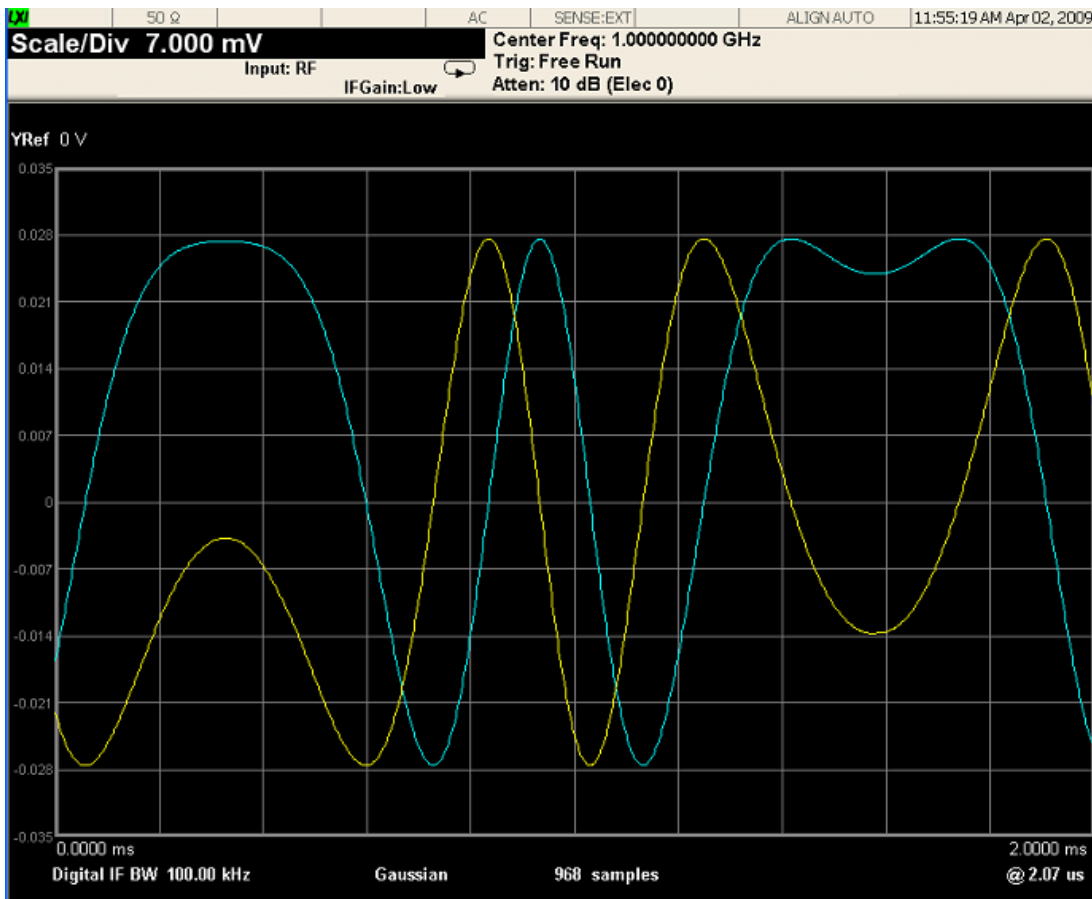

Key Path	View/Display
Initial S/W Revision	Prior to A.02.00



This information is subject to change without notice.

© Keysight Technologies 2014-2015

Edition 1, July 2015

V9060-90001

www.keysight.com